

63900-1 ✓ ACTIVE

FASTON | FASTON 250

TE Internal #: 63900-1

PCB Terminals, Tab, Mating Tab Width .25 in [6.35 mm], PCB Hole Diameter 1.4 mm [.055 in], Through Hole - Solder, Tin Plating, Bag, FASTON 250

[View on TE.com >](#)



Terminals & Splices > PCB Terminals

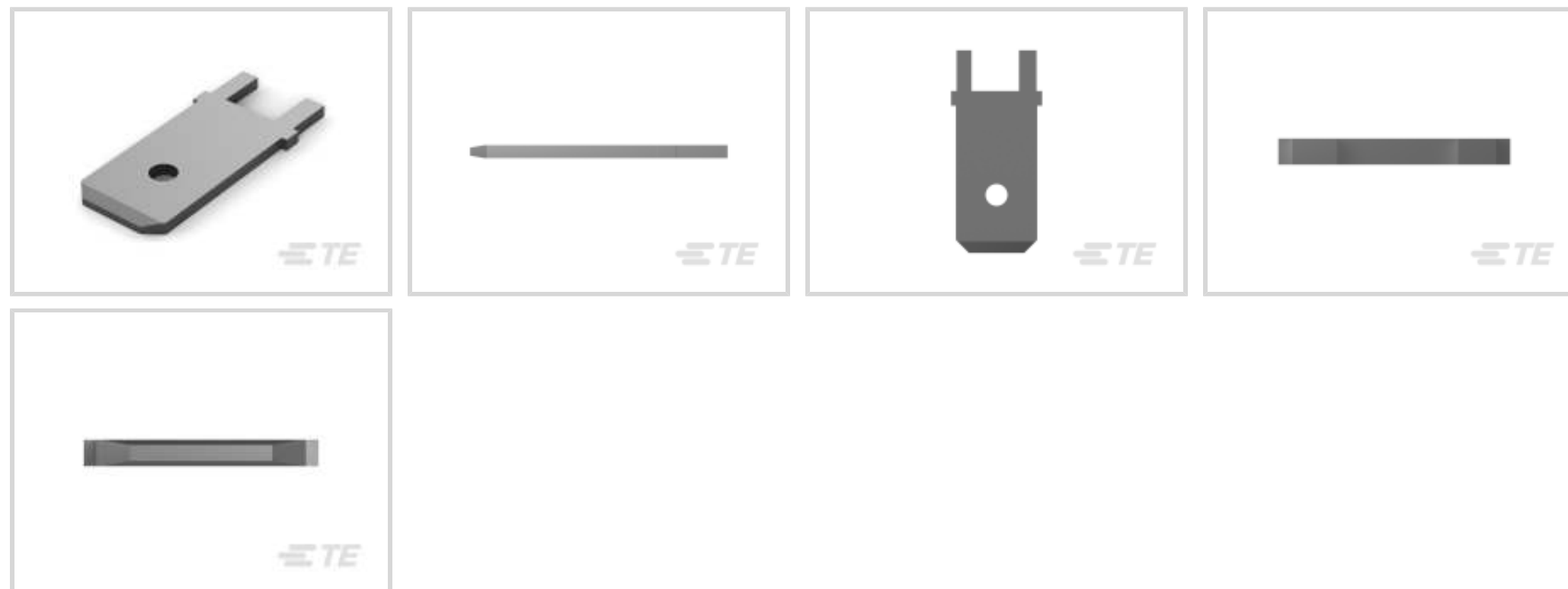

PCB Terminal Type: **Tab**

PCB Thickness (Recommended): **3.18 mm [.125 in]**

Mating Tab Width: **6.35 mm [.25 in]**

Mating Tab Thickness: **.81 mm [.032 in]**

PCB Hole Diameter: **1.4 mm [.055 in]**

Features

Contact Features

PCB Contact Termination Area Plating Material Thickness	3.81 μ m[150 μ in]
Contact Underplating Material Thickness	2.54 μ m[100 μ in]
Contact Mating Area Plating Material Thickness	3.81 μ m[150 μ in]
PCB Terminal Type	Tab
Mating Tab Width	6.35 mm[.25 in]
Mating Tab Thickness	.81 mm[.032 in]
Terminal Plating Material	Tin
Terminal Size	6.35
Terminal Orientation	Straight

Termination Features

Termination Method to Printed Circuit Board	Through Hole - Solder
Product Terminates To	Printed Circuit Board

Mechanical Attachment

Wire Insulation Support	With
-------------------------	------

Dimensions

Extension Below Board	3.18 mm[.125 in]
Terminal Material Thickness	.81 mm[.032 in]
PCB Thickness (Recommended)	3.18 mm[.125 in]
PCB Hole Diameter	1.4 mm[.055 in]
Profile Height from PCB	12.62 mm[.503 in]

Usage Conditions

Insulation Option	Uninsulated
Operating Temperature Range	-30 – 110 °C[-22 – 230 °F]

Packaging Features

Packaging Quantity	1000
Packaging Method	Bag

Product Compliance

















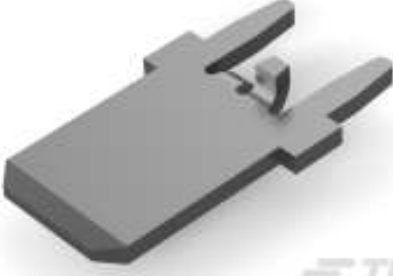

[For compliance documentation, visit the product page on TE.com>](#)

EU RoHS Directive 2011/65/EU	Compliant
EU ELV Directive 2000/53/EC	Compliant
China RoHS 2 Directive MIIT Order No 32, 2016	No Restricted Materials Above Threshold
EU REACH Regulation (EC) No. 1907/2006	Current ECHA Candidate List: JUNE 2023 (235) Candidate List Declared Against: JAN 2023 (233) Does not contain REACH SVHC
Halogen Content	Low Halogen - Br, Cl, F, I < 900 ppm per homogenous material. Also BFR/CFR/PVC Free
Solder Process Capability	Wave solder capable to 265°C

Product Compliance Disclaimer

This information is provided based on reasonable inquiry of our suppliers and represents our current actual knowledge based on the information they provided. This information is subject to change. The part numbers that TE has identified as EU RoHS compliant have a maximum concentration of 0.1% by weight in homogenous materials for lead, hexavalent chromium, mercury, PBB, PBDE, DBP, BBP, DEHP, DIBP, and 0.01% for cadmium, or qualify for an exemption to these limits as defined in the Annexes of Directive 2011/65/EU (RoHS2). Finished electrical and electronic equipment products will be CE marked as required by Directive 2011/65/EU. Components may not be CE marked. Additionally, the part numbers that TE has identified as EU ELV compliant have a maximum concentration of 0.1% by weight in homogenous materials for lead, hexavalent chromium, and mercury, and 0.01% for cadmium, or qualify for an exemption to these limits as defined in the Annexes of Directive 2000/53/EC (ELV). Regarding the REACH Regulation, the information TE provides on SVHC in articles for this part number is based on the latest European Chemicals Agency (ECHA) 'Guidance on requirements for substances in articles' posted at this URL: <https://echa.europa.eu/guidance-documents/guidance-on-reach>

Compatible Parts

 <p>TE Part # 63067-1 250 FASTON TAB TPBR</p>	 <p>TE Part # 735427-2 110 FASTON TAB TPBR</p>	 <p>TE Part # 1217169-1 250 FASTON,PCB TAB,TCBR</p>	 <p>TE Part # 61134-3 110 FASTON TAB TPBR</p>
 <p>TE Part # 62409-1 250 FASTON TAB TPBR</p>	 <p>TE Part # 1217057-1 187 FASTON,PCB TAB,TPBR</p>	 <p>TE Part # 1217167-1 250 FASTON,PCB TAB,TCBR</p>	 <p>TE Part # 1217056-1 250 FASTON,PCB TAB,TPBR</p>
 <p>TE Part # 63849-1 250 FASTON TAB TPBR</p>	 <p>TE Part # 1217756-1 187 FASTON,TAB,TNBR</p>	 <p>TE Part # 1742188-1 250 FASTON,PCB TAB,TCBR</p>	 <p>TE Part # 1742803-1 FASTON 312 PCB TAB TPBR</p>
 <p>TE Part # 62437-1 110 FASTON TAB TPBR</p>	 <p>TE Part # 1742686-1 250 FASTON,PCB TAB,TCBR</p>	 <p>TE Part # 1217754-1 250 FASTON,FLAG,PCB TAB,TNBR</p>	 <p>TE Part # 62262-1 250 FASTON TAB TPBR</p>
 <p>TE Part # 1-1217056-0 250 FASTON,PCB TAB,TPBR</p>	 <p>TE Part # 1217421-1 250 FASTON,PCB TAB,TNBR</p>	 <p>TE Part # 63849-4 250 FASTON TAB SPBR</p>	

Also in the Series | FASTON 250



Compression Connectors(4)

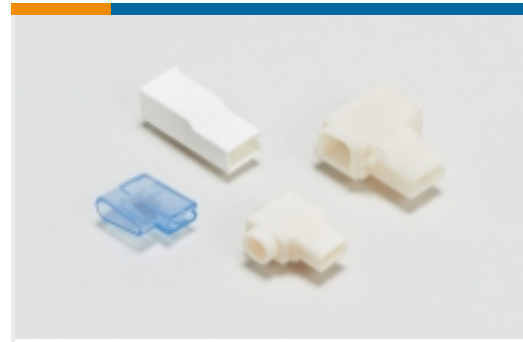

Crimp Terminal Housings(142)



Insertion & Extraction Tools(6)



Magnet Wire Terminals(1)



PCB Terminals(135)

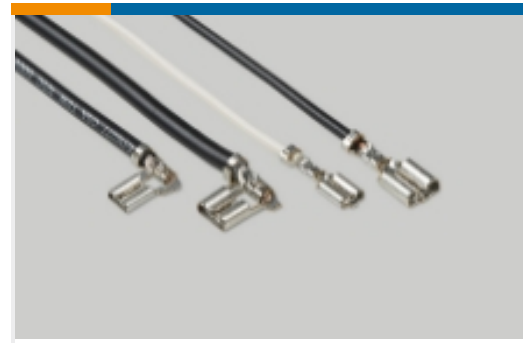

Quick Disconnects(445)



Splices(4)

Customers Also Bought

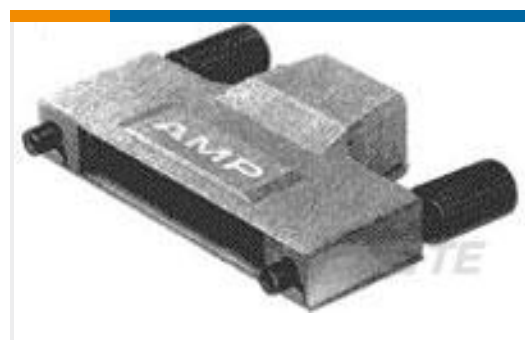

TE Part #5749080-1
50 50SR BSHLL KIT,M/J-SCR



TE Part #1SNK505911R0000
ES6-4S



TE Part #4-1768017-6
EET-0615P-4

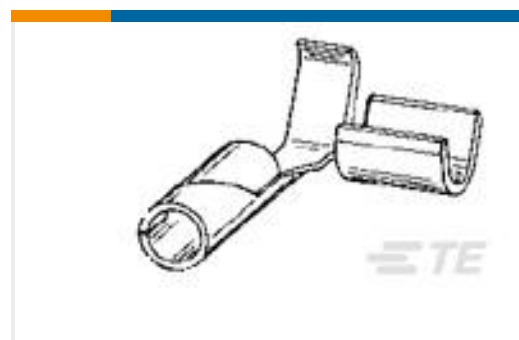

TE Part #160784-3
REC.FOR 2,5 DIA PIN



TE Part #1SNK506152R0000
ZS6-4S-PE



TE Part #CD87733001
CL105-0111-0.75-0



TE Part #8-22280-7
SPRING,COMPRESSION



TE Part #5420C-100-A-H-T
100 PSIA SO-8 PRESSURE SENSOR



TE Part #SM6841-100-A-H-T
100 PSIA SO-8 PRESSURE SENSOR



Documents

Product Drawings

250 FASTON TAB TPBR

English

CAD Files

3D PDF

3D

Customer View Model

[ENG_CVM_CVM_63900-1_G_c-63900-1-g.2d_dxf.zip](#)

English

Customer View Model

[ENG_CVM_CVM_63900-1_G_c-63900-1-g.3d_igs.zip](#)

English

Customer View Model

[ENG_CVM_CVM_63900-1_G_c-63900-1-g.3d_stp.zip](#)

English

By downloading the CAD file I accept and agree to the [Terms and Conditions](#) of use.

Datasheets & Catalog Pages

FASTON PCB Tabs and Receptacles

English

PRINTED CIRCUIT BOARD TERMINALS AND DISCONNECTS

English

Product Specifications

FASTON* 110, 187, 205, 250, and 312 Series Tab Contacts for Printed Circuit (PC) Board Applications

English

Product Environmental Compliance

Product Compliance

English

Product Compliance

English

Agency Approvals

CSA Certificate

English

CSA Certificate

English