

XPT IGBT

$V_{CES} = 1200V$

$I_{C25} = 38A$

$V_{CE(sat)} = 1.8V$

Copack

Part number

IXA20IF1200HB

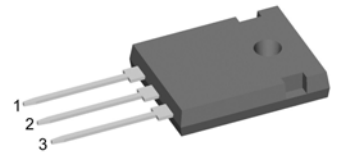

Backside: collector

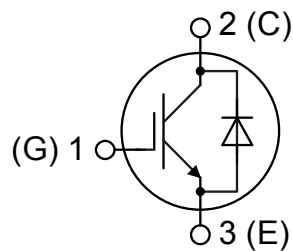
**Features / Advantages:**

- Easy paralleling due to the positive temperature coefficient of the on-state voltage
- Rugged XPT design (Xtreme light Punch Through) results in:
 - short circuit rated for 10 μ sec.
 - very low gate charge
 - low EMI
 - square RBSOA @ 3x I_c
- Thin wafer technology combined with the XPT design results in a competitive low $V_{CE(sat)}$
- SONIC™ diode
 - fast and soft reverse recovery
 - low operating forward voltage

Applications:

- AC motor drives
- Solar inverter
- Medical equipment
- Uninterruptible power supply
- Air-conditioning systems
- Welding equipment
- Switched-mode and resonant-mode power supplies
- Inductive heating, cookers
- Pumps, Fans

Package: TO-247

- Industry standard outline
- RoHS compliant
- Epoxy meets UL 94V-0

IGBT				Ratings					
Symbol	Definition	Conditions	min.	typ.	max.	Unit			
V_{CES}	collector emitter voltage	$T_{VJ} = 25^{\circ}C$			1200	V			
V_{GES}	max. DC gate voltage				± 20	V			
V_{GEM}	max. transient gate emitter voltage				± 30	V			
I_{C25}	collector current	$T_C = 25^{\circ}C$			38	A			
I_{C80}		$T_C = 80^{\circ}C$			22	A			
P_{tot}	total power dissipation	$T_C = 25^{\circ}C$			165	W			
$V_{CE(sat)}$	collector emitter saturation voltage	$I_C = 15A; V_{GE} = 15V$		1.8	2.1	V			
				2.1		V			
$V_{GE(th)}$	gate emitter threshold voltage	$I_C = 0.6mA; V_{CE} = V_{CE}$	5.4	5.9	6.5	V			
I_{CES}	collector emitter leakage current	$V_{CE} = V_{CES}; V_{GE} = 0V$			0.1	mA			
				0.1		mA			
I_{GES}	gate emitter leakage current	$V_{GE} = \pm 20V$			500	nA			
$Q_{G(on)}$	total gate charge	$V_{CE} = 600V; V_{GE} = 15V; I_C = 15A$		47		nC			
$t_{d(on)}$	turn-on delay time	inductive load $V_{CE} = 600V; I_C = 15A$ $V_{GE} = \pm 15V; R_G = 56\Omega$							
t_r	current rise time						$T_{VJ} = 125^{\circ}C$	70	ns
$t_{d(off)}$	turn-off delay time						40	ns	
t_f	current fall time						250	ns	
E_{on}	turn-on energy per pulse						100	ns	
E_{off}	turn-off energy per pulse						1.55	mJ	
E_{off}		1.7	mJ						
RBSOA	reverse bias safe operating area	$V_{GE} = \pm 15V; R_G = 56\Omega$							
I_{CM}		$V_{CEmax} = 1200V$			45	A			
SCSOA	short circuit safe operating area	$V_{CEmax} = 900V$							
t_{sc}	short circuit duration	$V_{CE} = 900V; V_{GE} = \pm 15V$			10	μs			
I_{sc}	short circuit current	$R_G = 56\Omega; \text{non-repetitive}$			60	A			
R_{thJC}	thermal resistance junction to case				0.76	K/W			
R_{thCH}	thermal resistance case to heatsink				0.25	K/W			
Diode									
V_{RRM}	max. repetitive reverse voltage	$T_{VJ} = 25^{\circ}C$			1200	V			
I_{F25}	forward current	$T_C = 25^{\circ}C$			45	A			
I_{F80}		$T_C = 80^{\circ}C$			24	A			
V_F	forward voltage	$I_F = 20A$			2.20	V			
					1.95	V			
I_R	reverse current	$V_R = V_{RRM}$			*	mA			
	* not applicable, see Ices value above				*	mA			
Q_{rr}	reverse recovery charge	$V_R = 600V$ $-di_F/dt = -400A/\mu s$ $I_F = 20A; V_{GE} = 0V$							
I_{RM}	max. reverse recovery current						$T_{VJ} = 125^{\circ}C$	3	μC
t_{rr}	reverse recovery time						20	A	
E_{rec}	reverse recovery energy						350	ns	
R_{thJC}	thermal resistance junction to case				0.9	K/W			
R_{thCH}	thermal resistance case to heatsink				0.25	K/W			

Package TO-247			Ratings			
Symbol	Definition	Conditions	min.	typ.	max.	Unit
I_{RMS}	RMS current	per terminal			70	A
T_{VJ}	virtual junction temperature		-40		150	°C
T_{op}	operation temperature		-40		125	°C
T_{stg}	storage temperature		-40		150	°C
Weight				6		g
M_D	mounting torque		0.8		1.2	Nm
F_C	mounting force with clip		20		120	N

Product Marking

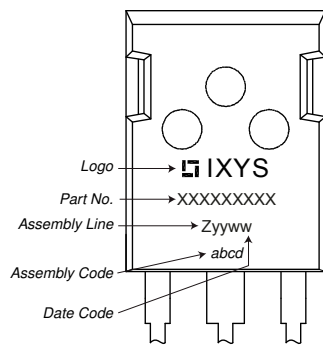

Part number

I = IGBT
 X = XPT IGBT
 A = Gen 1 / std
 20 = Current Rating [A]
 IF = Copack
 1200 = Reverse Voltage [V]
 HB = TO-247AD (3)

Ordering	Part Number	Marking on Product	Delivery Mode	Quantity	Code No.
Standard	IXA20IF1200HB	IXA20IF1200HB	Tube	30	508460

Similar Part	Package	Voltage class
IXA20I1200PB	TO-220AB (3)	1200

Equivalent Circuits for Simulation

* on die level

$T_{VJ} = 150\text{ °C}$

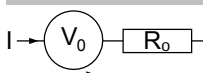

$V_{0\ max}$ threshold voltage

$R_{0\ max}$ slope resistance *

IGBT	Diode	
1.1	1.25	V
86	42.5	mΩ

Outlines TO-247

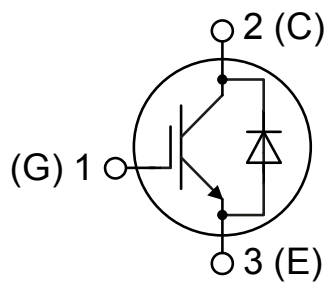
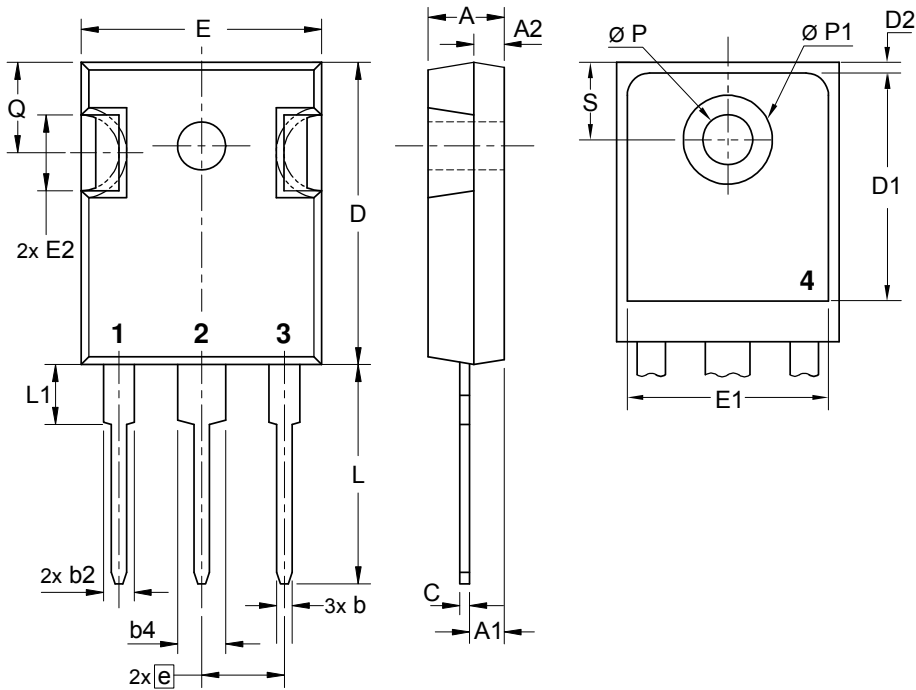

IGBT

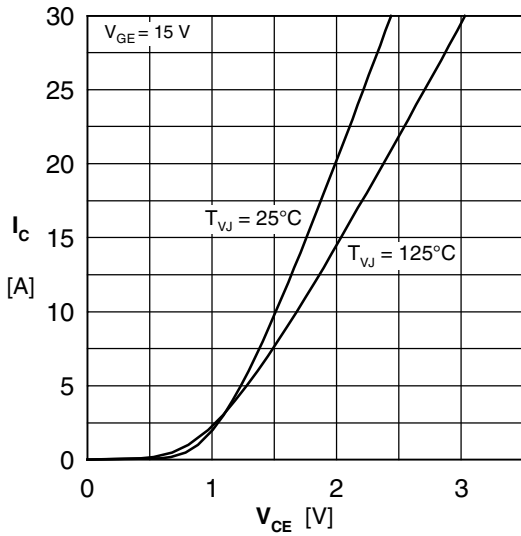

Fig. 1 Typ. output characteristics

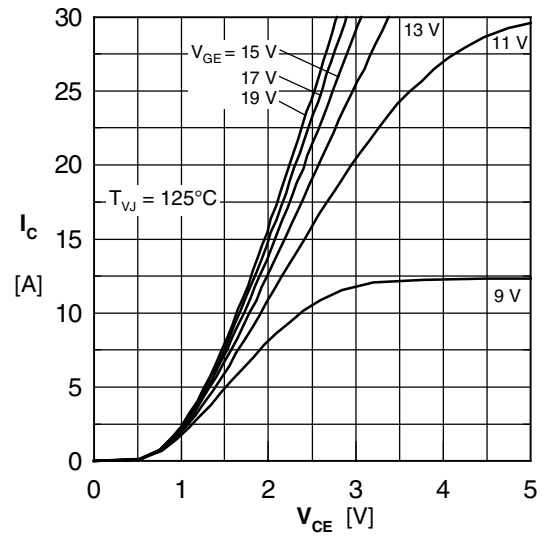

Fig. 2 Typ. output characteristics

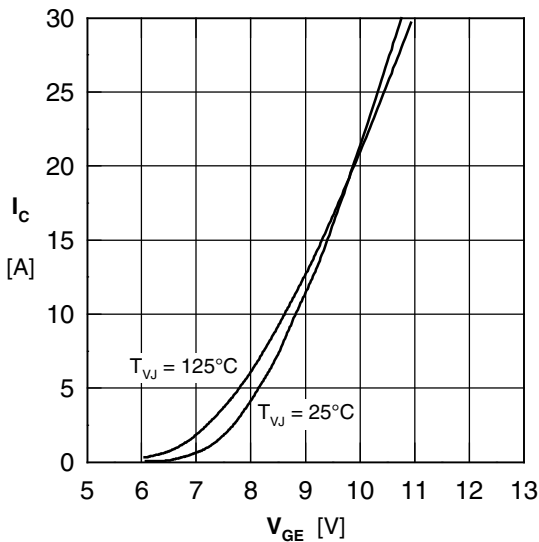

Fig. 3 Typ. transfer characteristics

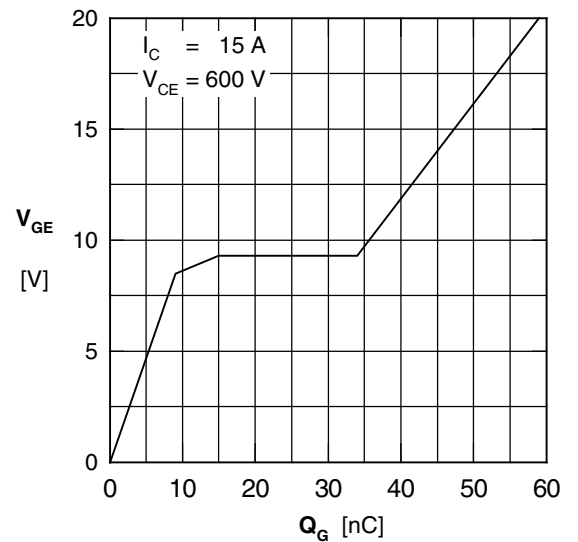

Fig. 4 Typ. turn-on gate charge

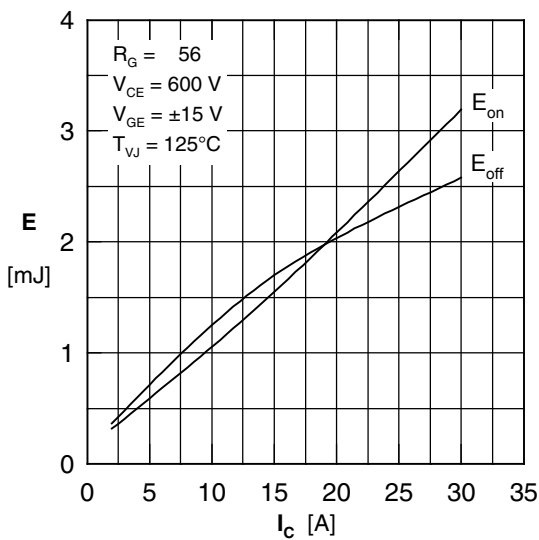

Fig. 5 Typ. switching energy vs. collector current

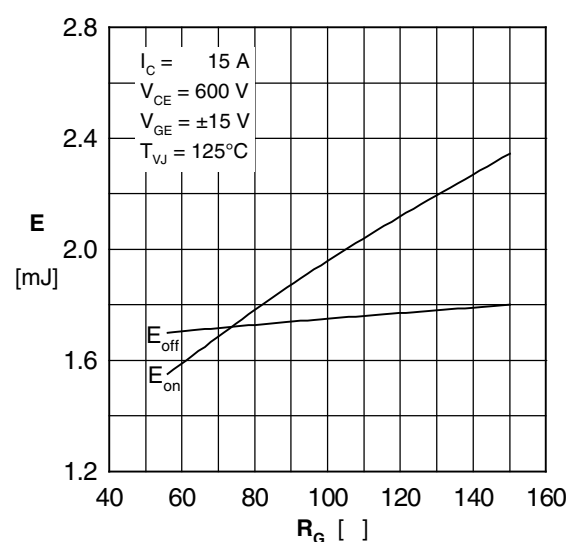

Fig. 6 Typ. switching energy vs. gate resistance

Diode

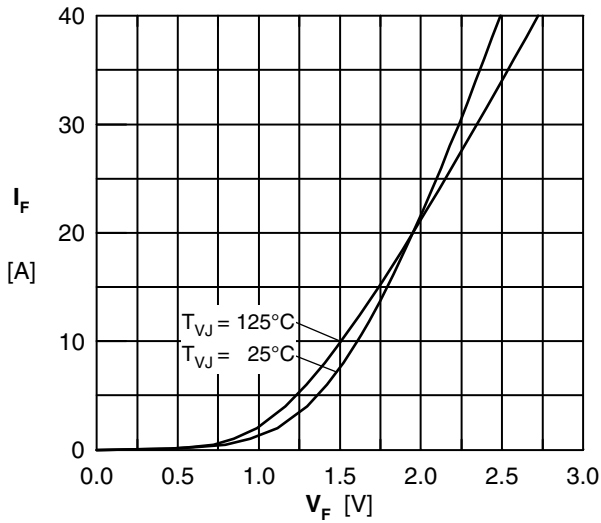

Fig. 7 Typ. Forward current versus V_F

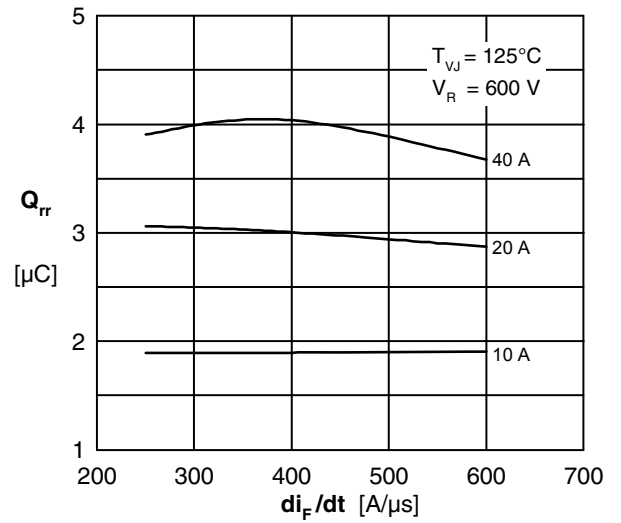

Fig. 8 Typ. reverse recov. charge Q_{rr} vs. di/dt

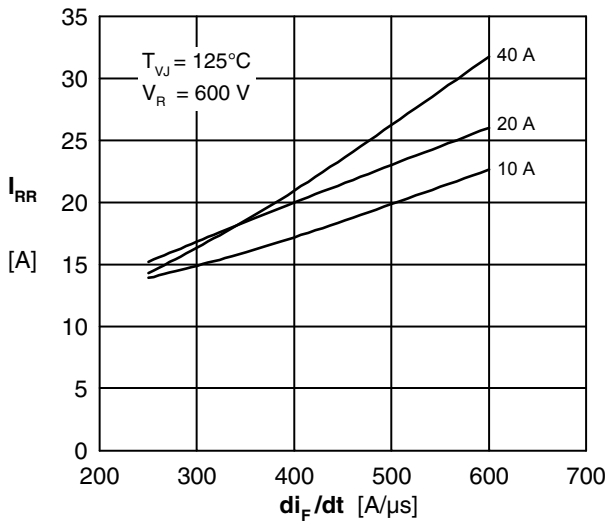

Fig. 9 Typ. peak reverse current I_{RM} vs. di/dt

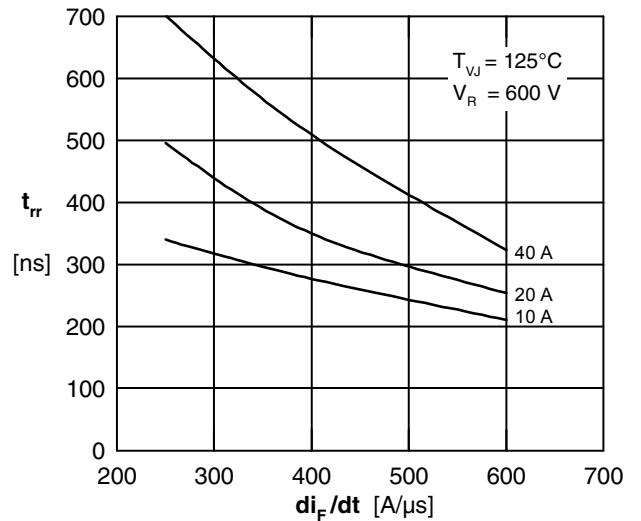

Fig. 10 Typ. recovery time t_{rr} versus di/dt

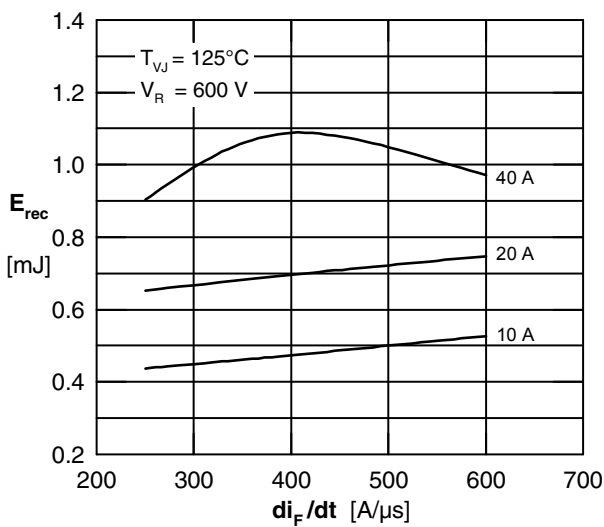

Fig. 11 Typ. recovery energy E_{rec} versus di/dt

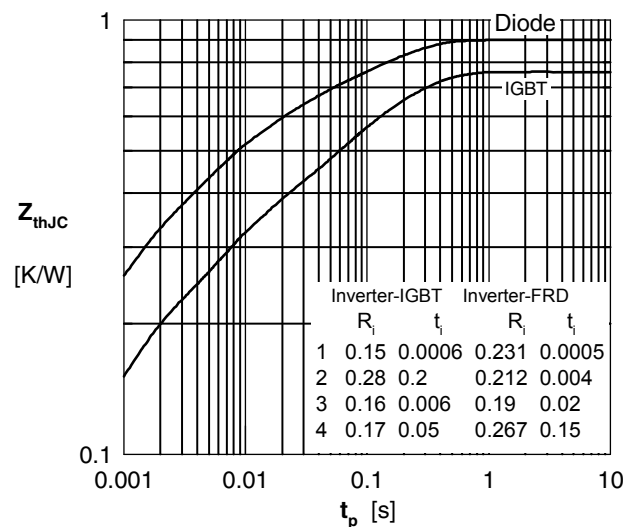

Fig. 12 Typ. transient thermal impedance



Disclaimer Notice - Information furnished is believed to be accurate and reliable. However, users should independently evaluate the suitability of and test each product selected for their own applications. Littelfuse products are not designed for, and may not be used in, all applications. Read complete Disclaimer Notice at www.littelfuse.com/disclaimer-electronics.