

Features

- 700 MHz - 6 GHz Low Noise Amplifier
- Low Noise Figure: 0.9 dB @ 5.8 GHz
- High Gain: 17.7 dB @ 5.8 GHz
- High Linearity OIP3: 34 dBm @ 5.5 GHz
- Single Voltage Bias: 3 - 5 V
- Integrated Active Bias Circuit
- Current Adjustable 30 - 80 mA
- Fast Switching Speed: <200 ns
- Lead-Free 2 mm 8-LD PDFN Package
- Halogen-Free "Green" Mold Compound
- RoHS* Compliant

Description

The MAAL-011134 is a high dynamic range, single stage MMIC LNA designed to operate from 700 MHz - 6 GHz assembled in a lead-free 2 mm 8-LD PDFN plastic package. This amplifier has ultra low noise figure, high gain and excellent linearity. In the 50 Ω environment and at 3 V, this device offers less than 0.5 dB noise figure at 2.4 GHz, with 24 dB of gain and over 33 dBm OIP3.

This low noise amplifier has an integrated active bias circuit allowing direct connection to 3 V or 5 V bias and minimizing variations over temperature and process. The bias current is set by an external resistor, so the user can customize the power consumption to fit the application. V_{BIAS} can be utilized as an enable pin to power the device up and down during operation.

This MAAL-011134 is ideally suited for 802.11 multimode applications at 2.4 GHz and 5.8 GHz. The high gain, low noise figure and fast switching speed make it ideal for 4 x 4 MIMO 802.11ac applications.

Ordering Information^{1,2}

Part Number	Package
MAAL-011134-TR3000	3000 piece reel
MAAL-011134-1SMB	Sample Board 5 - 6 GHz
MAAL-011134-2SMB	Sample Board 2.4 GHz

1. Reference Application Note M513 for reel size information.
2. All sample boards include 5 loose parts.

Functional Block Diagram

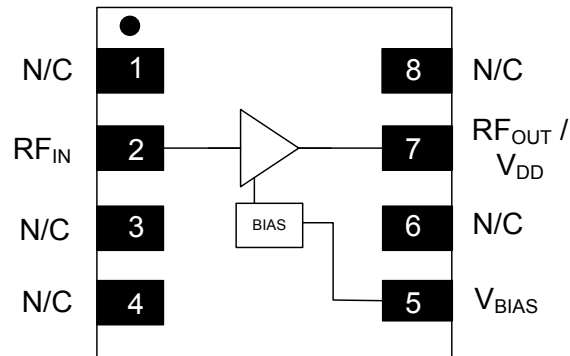

Pin Configuration³

Pin No.	Pin Name	Description
1	N/C	No Connection
2	RF _{IN}	RF Input
3	N/C	No Connection
4	N/C	No Connection
5	V _{BIAS}	Bias Voltage
6	N/C	No Connection
7	RF _{OUT} / V _{DD}	RF Output / Drain Voltage
8	N/C	No Connection
9	Pad ⁴	Ground

3. MACOM recommends connecting all No Connection (N/C) pins to ground.
4. The exposed pad centered on the package bottom must be connected to RF, DC and thermal ground.

*Restrictions on Hazardous Substances,
European Union Directive 2011/65/EU.

Electrical Specifications: Freq = 5.8 GHz, $V_{DD} = 3\text{ V}$, $+25^{\circ}\text{C}$, $Z_0 = 50\ \Omega$, $V_{BIAS} = 2.3\text{ V}^5$

Parameter	Test Conditions	Units	Min.	Typ.	Max.
Noise Figure	—	dB	—	0.85	1.30
Gain ⁶	—	dB	13	15	—
Input Return Loss ⁶	—	dB	—	7	—
Output Return Loss ⁶	—	dB	—	5.5	—
Output IP3 ⁶	$P_{IN} = -22\text{ dBm}$ per tone, 11 MHz spacing	dBm	—	28	—
Output P1dB	—	dBm	—	15	—
Current	I_{DD} I_{BIAS}	mA	—	60 1.5	80 —

5. Refer to biasing options.

6. Performance can be optimized using the 5 - 6 GHz circuit provided in the applications section.

Absolute Maximum Ratings^{7,8,9}

Parameter	Absolute Maximum
RF Input Power CW	18 dBm
V_{DD}	6 V
V_{BIAS}	5 V
Storage Temperature	-55°C to $+150^{\circ}\text{C}$
Operating Temperature	-40°C to $+105^{\circ}\text{C}$
Junction Temperature ¹⁰	$+150^{\circ}\text{C}$

7. Exceeding any one or combination of these limits may cause permanent damage to this device.
8. MACOM does not recommend sustained operation near these survivability limits.
9. Operating at nominal conditions with $T_J \leq 150^{\circ}\text{C}$ will ensure $MTTF > 1 \times 10^6$ hours.
10. Junction Temperature (T_J) = $T_C + \Theta_{JC} * ((V * I) - (P_{OUT} - P_{IN}))$
Typical thermal resistance (Θ_{JC}) = 83°C/W
 - a) For $T_C = +25^{\circ}\text{C}$,
 $T_J = 37^{\circ}\text{C}$ @ 3 V, 0.06 A, $P_{OUT} = 15\text{ dBm}$, $P_{IN} = 1\text{ dBm}$
 - b) For $T_C = +85^{\circ}\text{C}$,
 $T_J = 97^{\circ}\text{C}$ @ 3 V, 0.06 A, $P_{OUT} = 15\text{ dBm}$, $P_{IN} = 1\text{ dBm}$

Handling Procedures

Please observe the following precautions to avoid damage:

Static Sensitivity

Gallium Arsenide Integrated Circuits are sensitive to electrostatic discharge (ESD) and can be damaged by static electricity. Proper ESD control techniques should be used when handling these devices.

Biasing Options

The MAAL-011134 bias can be set in 2 different ways: using only V_{DD} or using separate V_{DD} and V_{BIAS} voltages. A separate V_{BIAS} voltage allows pin 5 (V_{BIAS}) to be used as an enable pin to power the device up and down during operation.

For both bias methods select the value of R_{BIAS} to achieve the desired current based on the tables on page 4, and use DC blocks at pin 2 (RF_{IN}) and pin 7 (RF_{OUT} / V_{DD}).

Biasing Option - V_{DD} only

To use only V_{DD} , connect pin 7 (RF_{OUT} / V_{DD}) to V_{DD} through an RF choke inductor and connect pin 5 (V_{BIAS}) to V_{DD} through bias resistor R_{BIAS} as shown in Figure 1.

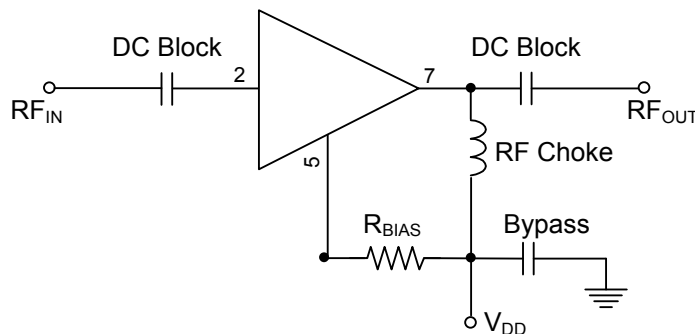

Figure 1

Biasing Option - Separate V_{DD} and V_{BIAS} Voltages ($V_{BIAS} \leq V_{DD}$)

To use separate V_{DD} and V_{BIAS} voltages, connect pin 7 (RF_{OUT} / V_{DD}) to V_{DD} through an RF choke inductor and connect pin 5 (V_{BIAS}) to V_{BIAS} through bias resistor R_{BIAS} as shown in Figure 2. Typical current (I_{BIAS}) draw for pin 5 (V_{BIAS}) is 1.4 mA @ $V_{BIAS} = 3$ V and 1 μ A @ $V_{BIAS} = 0$ V. Typical current (I_{DD}) draw for pin 7 (RF_{OUT} / V_{DD}) is < 1 μ A @ $V_{BIAS} = 0$ V.

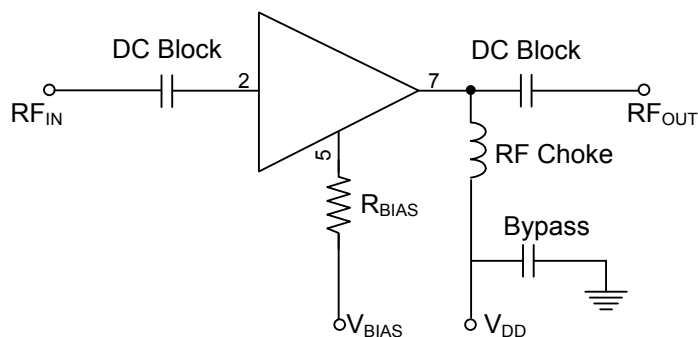
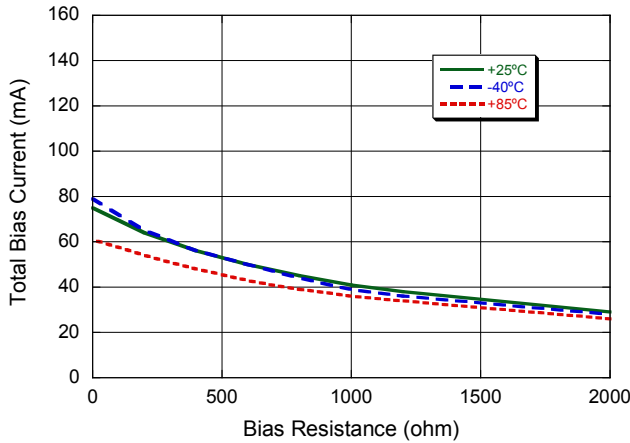

Figure 2

Typical Performance Curves of the Active Bias Circuit

Current, $V_{DD} = 3 V$



Current, $V_{DD} = 4 V$

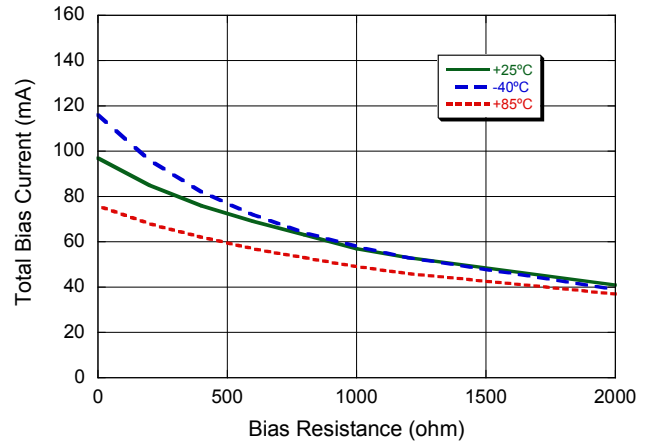

Current, $V_{DD} = 5 V$

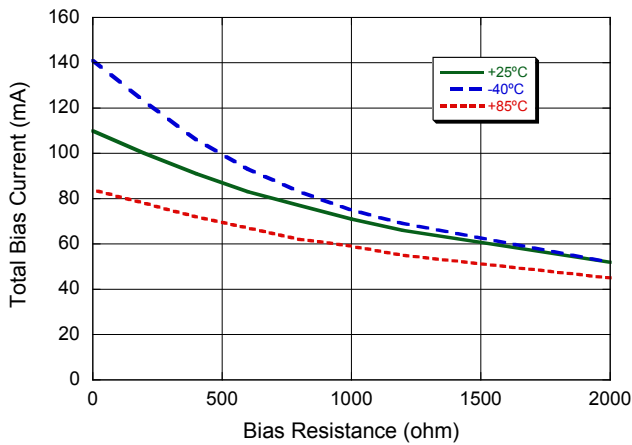

Bias Table

Bias Resistance (Ω)	Total Current (mA)								
	$V_{DD} = 3 V$			$V_{DD} = 4 V$			$V_{DD} = 5 V$		
	+25°C	-40°C	+85°C	+25°C	-40°C	+85°C	+25°C	-40°C	+85°C
2000	29	28	26	41	39	37	52	52	45
1200	38	36	34	53	53	46	66	69	55
1000	41	39	36	57	58	49	71	75	59
800	45	44	39	63	64	53	77	83	62
600	50	50	43	69	72	57	83	93	67
400	56	56	48	76	82	62	91	106	72
200	64	65	54	85	96	68	100	123	78
0	75	79	61	97	116	76	110	141	84

4

MACOM Technology Solutions Inc. (MACOM) and its affiliates reserve the right to make changes to the product(s) or information contained herein without notice. Visit www.macom.com for additional data sheets and product information.

Low Noise Amplifier 700 MHz - 6 GHz

Rev. V6

Typical Performance Curves @ 3 V / 60 mA, $Z_0 = 50 \Omega$

Gain

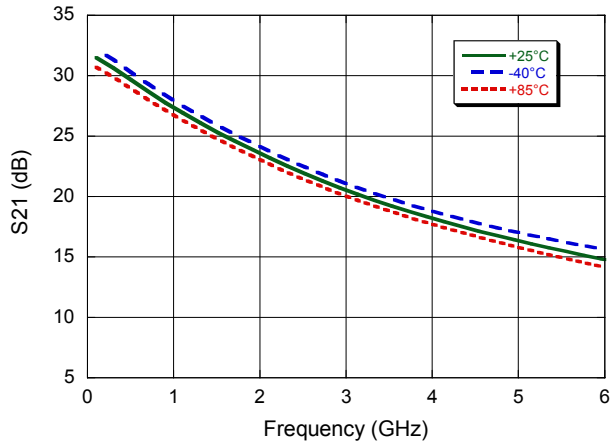

Noise Figure

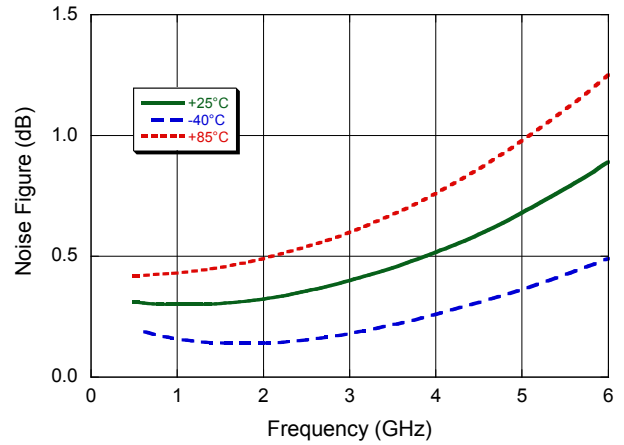

Input Return Loss

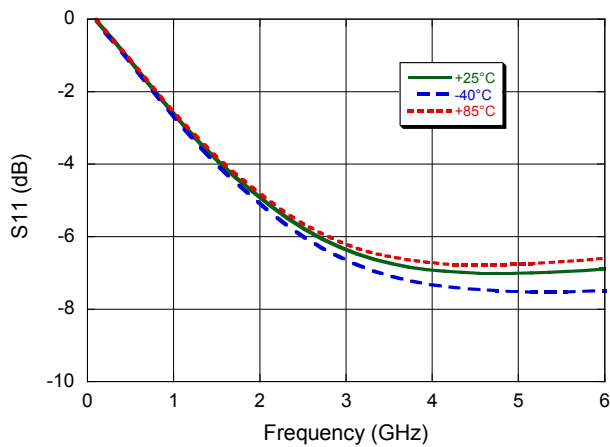

Output Return Loss

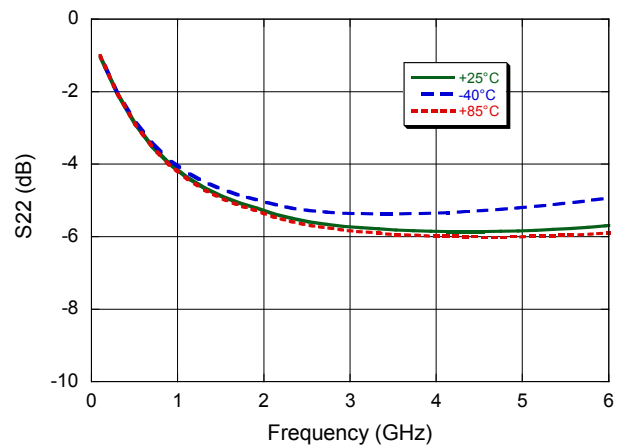

OIP3

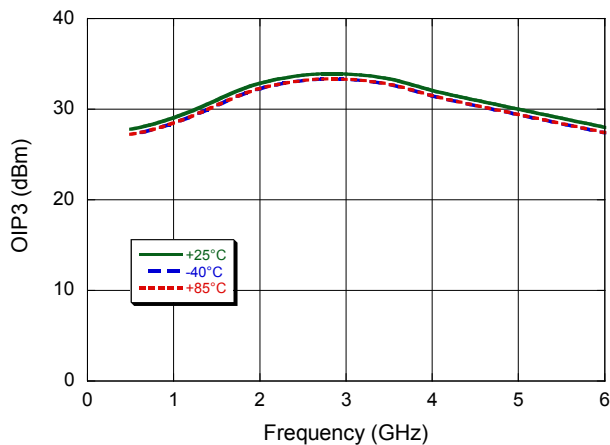

P1dB

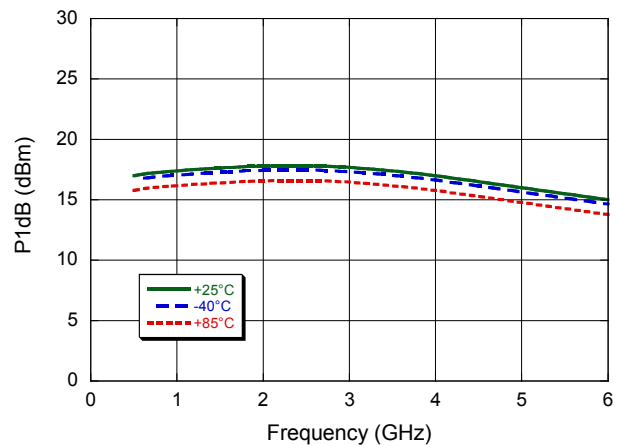

Low Noise Amplifier 700 MHz - 6 GHz

Rev. V6

Typical Performance Curves @ 5 V / 70 mA, $Z_0 = 50 \Omega$

Gain

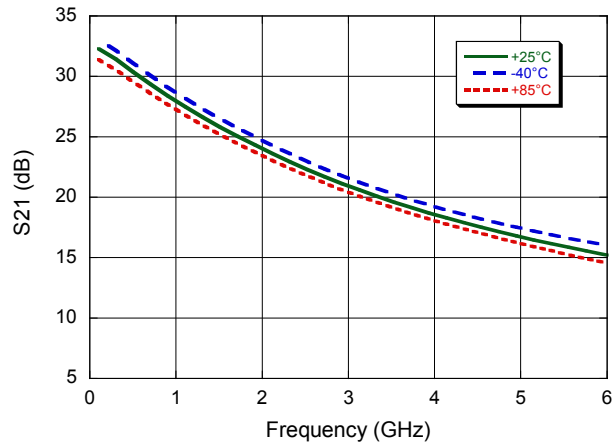

Noise Figure

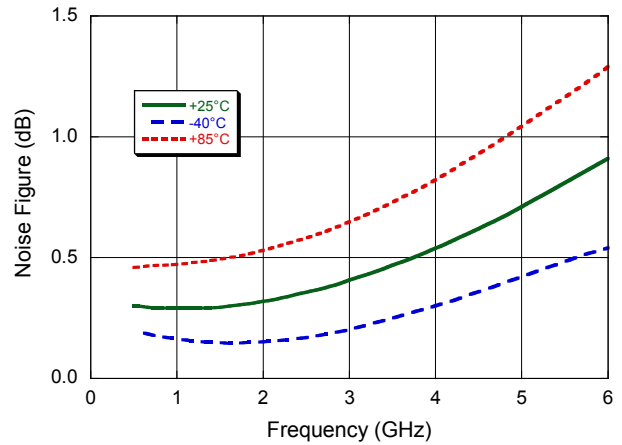

Input Return Loss

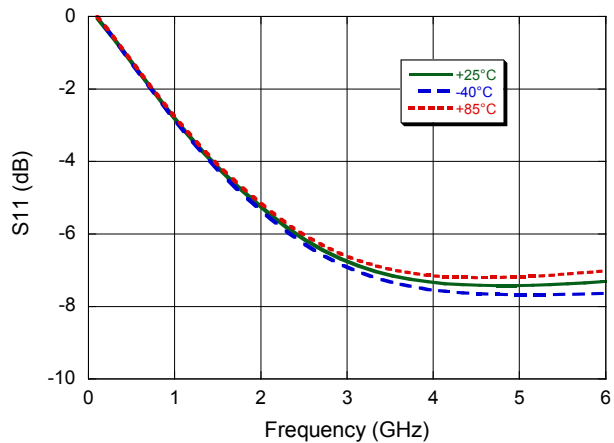

Output Return Loss

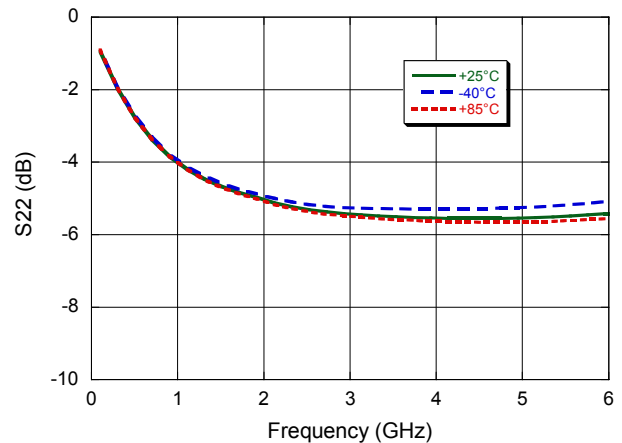

OIP3

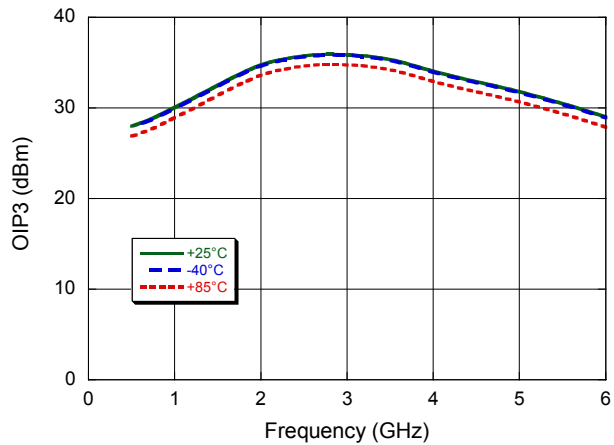

P1dB

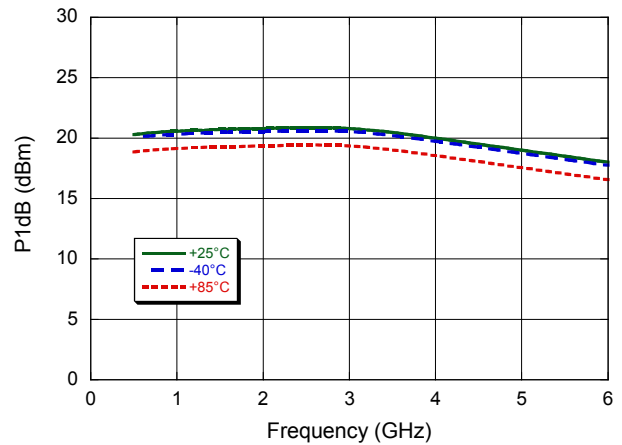

Low Noise Amplifier 700 MHz - 6 GHz

Rev. V6

Typical Performance Curves @ 3 V / 30 mA, 3 V / 60 mA, 5 V / 70 mA, $Z_0 = 50 \Omega$

Gain

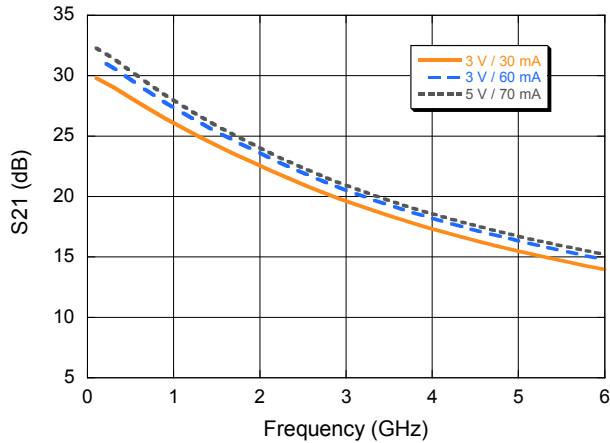

Noise Figure

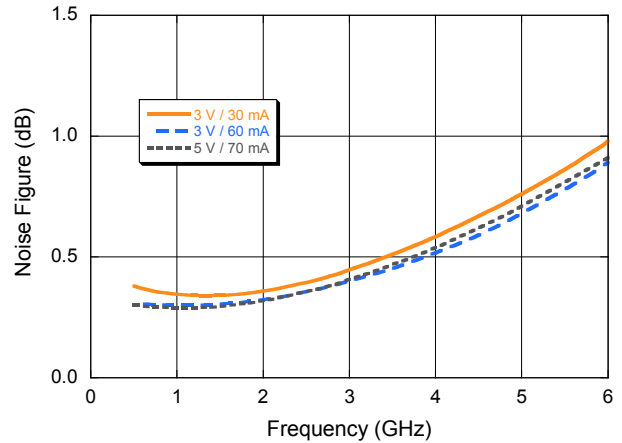

Input Return Loss

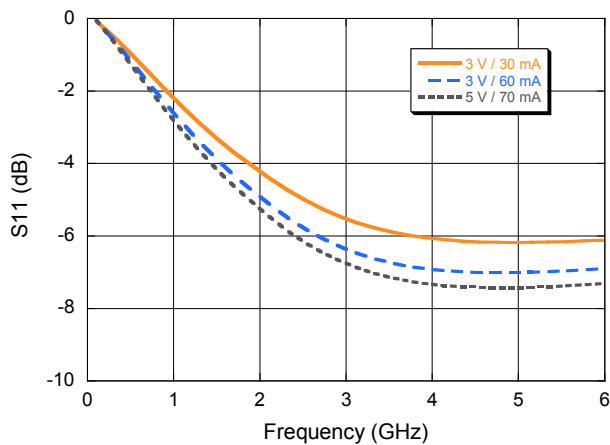

Output Return Loss

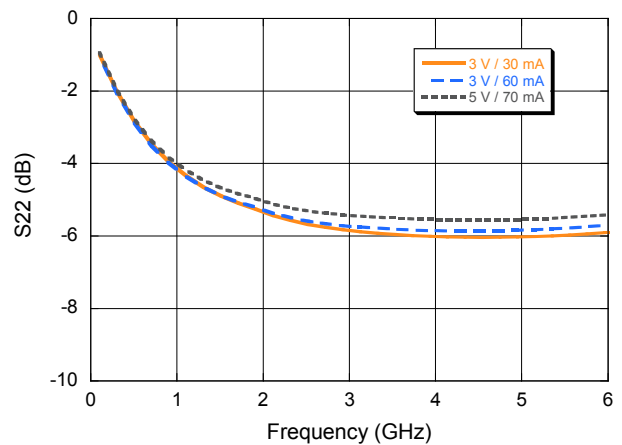

OIP3

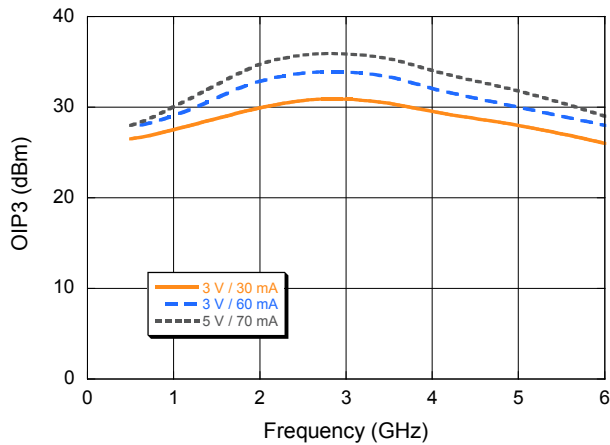

P1dB

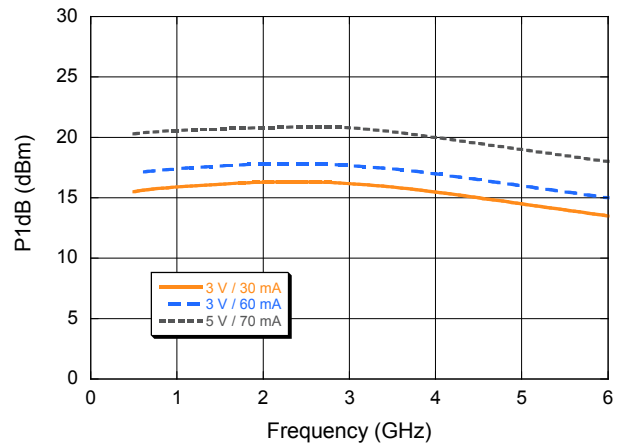

Lead-Free 2 mm 8-Lead PDFN[†]

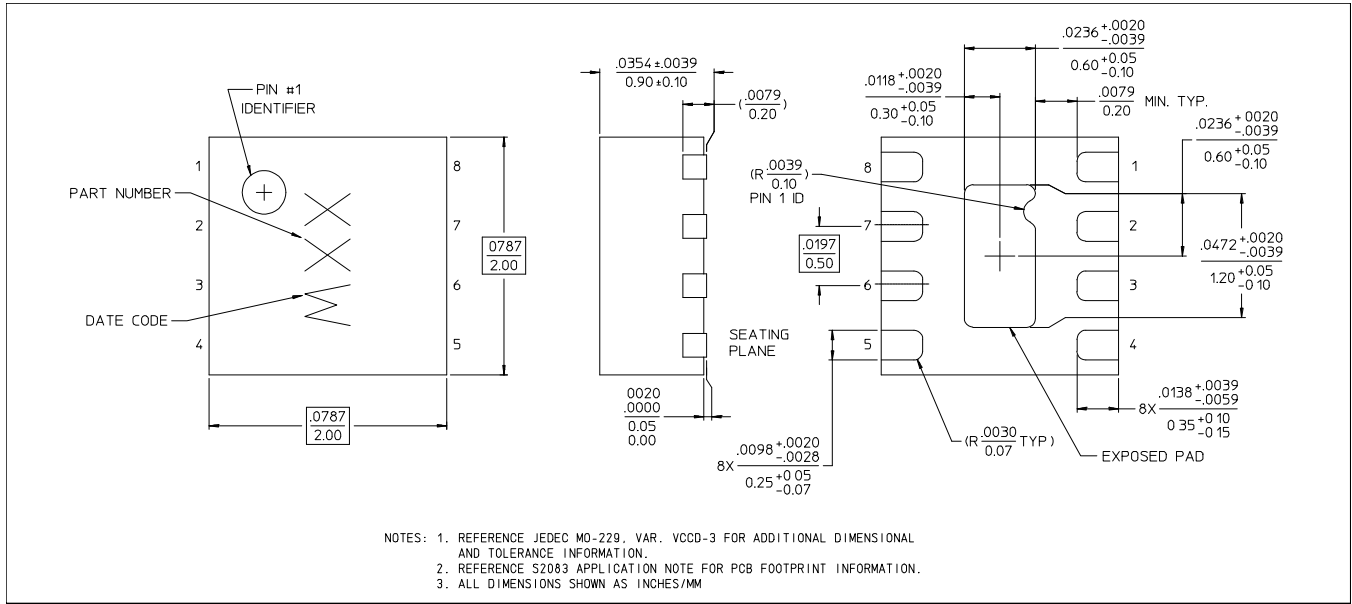

[†] Reference Application Note S2083 for lead-free solder reflow recommendations.
Meets JEDEC moisture sensitivity level 1 requirements.
Plating is 100% matte tin over copper.

Applications Section 1: 5 - 6 GHz

The MAAL-011134 is designed to work as a low noise gain block over a wide range of frequencies in a 50 Ω environment.

Input and output can be tuned to improve performance over a specific frequency band.

The evaluation board shown has been designed for tuning flexibility. The parts list on page 10 details the components needed to tune the MAAL-011134 for operation from 5 - 6 GHz. R1 or R2 may be used as R_{BIAS} according to the biasing option chosen.

Evaluation Board, 5 - 6 GHz¹¹

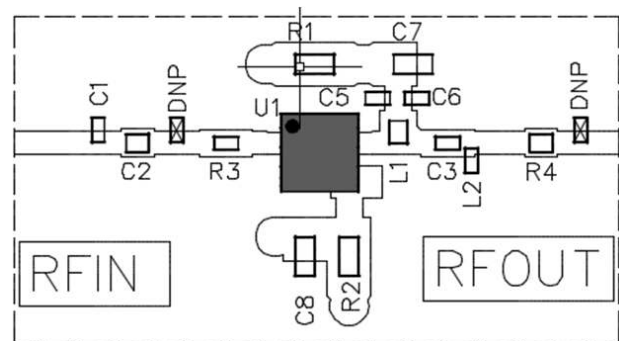
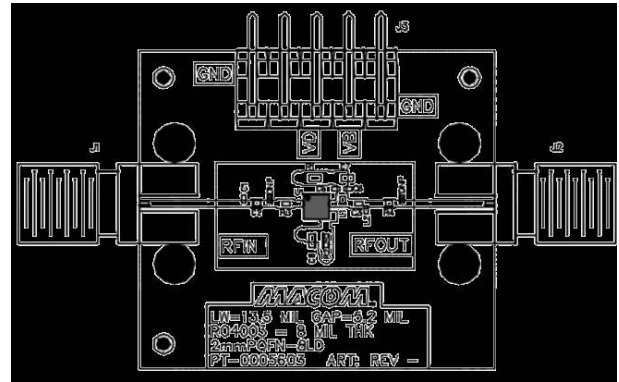

11. MACOM recommends placing components exactly as shown in the Evaluation Board, 5 - 6 GHz drawing.

Schematic, 5 - 6 GHz

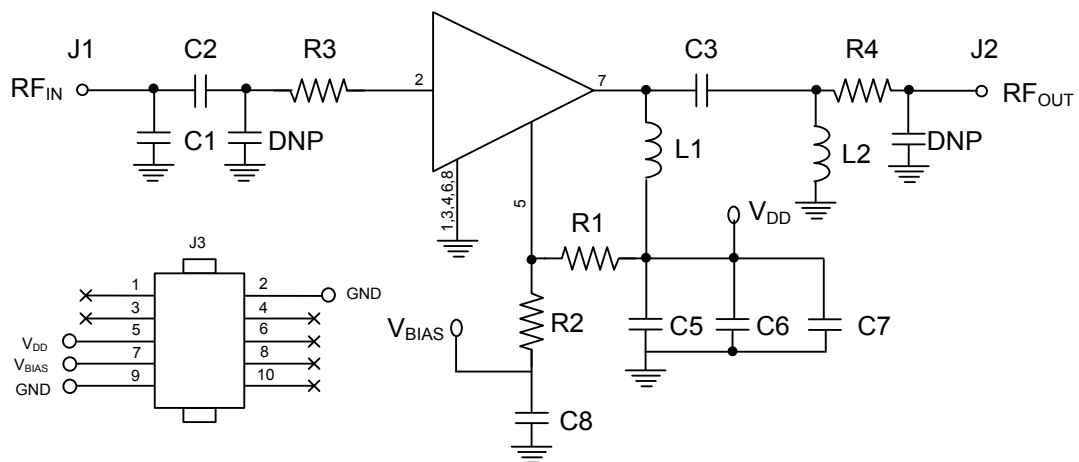

Applications Section 1: 5 - 6 GHz

Parts List, 5 - 6 GHz

Component	Value	Size	Manufacturer
C1	0.3 pF	0201	Johansson Technology 250R05L0R3BV4S
C2	1.8 pF	0201	Johansson Technology 250R05L1R8BV4S
C3	15 pF	0201	Johansson Technology 250R05L150JV4S
C6	47 pF	0201	Murata GRM0335C1E470JA01
C5	1000 pF	0201	Murata GRM033R71E102KA01D
C7, C8	0.1 μ F	0402	Murata GRM155R71C104K
L1	1.2 nH	0201	Johansson Technology L-05C1N2SV4S
L2	2.7 nH	0201	Johansson Technology L-05C2N7SV4S
R1, R2 ¹²	470 Ω	0402	YAGEO RC0402FR-07470RL
R3, R4	0 Ω	0201	Bourns Electronics CR0201-J/-000GLF

12. Use R1 or R2 as R_{BIAS} according to the biasing option chosen (see biasing options on page 3).

Electrical Specifications¹³: Freq. = 5.5 GHz, T_A = +25°C

Parameter	Test Conditions	Units	Min.	Typ.	Max.
Noise Figure	—	dB	—	1.1	—
Gain	—	dB	—	17.4	—
Input Return Loss	—	dB	—	13	—
Output Return Loss	—	dB	—	10	—
Output IP3	P _{IN} = -22 dBm per tone, 11 MHz spacing	dBm	—	34	—
Current	I _{DD} + I _{BIAS}	mA	—	50	—
Voltage	—	V	—	3 to 5	—

13. Typical performance, including board and connector losses, of the evaluation board with components shown in the 5 - 6 GHz parts list.

Applications Section 1: 5 - 6 GHz

Typical Performance Curves @ 3 V, 5 - 6 GHz Applications Circuit

Gain

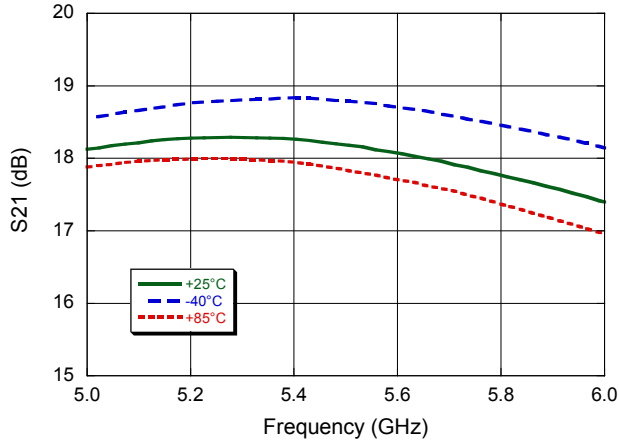

Reverse Isolation

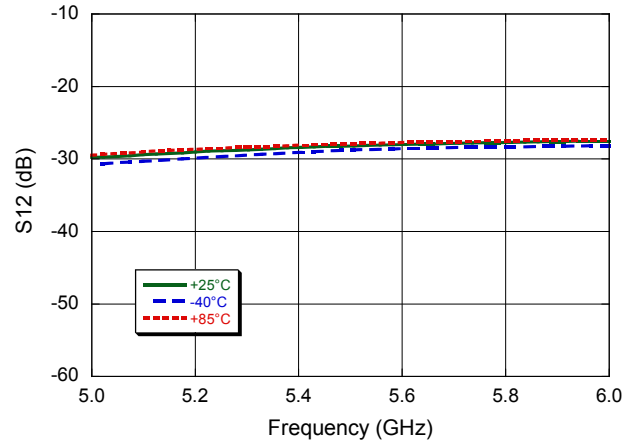

Input Return Loss

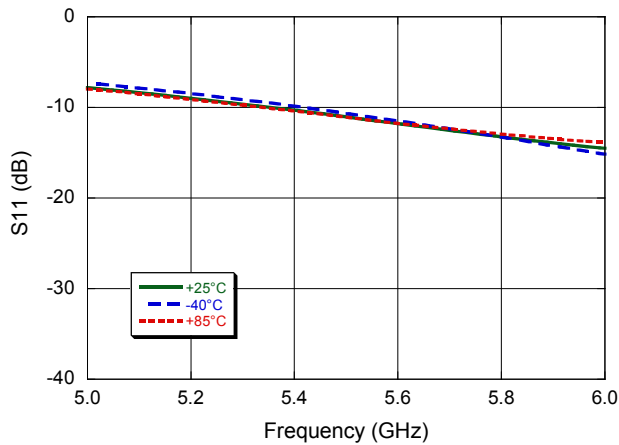

Output Return Loss

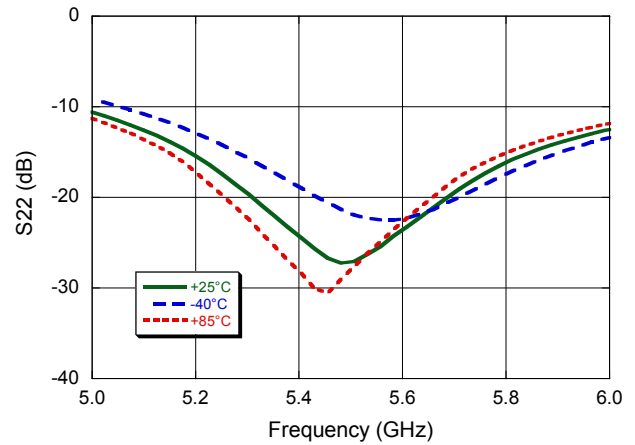

Noise Figure @ +25°C

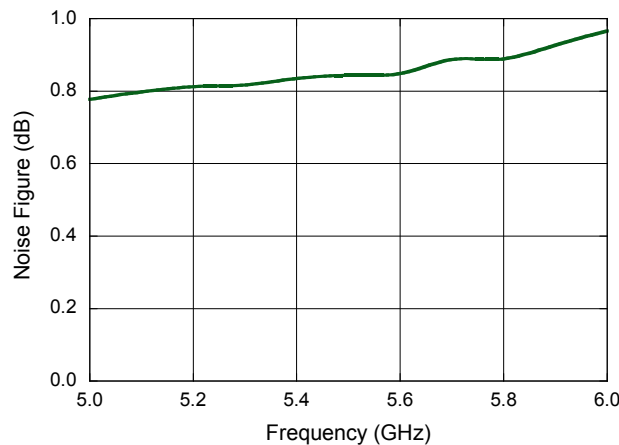

Output IP3 @ 5.5 GHz over bias

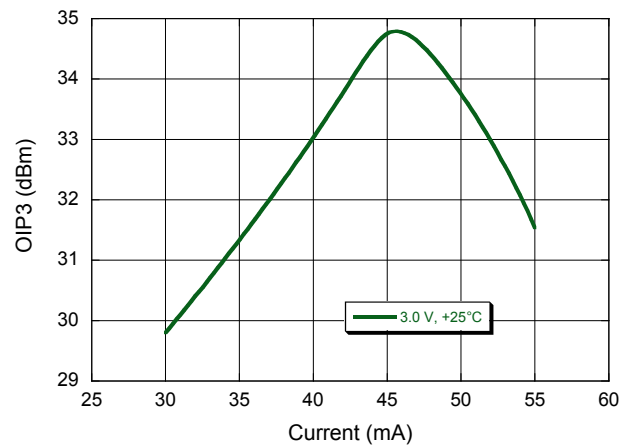

2.3 - 2.7 GHz Application Section

The MAAL-011134 is designed to work as a low noise gain block over a wide range of frequencies in a 50 Ω environment.

Input and output can be tuned to improve return loss over a specific frequency band.

The evaluation board shown has been designed for tuning flexibility. The parts list on page 16 details the components needed to tune the MAAL-011134 for operation from 2.3 - 2.7 GHz. R1 or R2 may be used as R_{BIAS} according to the biasing option chosen.

Evaluation Board, 2.3 - 2.7 GHz

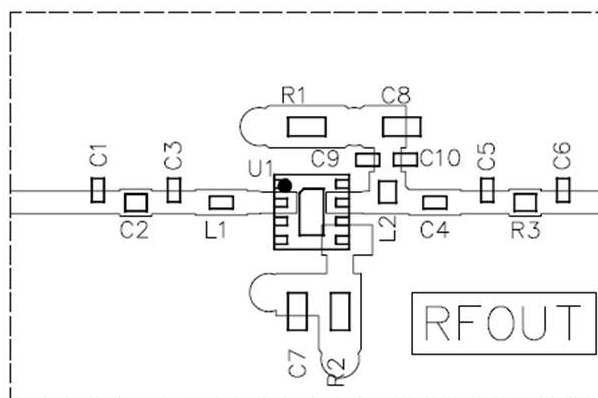
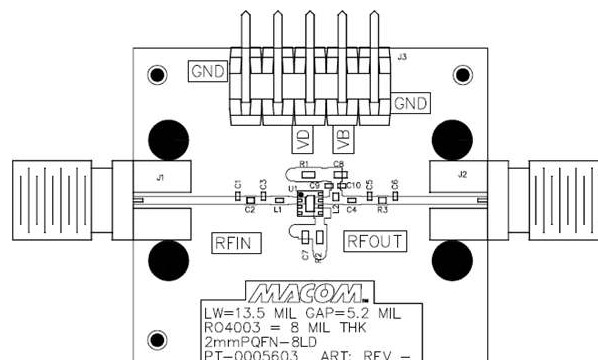

Schematic, 2.3 - 2.7 GHz

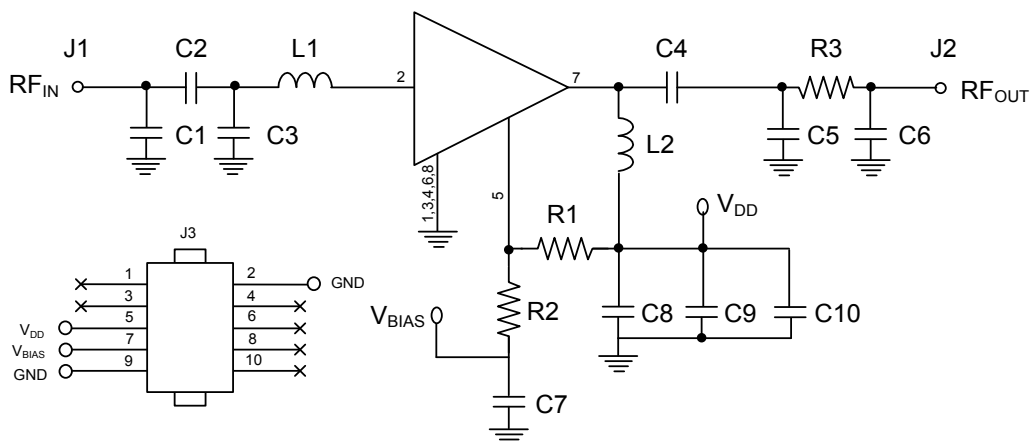

2.3 - 2.7 GHz Application Section

Parts List, 2.3 - 2.7 GHz

Component	Value	Size	Manufacturer	Manufacturer Part #
C1	—	0201	—	—
C2	10 pF	0201	Murata	GJM0336C1E100JB01
C3	0.7 pF	0201	Murata	GJM0335C1ER70WB0
C4	1.8 pF	0201	Murata	GJM0335C1E1R8BB01
C5	0.4 pF	0201	Murata	GJM0335C1ER40WB01
C6	—	0201	—	—
C7	—	0402	—	—
C8	0.1 μ F	0402	—	—
C9, C10	49 pF	0201	—	—
L1	2.5 nH	0201	Coilcraft	0201DS-2N5XJL
L2	2.7 nH	0201	Murata	LQP03TN2N7C02
R1	470 Ω	0402	—	—
R2	—	0402	—	—
R3	0 Ω	0201	—	—

Low Noise Amplifier 700 MHz - 6 GHz

Rev. V6

Electrical Specifications: Freq = 2.6 GHz^{14,15}, V_{DD} = 3 V, +25°C, Z₀ = 50 Ω

Parameter	Test Conditions	Units	Min.	Typ.	Max.
Noise Figure	-	dB	—	0.7	—
Gain	-	dB	—	23	—
Input Return Loss	-	dB	—	16	—
Output Return Loss	-	dB	—	10	—
Output IP3	P _{IN} = -22 dBm, tones 11 MHz apart	dBm	—	33.4	—
Total Current	I _{DQ} = I _{DD} + I _{BIAS}	mA	—	50	—

14. Typical performance of the evaluation module with exact components shown on the 2.3 - 2.7 GHz parts list.

15. Typical measured data includes evaluation board and connector losses.

Typical Performance Curves: Broadband performance (2.3 - 2.7 GHz evaluation board)

Gain

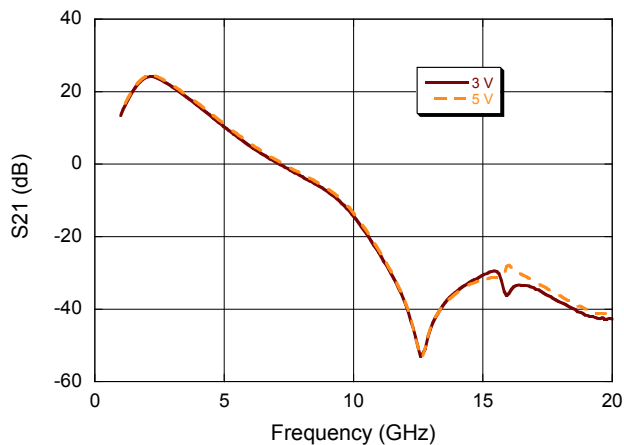

Reverse Isolation

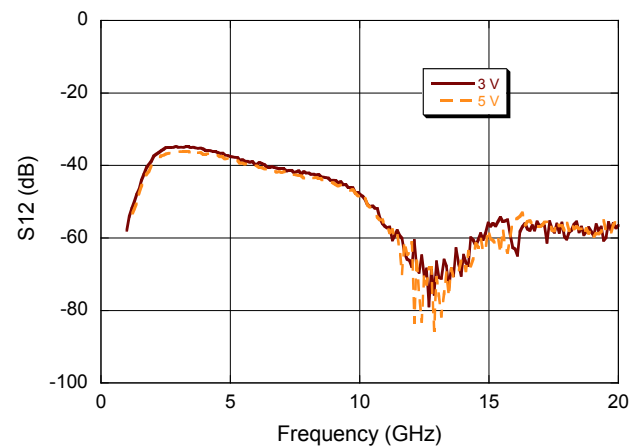

Input Return Loss

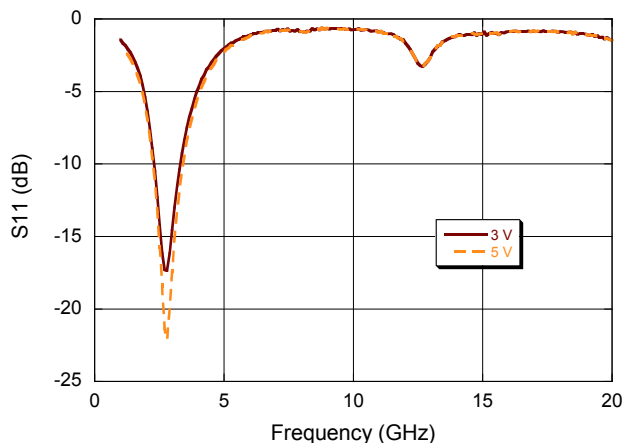

Output Return Loss

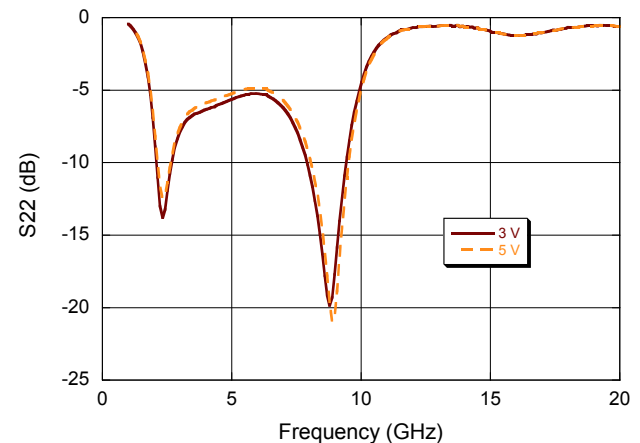

Low Noise Amplifier 700 MHz - 6 GHz

Rev. V6

Typical Performance Curves: Freq = 2.3 - 2.7 GHz, $Z_0 = 50 \Omega$

Gain

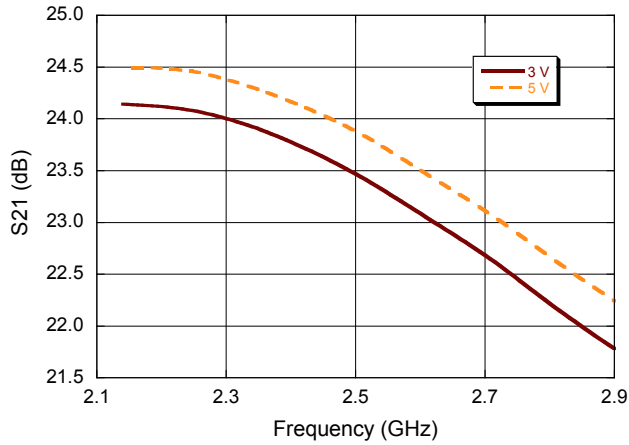

Noise Figure

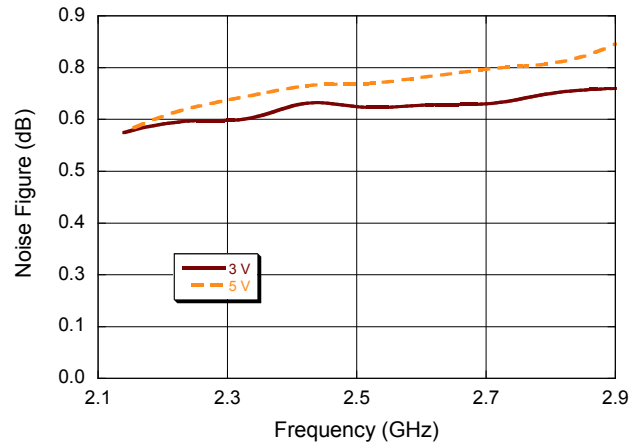

Input Return Loss

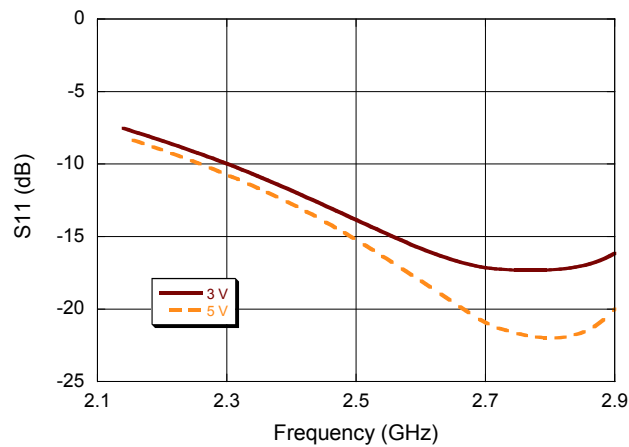

Output Return Loss

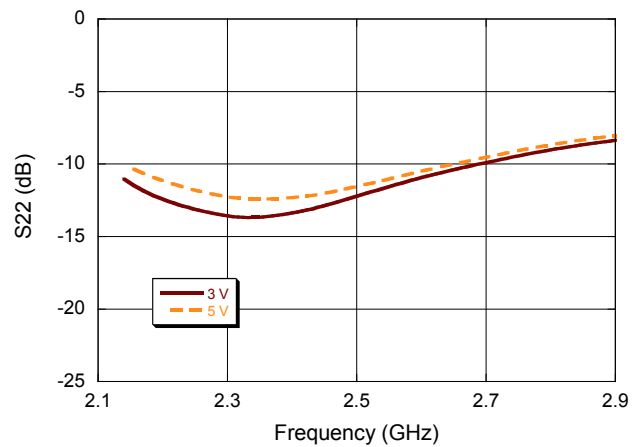

Reverse Isolation

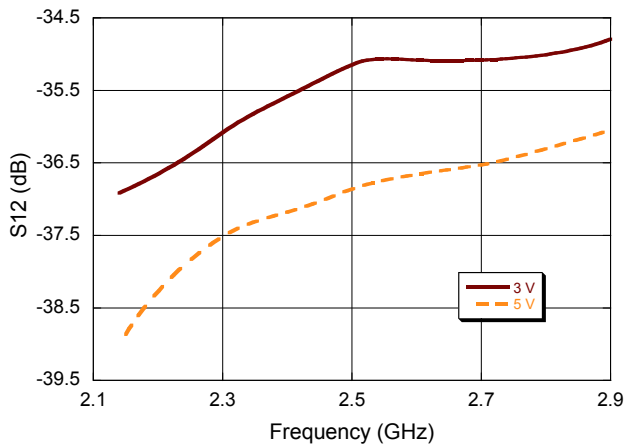

OIP3

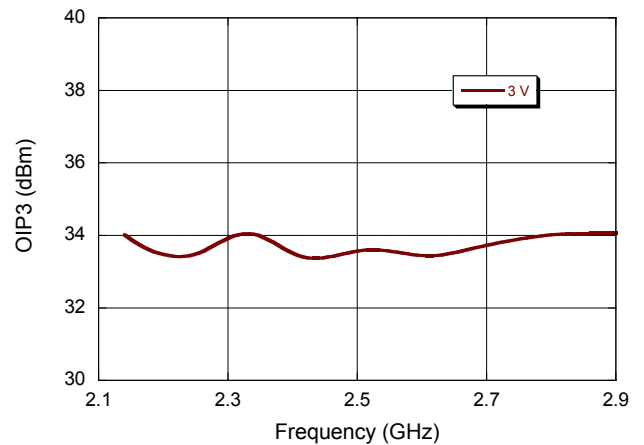

1.88 - 2.025 GHz Application Section

The MAAL-011134 is designed to work as a low noise gain block over a wide range of frequencies in a 50 Ω environment.

Input and output can be tuned to improve return loss over a specific frequency band.

The evaluation board shown has been designed for tuning flexibility. The parts list on page 16 details the components needed to tune the MAAL-011134 for operation from 1.88 - 2.025 GHz. R1 or R2 may be used as R_{BIAS} according to the biasing option chosen.

Evaluation Board, 1.88 - 2.025 GHz

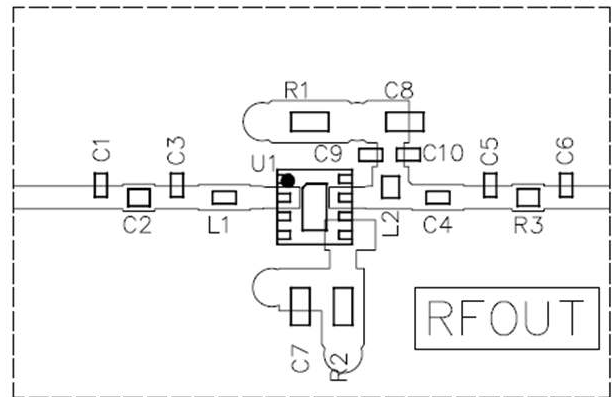
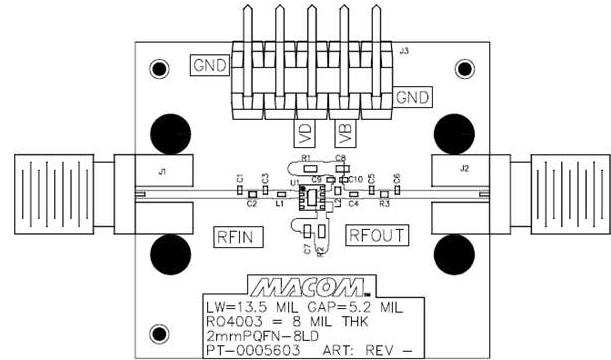

Schematic, 1.88 - 2.025 GHz

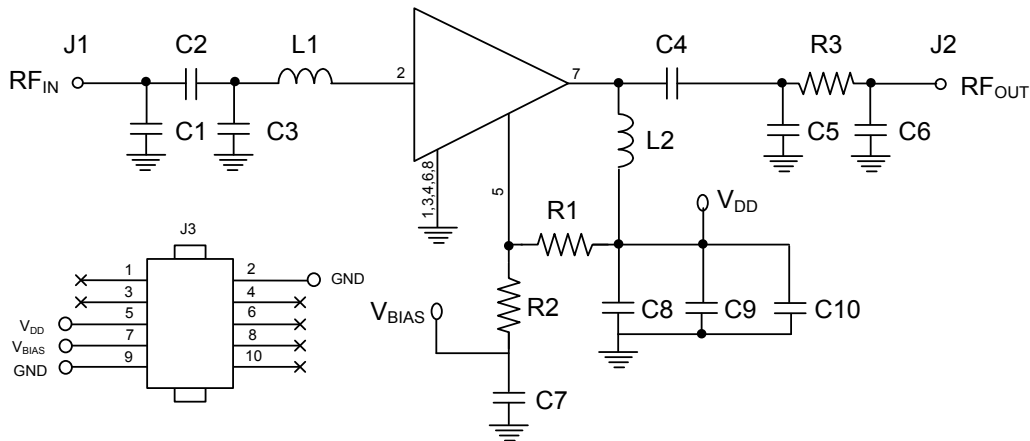

1.88 - 2.025 GHz Application Section

Parts List: 1.88 - 2.025 GHz

Component	Value	Size	Manufacturer	Manufacturer Part #
C1	—	0201	—	—
C2	10 pF	0201	Murata	GJM0336C1E100JB01
C3	1.8 pF	0201	Murata	GJM0335C1E1R8BB01
C4	2.2 pF	0201	Murata	GJM0335C1E2R2BB01
C5	1.2 pF	0201	Murata	GJM0335C1E1R2BB01
C6	—	0201	—	—
C7	—	0402	—	—
C8	0.1 μ F	0402	—	—
C9, C10	49 pF	0201	—	—
L1	4.7 nH	0201	Coilcraft	0201DS-4N7XJL
L2	2.7 nH	0201	Murata	LQP03TN2N7C02
R1	470 Ω	0402	—	—
R2	—	0402	—	—
R3	0 Ω	0201	—	—

Low Noise Amplifier 700 MHz - 6 GHz

Rev. V6

Electrical Specifications: Freq = 2.6 GHz^{16,17}, $V_{DD} = 3\text{ V}$, +25°C, $Z_0 = 50\ \Omega$

Parameter	Test Conditions	Units	Min.	Typ.	Max.
Noise Figure	-	dB	—	0.7	—
Gain	-	dB	—	25.5	—
Input Return Loss	-	dB	—	15	—
Output Return Loss	-	dB	—	15	—
Total Current	$I_{DQ} = I_{DD} + I_{BIAS}$	mA	—	50	—

16. Typical performance of the evaluation module with exact components shown on the 1.88 - 2.025 GHz parts list.

17. Typical measured data includes evaluation board and connector losses.

Typical Performance Curves @ 3 V: 1.88 - 2.025 GHz evaluation board)

Gain

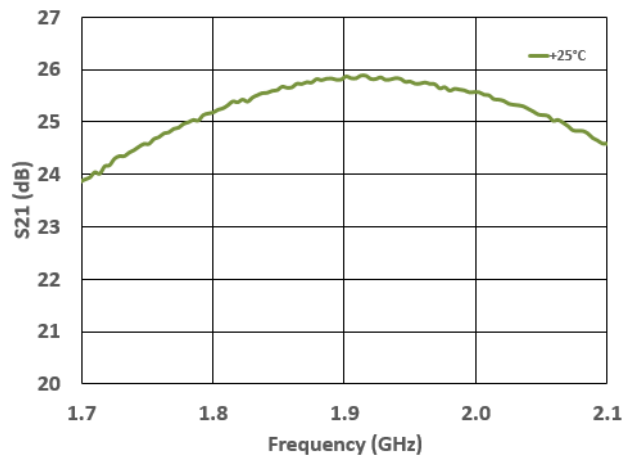

Reverse Isolation

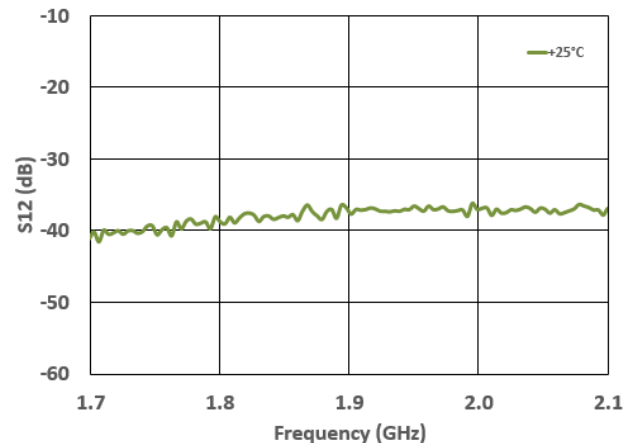

Input Return Loss

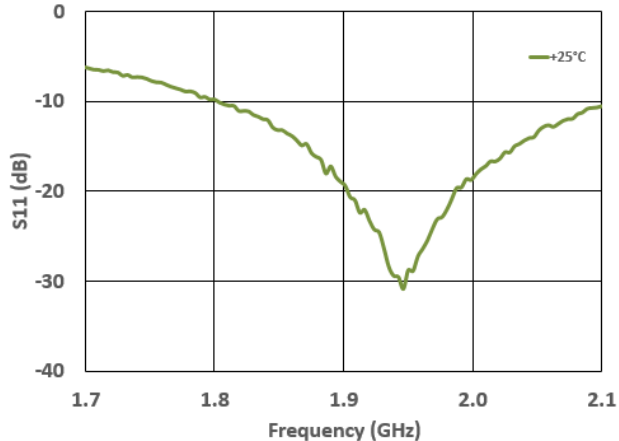

Output Return Loss

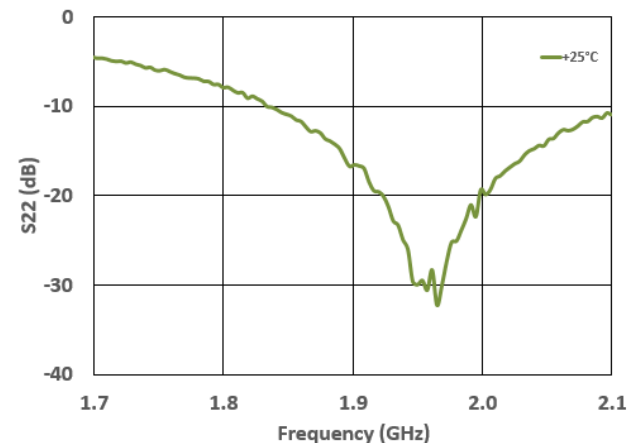

MACOM Technology Solutions Inc. All rights reserved.

Information in this document is provided in connection with MACOM Technology Solutions Inc ("MACOM") products. These materials are provided by MACOM as a service to its customers and may be used for informational purposes only. Except as provided in MACOM's Terms and Conditions of Sale for such products or in any separate agreement related to this document, MACOM assumes no liability whatsoever. MACOM assumes no responsibility for errors or omissions in these materials. MACOM may make changes to specifications and product descriptions at any time, without notice. MACOM makes no commitment to update the information and shall have no responsibility whatsoever for conflicts or incompatibilities arising from future changes to its specifications and product descriptions. No license, express or implied, by estoppel or otherwise, to any intellectual property rights is granted by this document.

THESE MATERIALS ARE PROVIDED "AS IS" WITHOUT WARRANTY OF ANY KIND, EITHER EXPRESS OR IMPLIED, RELATING TO SALE AND/OR USE OF MACOM PRODUCTS INCLUDING LIABILITY OR WARRANTIES RELATING TO FITNESS FOR A PARTICULAR PURPOSE, CONSEQUENTIAL OR INCIDENTAL DAMAGES, MERCHANTABILITY, OR INFRINGEMENT OF ANY PATENT, COPYRIGHT OR OTHER INTELLECTUAL PROPERTY RIGHT. MACOM FURTHER DOES NOT WARRANT THE ACCURACY OR COMPLETENESS OF THE INFORMATION, TEXT, GRAPHICS OR OTHER ITEMS CONTAINED WITHIN THESE MATERIALS. MACOM SHALL NOT BE LIABLE FOR ANY SPECIAL, INDIRECT, INCIDENTAL, OR CONSEQUENTIAL DAMAGES, INCLUDING WITHOUT LIMITATION, LOST REVENUES OR LOST PROFITS, WHICH MAY RESULT FROM THE USE OF THESE MATERIALS.

MACOM products are not intended for use in medical, lifesaving or life sustaining applications. MACOM customers using or selling MACOM products for use in such applications do so at their own risk and agree to fully indemnify MACOM for any damages resulting from such improper use or sale.