

EBM7LR400 Datasheet

Technical Specifications

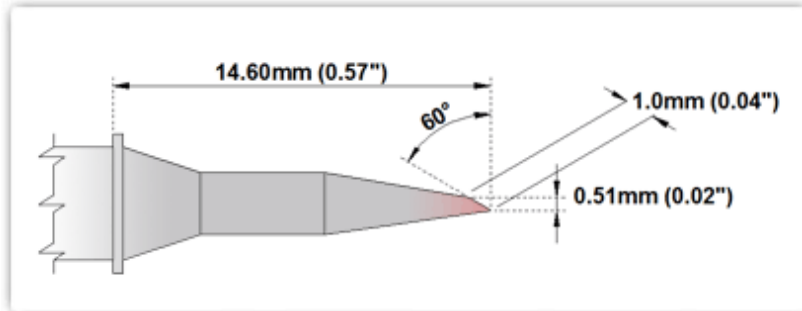

EBM7LR400

Long Reach Bevel 60° 1.0mm (0.04")

Tip Style: Long Reach Bevel 60°

Tip Width: 1.00mm (0.04")

Tip Length: 14.60mm (0.57")

700°F Type Cartridge¹:

RoHS Compliant² / Lead Free:

Equivalent to:

For Use With:

350°C - 398°C

YES

STTC-146

EB-9000S

Material Composition

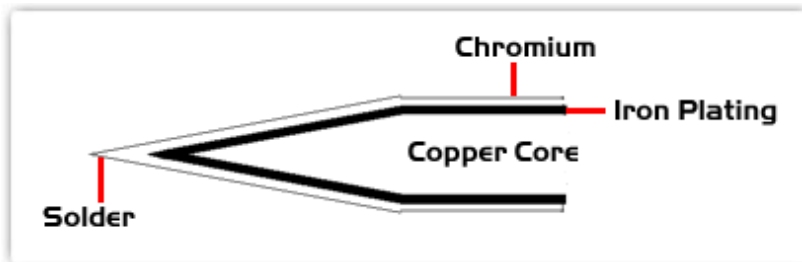

All components are RoHS compliant and Lead-Free.

¹ Easybraid tip cartridges will typically idle within a temperature range of +/-1.1°C. However, there is variation in idle temperature across tip geometries within an individual temperature series. Easybraid offers a wide variety of tip geometries from 0.4mm fine point tip to 5m chisel. The length and geometry of a tip will have an influence on the tip idle temperature. To accurately measure idle temperature it will depend greatly on the measurement method, technique and equipment used. Two different methods or the use of alternative equipment will produce different test results.

² Please refer to <http://www.rohs.gov.uk> for details on RoHS Compliance.