

NCV47822

Dual High Side Switch with Adjustable Current Limit and Diagnostic Features

The NCV47822 dual channel High Side Switch (HSS) with 250 mA per channel is designed for use in harsh automotive environments. The device has a high peak input voltage tolerance and reverse input voltage, reverse bias, overcurrent and overtemperature protections. The integrated current sense feature (adjustable by resistor connected to CSO pin for each channel) provides diagnosis and system protection functionality. The CSO pin output current creates voltage drop across CSO resistor which is proportional to output current of each channel. Extended diagnostic features in OFF state are also available and controlled by dedicated input and output pins.

Features

- Output Current per Channel: up to 250 mA
- Two Independent Enable Inputs (3.3 V Logic Compatible)
- Adjustable Current Limits: up to 350 mA
- Protection Features:
 - ◆ Current Limitation
 - ◆ Thermal Shutdown
 - ◆ Reverse Input Voltage and Reverse Bias Voltage
- Diagnostic Features:
 - ◆ Short To Battery (STB) and Open Load (OL) in OFF State
 - ◆ Internal Components for OFF State Diagnostics
 - ◆ Open Collector Flag Output
 - ◆ Two Output Voltage Monitoring Outputs (Analog)
- AEC-Q100 Grade 1 Qualified and PPAP Capable
- These Devices are Pb-Free, Halogen Free/BFR Free and are RoHS Compliant

Typical Applications

- Audio and Infotainment System
- Active Safety System

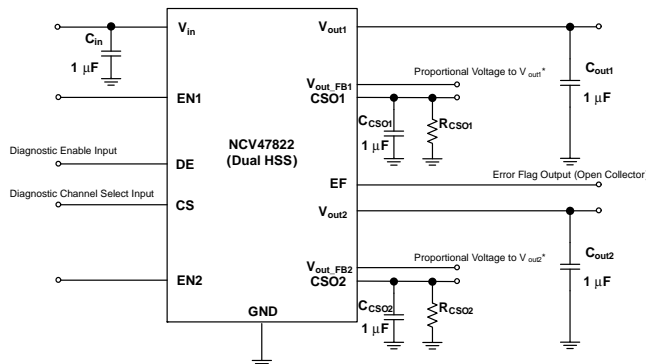

* V_{out_FB1} and V_{out_FB2} are sensed V_{out1} and V_{out2} output voltages, respectively, via internal resistor dividers

Figure 1. Application Schematic
(See Application Section for More Details)



ON Semiconductor®

www.onsemi.com

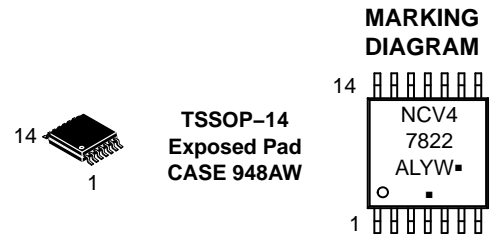

- A = Assembly Location
- L = Wafer Lot
- Y = Year
- W = Work Week
- = Pb-Free Package

(Note: Microdot may be in either location)

ORDERING INFORMATION

See detailed ordering and shipping information in the package dimensions section on page 13 of this data sheet.

NCV47822

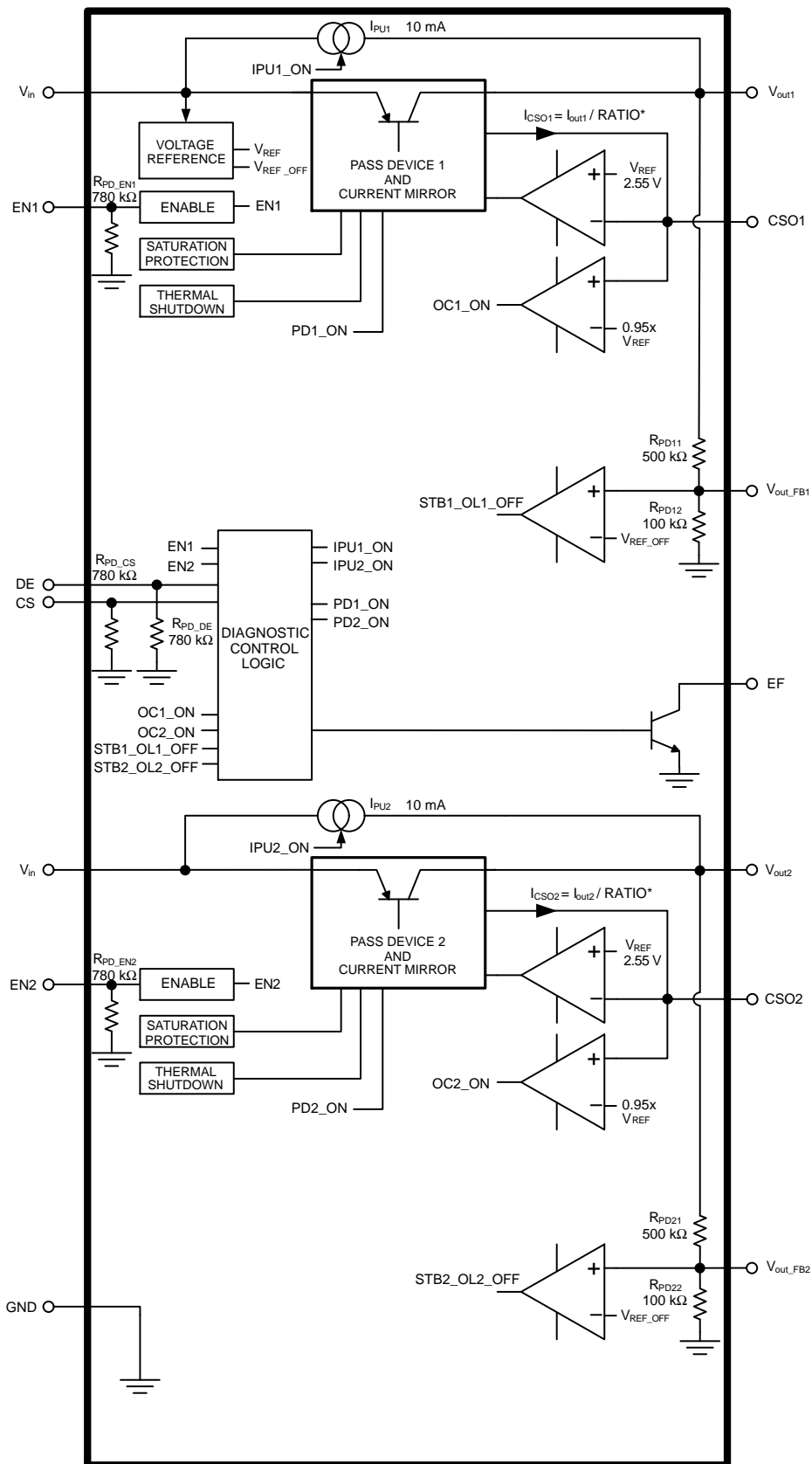

*) for current value of RATIO see into Electrical Characteristic Table

Figure 2. Simplified Block Diagram

NCV47822

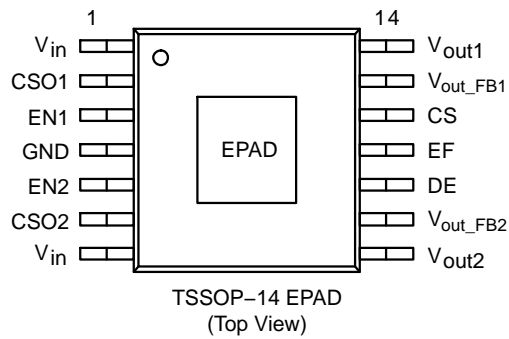

Figure 3. Pin Connections

Table 1. PIN FUNCTION DESCRIPTION

Pin No. TSSOP-14 EPAD	Pin Name	Description
1	V _{in}	Power Supply Input for Channel 1 and supply of control circuits of whole chip. At least 4.4 V power supply must be used for proper IC functionality.
2	CSO1	Current Sense Output 1, Current Limit setting and Output Current value information. See Application Section for more details.
3	EN1	Enable Input 1; low level disables the Channel 1. (Used also for OFF state diagnostics control for Channel 1)
4	GND	Power Supply Ground.
5	EN2	Enable Input 2; low level disables the Channel 2. (Used also for OFF state diagnostics control for Channel 2)
6	CSO2	Current Sense Output 2, Current Limit setting and Output Current value information. See Application Section for more details.
7	V _{in}	Power Supply Input for Channel 2. Connect to pin 1 or different power supply rail.
8	V _{out2}	Output Voltage 2.
9	V _{out_FB2}	Output Voltage 2 Analog Monitoring. See Application Section for more details.
10	DE	Diagnostic Enable Input.
11	EF	Error Flag (Open Collector) Output. Active Low.
12	CS	Channel Select Input for OFF state diagnostics. Set CS = Low for OFF state diagnostics of Channel 1. Set CS = High for OFF state diagnostics of Channel 2. Corresponding EN pin has to be used for diagnostics control (see Application Information section for more details).
13	V _{out_FB1}	Output Voltage 1 Analog Monitoring. See Application Section for more details.
14	V _{out1}	Output Voltage 1.
EPAD	EPAD	Exposed Pad is connected to Ground. Connect to GND plane on PCB.

Table 2. MAXIMUM RATINGS

Rating	Symbol	Min	Max	Unit
Input Voltage DC	V_{in}	-42	45	V
Input Voltage (Note 1) Load Dump – Suppressed	U_s^*	-	60	V
Enable Input Voltage	$V_{EN1,2}$	-42	45	V
Output Voltage Monitoring	$V_{out_FB1,2}$	-0.3	10	V
CSO Voltage	$V_{CSO1,2}$	-0.3	7	V
DE, CS and EF Voltages	V_{DE}, V_{CS}, V_{EF}	-0.3	7	V
Output Voltage	$V_{out1,2}$	-1	40	V
Junction Temperature	T_J	-40	150	°C
Storage Temperature	T_{STG}	-55	150	°C

Stresses exceeding those listed in the Maximum Ratings table may damage the device. If any of these limits are exceeded, device functionality should not be assumed, damage may occur and reliability may be affected.

1. Load Dump Test B (with centralized load dump suppression) according to ISO16750-2 standard. Guaranteed by design. Not tested in production. Passed Class A according to ISO16750-1.

Table 3. ESD CAPABILITY (Note 2)

Rating	Symbol	Min	Max	Unit
ESD Capability, Human Body Model	ESD_{HBM}	-2	2	kV

2. This device series incorporates ESD protection and is tested by the following methods:
 ESD Human Body Model tested per AEC-Q100-002 (JS-001-2010)
 Field Induced Charge Device Model ESD characterization is not performed on plastic molded packages with body sizes < 50 mm² due to the inability of a small package body to acquire and retain enough charge to meet the minimum CDM discharge current waveform characteristic defined in JEDEC JS-002-2014.

Table 4. MOISTURE SENSITIVITY LEVEL (Note 3)

Rating	Symbol	Min	Max	Unit
Moisture Sensitivity Level	MSL	1		-

3. For more information, please refer to our Soldering and Mounting Techniques Reference Manual, SOLDERRM/D

THERMAL CHARACTERISTICS (Note 4)

Rating	Symbol	Value	Unit
Thermal Characteristics (single layer PCB) Thermal Resistance, Junction-to-Air (Note 5) Thermal Reference, Junction-to-Lead (Note 5)	$R_{\theta JA}$ $R_{\psi JL}$	52 9.0	°C/W
Thermal Characteristics (4 layers PCB) Thermal Resistance, Junction-to-Air (Note 5) Thermal Reference, Junction-to-Lead (Note 5)	$R_{\theta JA}$ $R_{\psi JL}$	31 10	°C/W

4. Refer to ELECTRICAL CHARACTERISTICS and APPLICATION INFORMATION for Safe Operating Area.
5. Values based on copper area of 645 mm² (or 1 in²) of 1 oz copper thickness and FR4 PCB substrate. Single layer – according to JEDEC51.3, 4 layers – according to JEDEC51.7

Table 5. RECOMMENDED OPERATING RANGES

Rating	Symbol	Min	Max	Unit
Input Voltage (Note 6)	V_{in}	4.4	40	V
Output Current Limit (Note 7)	$I_{LIM1,2}$	10	350	mA
Junction Temperature	T_J	-40	150	°C
Current Sense Output (CSO) Capacitor	$C_{CSO1,2}$	1	4.7	μF

Functional operation above the stresses listed in the Recommended Operating Ranges is not implied. Extended exposure to stresses beyond the Recommended Operating Ranges limits may affect device reliability.

6. Minimum $V_{in} = 4.4$ V or ($V_{out1,2} + 0.5$ V), whichever is higher.
7. Corresponding $R_{CSO1,2}$ is in range from 76.5 kΩ down to 2185 Ω.

NCV47822

Table 6. ELECTRICAL CHARACTERISTICS $V_{in} = 13.5\text{ V}$, $V_{EN1,2} = 3.3\text{ V}$, $V_{DE} = 0\text{ V}$, $R_{CSO1,2} = 0\ \Omega$, $C_{CSO1,2} = 1\ \mu\text{F}$, $C_{in} = 1\ \mu\text{F}$, $C_{out1,2} = 1\ \mu\text{F}$, Min and Max values are valid for temperature range $-40^{\circ}\text{C} \leq T_J \leq +150^{\circ}\text{C}$ unless noted otherwise and are guaranteed by test, design or statistical correlation. Typical values are referenced to $T_J = 25^{\circ}\text{C}$ (Note 8)

Parameter	Test Conditions	Symbol	Min	Typ	Max	Unit
-----------	-----------------	--------	-----	-----	-----	------

OUTPUTS

Input to Output Differential Voltage	$V_{in} = 8\text{ V to }18\text{ V}$ $I_{out1,2} = 200\text{ mA}$ $I_{out1,2} = 250\text{ mA}$	$V_{in-out1,2}$	–	210	350	mV
			–	230	400	

CURRENT LIMIT PROTECTION

Current Limit	$V_{out1,2} = V_{in} - 1\text{ V}$	$I_{LIM1,2}$	350	–	–	mA
---------------	------------------------------------	--------------	-----	---	---	----

DISABLE AND QUIESCENT CURRENTS

Disable Current	$V_{EN1,2} = 0\text{ V}$	I_{DIS}	–	0.005	10	μA
Quiescent Current, $I_q = I_{in} - (I_{out1} + I_{out2})$	$I_{out1} = I_{out2} = 500\ \mu\text{A}$, $V_{in} = 8\text{ V to }18\text{ V}$	I_q	–	0.85	1.5	mA
Quiescent Current, $I_q = I_{in} - (I_{out1} + I_{out2})$	$I_{out1} = I_{out2} = 200\text{ mA}$, $V_{in} = 8\text{ V to }18\text{ V}$	I_q	–	15	25	mA
Quiescent Current, $I_q = I_{in} - (I_{out1} + I_{out2})$	$I_{out1} = I_{out2} = 250\text{ mA}$, $V_{in} = 8\text{ V to }18\text{ V}$	I_q	–	20	40	mA

ENABLE

Enable Input Threshold Voltage Logic Low (OFF) Logic High (ON)	$V_{out1,2} \leq 0.1\text{ V}$ $V_{out1,2} \geq V_{in} - 1\text{ V}$	$V_{th(EN1,2)}$	0.99	1.8	–	V
			–	1.9	2.31	
Enable Input Current	$V_{EN1,2} = 3.3\text{ V}$	$I_{EN1,2}$	2	7	20	μA
Turn On Time from Enable ON to $V_{out1,2} = V_{in} - 1\text{ V}$	$I_{out1,2} = 100\text{ mA}$	t_{on}	–	25	–	μs

OUTPUT CURRENT SENSE

CSO Voltage Level at Current Limit	$V_{out1,2} = V_{in} - 1\text{ V}$ $R_{CSO1,2} = 3.3\text{ k}\Omega$	$V_{CSO_Ilim1,2}$	2.448	2.55	2.652	V
			(–4%)		(+4%)	
CSO Transient Voltage Level	$C_{CSO1,2} = 4.7\ \mu\text{F}$, $R_{CSO1,2} = 3.3\text{ k}\Omega$, $I_{out1,2}$ pulse from 10 mA to 350 mA, $t_r = 1\ \mu\text{s}$	$V_{CSO1,2}$	–	–	3.3	V
Output Current to CSO Current Ratio	$V_{CSO1,2} = 2\text{ V}$, $I_{out1,2} = 10\text{ mA to }50\text{ mA}$ $V_{in} = 8\text{ V to }18\text{ V}$, $-40^{\circ}\text{C} \leq T_J \leq +150^{\circ}\text{C}$	$I_{out1,2}/I_{CSO1,2}$	–	265	–	–
	$V_{CSO1,2} = 2\text{ V}$, $I_{out1,2} = 50\text{ mA to }350\text{ mA}$ $V_{in} = 8\text{ V to }18\text{ V}$, $-40^{\circ}\text{C} \leq T_J \leq +150^{\circ}\text{C}$		(–15%)		(+15%)	
			–	285	–	
			(–5%)		(+5%)	
CSO Current at no Load Current	$V_{CSO1,2} = 0\text{ V}$, $I_{out1,2} = 0\text{ mA}$	$I_{CSO_off1,2}$	–	–	15	μA

DIAGNOSTICS

Overcurrent Voltage Level Threshold	$V_{out1,2} = V_{in} - 1\text{ V}$, $R_{CSO1,2} = 3.3\text{ k}\Omega$	$V_{OC1,2}$	92	95	98	% of $V_{CSO_Ilim1,2}$
Short To Battery (STB) Voltage Threshold in OFF state	$V_{in} = 4.4\text{ V to }18\text{ V}$, $I_{out1} = I_{out2} = 0\text{ mA}$, $V_{DE} = 3.3\text{ V}$	$V_{STB1,2}$	2	3	4	V
Open Load (OL) Current Threshold in OFF state	$V_{in} = 4.4\text{ V to }18\text{ V}$, $V_{DE} = 3.3\text{ V}$	$I_{OL1,2}$	5.0	10	25	mA
Output Voltage to Output Feedback Voltage Ratio	$V_{in} = 4.4\text{ V to }18\text{ V}$	$V_{out1,2}/V_{out_FB1,2}$	5.7	6.0	6.3	–
Diagnostics Enable Threshold Voltage Logic Low Logic High		$V_{th(DE)}$	0.99	1.8	–	V
			–	1.9	2.31	
Channel Select Threshold Voltage Logic Low Logic High		$V_{th(CS)}$	0.99	1.8	–	V
			–	1.9	2.31	
Error Flag Low Voltage	$I_{EF} = -1\text{ mA}$	V_{EF_Low}	–	0.04	0.4	V

Product parametric performance is indicated in the Electrical Characteristics for the listed test conditions, unless otherwise noted. Product performance may not be indicated by the Electrical Characteristics if operated under different conditions.

8. Performance guaranteed over the indicated operating temperature range by design and/or characterization tested at $T_A \approx T_J$. Low duty cycle pulse techniques are used during testing to maintain the junction temperature as close to ambient as possible.
9. Values based on design and/or characterization.

NCV47822

Table 6. ELECTRICAL CHARACTERISTICS $V_{in} = 13.5\text{ V}$, $V_{EN1,2} = 3.3\text{ V}$, $V_{DE} = 0\text{ V}$, $R_{CSO1,2} = 0\ \Omega$, $C_{CSO1,2} = 1\ \mu\text{F}$, $C_{in} = 1\ \mu\text{F}$, $C_{out1,2} = 1\ \mu\text{F}$, Min and Max values are valid for temperature range $-40^{\circ}\text{C} \leq T_J \leq +150^{\circ}\text{C}$ unless noted otherwise and are guaranteed by test, design or statistical correlation. Typical values are referenced to $T_J = 25^{\circ}\text{C}$ (Note 8)

Parameter	Test Conditions	Symbol	Min	Typ	Max	Unit
-----------	-----------------	--------	-----	-----	-----	------

THERMAL SHUTDOWN

Thermal Shutdown Temperature (Note 9)	I _{out1} = I _{out2} = 90 mA, each channel measured separately	T _{SD1,2}	150	175	195	°C
---------------------------------------	---	--------------------	-----	-----	-----	----

Product parametric performance is indicated in the Electrical Characteristics for the listed test conditions, unless otherwise noted. Product performance may not be indicated by the Electrical Characteristics if operated under different conditions.

- 8. Performance guaranteed over the indicated operating temperature range by design and/or characterization tested at $T_A \approx T_J$. Low duty cycle pulse techniques are used during testing to maintain the junction temperature as close to ambient as possible.
- 9. Values based on design and/or characterization.

TYPICAL CHARACTERISTICS

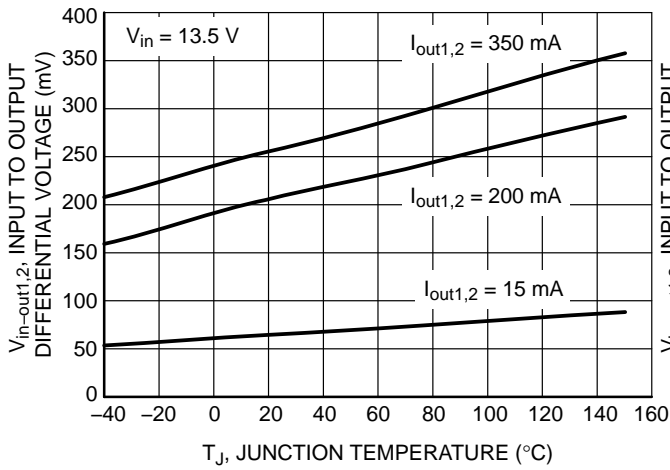

Figure 4. Input to Output Differential vs. Temperature

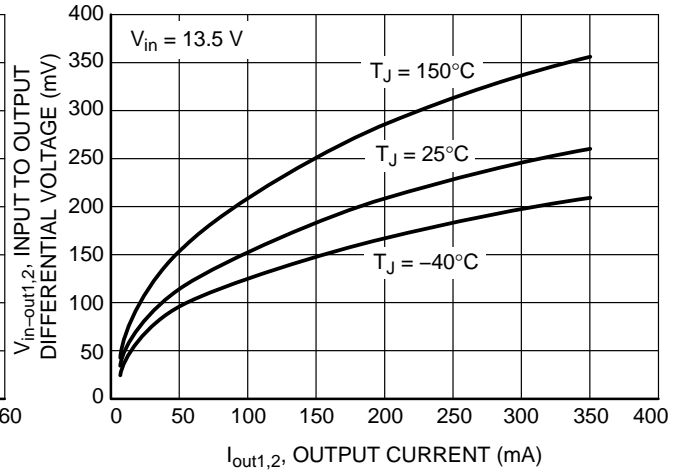

Figure 5. Input to Output Diff. vs. Output Current

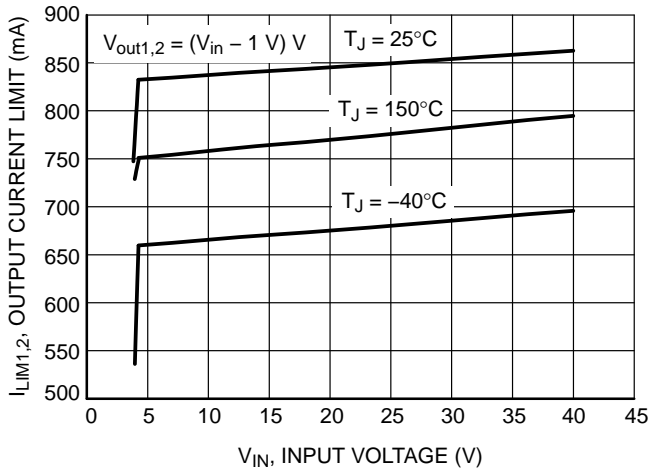

Figure 6. Output Current Limit vs. Input Voltage

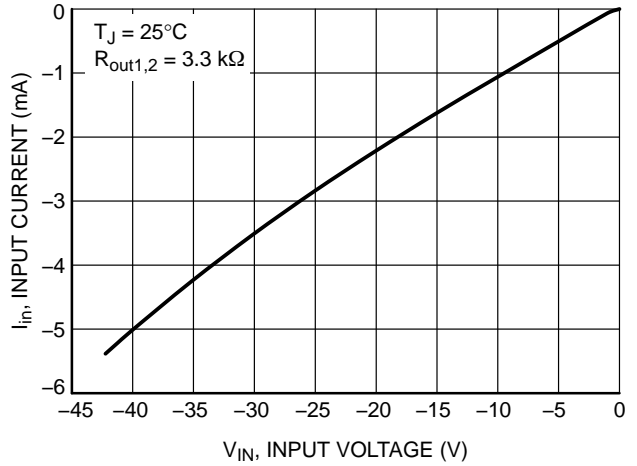

Figure 7. Output Voltage vs. Input Voltage (Reverse Input Voltage)

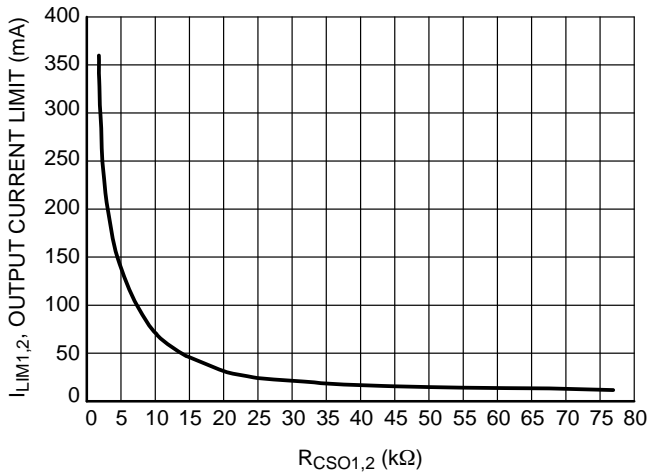

Figure 8. Output Current Limit vs. RcsO (Calculated Using E24 Series)

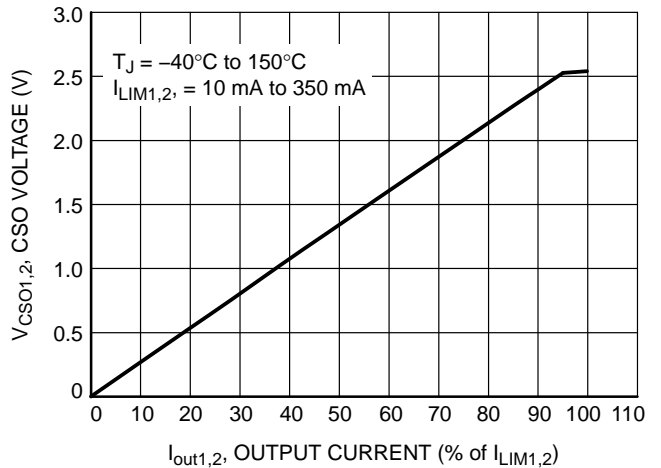

Figure 9. Output Current (% of ILIM) vs. CSO Voltage

TYPICAL CHARACTERISTICS

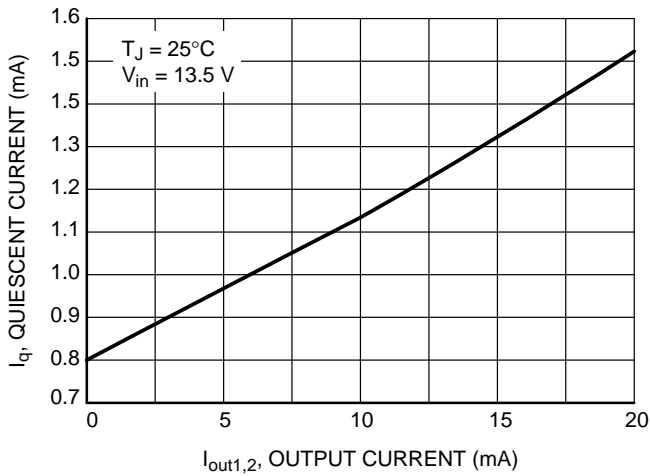

Figure 10. Quiescent Current vs. Output Current (Low Load)

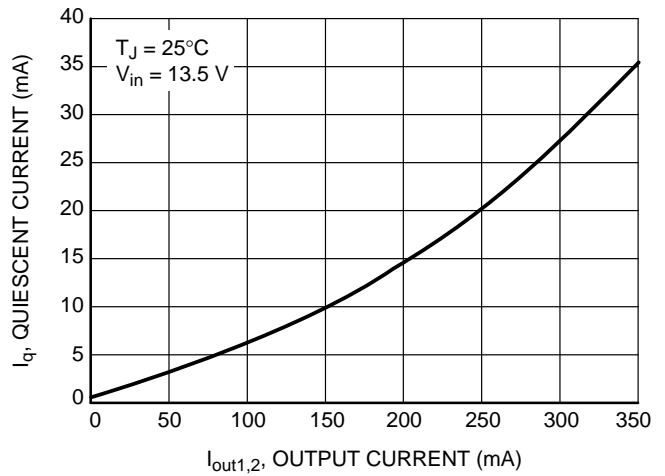

Figure 11. Quiescent Current vs. Output Current (High Load)

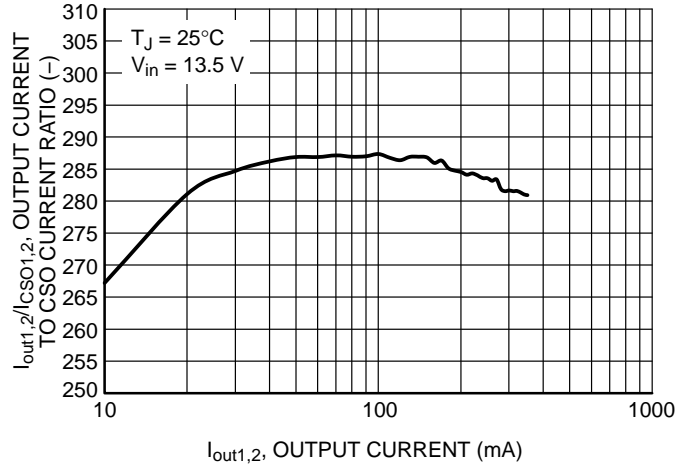

Figure 12. I_{CSO} Current vs. Output Current Ratio

DEFINITIONS

General

All measurements are performed using short pulse low duty cycle techniques to maintain junction temperature as close as possible to ambient temperature.

Input to Output Differential Voltage

The Input to Output Differential Voltage parameter is defined for specific output current values and specified over Temperature range.

Quiescent and Disable Currents

Quiescent Current (I_Q) is the difference between the input current (measured through the LDO input pin) and the output load current. If Enable pin is set to LOW the regulator reduces its internal bias and shuts off the output, this term is called the disable current (I_{DIS}).

Current Limit

Current Limit is value of output current by which output voltage drops below 90% of its nominal value.

Thermal Protection

Internal thermal shutdown circuitry is provided to protect the integrated circuit in the event that the maximum junction temperature is exceeded. When activated at typically 175°C, the regulator turns off. This feature is provided to prevent failures from accidental overheating.

Maximum Package Power Dissipation

The power dissipation level is maximum allowed power dissipation for particular package or power dissipation at which the junction temperature reaches its maximum operating value, whichever is lower.

APPLICATIONS INFORMATION

Circuit Description

The NCV47822 is an integrated dual High Side Switch (HSS) with output current capability up to 250 mA per each output. It is enabled with an input to the enable pin. The integrated current sense feature provides diagnosis and system protection functionality. The current limit of the device is adjustable by resistor connected to CSO pin. Voltage on CSO pin is proportional to output current. The HSS is protected by both current limit and thermal shutdown. Thermal shutdown occurs above 150°C to protect the IC during overloads and extreme ambient temperatures.

Enable Inputs

An enable pin is used to turn a channel on or off. By holding the pin down to a voltage less than 0.99 V, the output of the channel will be turned off. When the voltage on the enable pin is greater than 2.31 V, the output of the channel will be enabled to power its output to the regulated output voltage. The enable pins may be connected directly to the input pin to give constant enable to the output channel.

Setting the Output Current Limit

The output current limit can be set up to 350 mA by external resistor $R_{CSO1,2}$ (see Figure 1). Capacitor C_{CSO} of 1 μ F in parallel with R_{CSO} is required for stability of current limit control circuitry (see Figure 1).

$$V_{CSO1,2} = I_{out1,2} \left(R_{CSO1,2} \times \frac{1}{RATIO} \right) \quad (eq. 1)$$

$$I_{LIM1,2} = \frac{RATIO}{1} \times \frac{2.55}{R_{CSO1,2}} \quad (eq. 2)$$

$$R_{CSO1,2} = \frac{RATIO}{1} \times \frac{2.55}{I_{LIM1,2}} \quad (eq. 3)$$

where

- $R_{CSO1,2}$ – current limit setting resistor
- $V_{CSO1,2}$ - voltage at CSO pin proportional to $I_{out1,2}$
- $I_{LIM1,2}$ – current limit value
- $I_{out1,2}$ – output current actual value
- RATIO – typical value of Output Current to CSO Current Ratio for particular output current range

CSO pin provides information about output current actual value. The CSO voltage is proportional to output current according to Equation 1.

Once output current reaches its limit value ($I_{LIM1,2}$) set by external resistor R_{CSO} than voltage at CSO pin is typically 2.55 V. Calculations of $I_{LIM1,2}$ or $R_{CSO1,2}$ values can be done using equations Equation 2 and Equation 3, respectively. Minimum and maximum value of Output Current Limit can be calculated according Equation 4 and 5.

$$I_{LIM1,2_min} = RATIO_{min} \times \frac{V_{CSO1,2_min}}{R_{CSO1,2_max}} \quad (eq. 4)$$

$$I_{LIM1,2_max} = RATIO_{max} \times \frac{V_{CSO1,2_max}}{R_{CSO1,2_min}} \quad (eq. 5)$$

where

$RATIO_{min}$ – minimum value of Output Current to CSO Current Ratio from electrical characteristics table and particular output current range

$RATIO_{max}$ – maximum value of Output Current to CSO Current Ratio from electrical characteristics table and particular output current range

$V_{CSO1,2_min}$ - minimum value of CSO Voltage Level at Current Limit from electrical characteristics table

$V_{CSO1,2_max}$ - maximum value of CSO Voltage Level at Current Limit from electrical characteristics table

$R_{CSO1,2_min}$ – minimum value of $R_{CSO1,2}$ with respect its accuracy

$R_{CSO1,2_max}$ – maximum value of $R_{CSO1,2}$ with respect its accuracy

Designers should consider the tolerance of $R_{CSO1,2}$ during the design phase.

Diagnostic in OFF State

The NCV47822 contains also circuitry for OFF state diagnostics for Short to Battery (STB) and Open Load (OL). There are internal current sources and Pull Down resistors which provide additional cost savings for overall application

by excluding external components and their assembly cost and saving PCB space and safe control IOs of a Microcontroller Unit (MCU).

Simplified functional schematic and truth table is shown in Figure 13 and related flowchart in Figure 14.

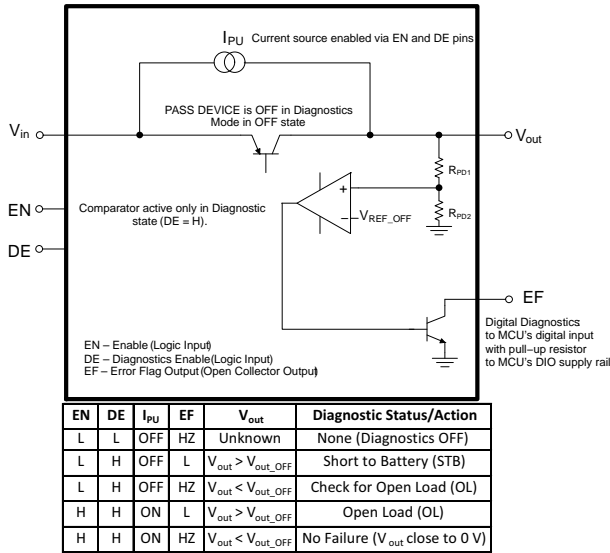

Figure 13. Simplified Functional Diagram of OFF State Diagnostics (STB and OL)

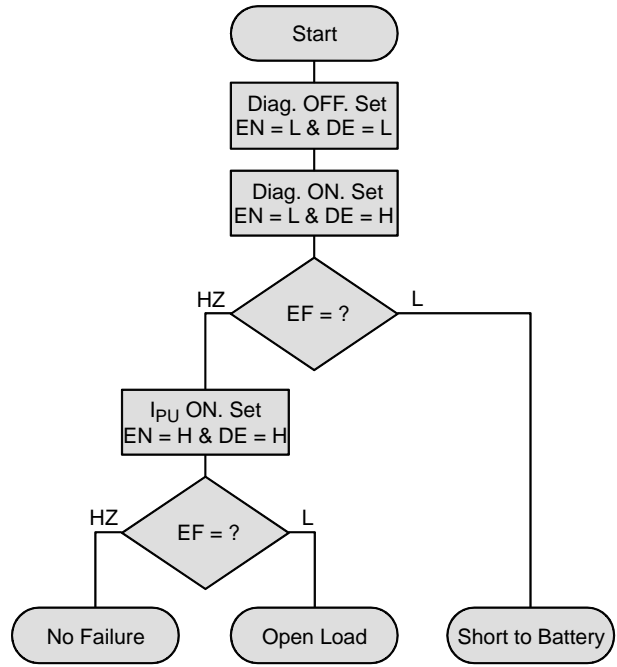

Figure 14. Flowchart for Diagnostics in OFF State

The diagnostics in OFF state shall be performed for each channel separately. For diagnostics of Channel 1 the input CS pin has to be put logic low, for diagnostics of Channel 2 the input CS pin has to be put logic high. Corresponding EN pin has to be used for control (EN1 for Channel 1 and EN2 for Channel 2).

Diagnostic in ON State

Diagnostic in ON State provides information about Overcurrent or Short to Ground failures, during which the EF output is in logic low state. The diagnostics in ON state shall be performed for each channel separately. For diagnostics of Channel 1 the input CS pin has to be put logic low, for diagnostics of Channel 2 the input CS pin has to be put logic high. For detailed information see Diagnostic Features Truth Table in Figure 15.

Output Voltage Monitoring

The Output Voltage net is connected to internal resistor divider. Output of the resistor divider is connected to V_{out_FB1,2} pin and provides information about Output Voltage Level according to Equation 4.

$$V_{out_FB1,2} = \frac{V_{out1,2}}{6} \quad (\text{eq. 6})$$

Operational Status	EN ¹⁰⁾	DE	CS	Output Voltage (V _{out1} or V _{out2})	Diagnostic Output (CSO1 or CSO2)	Error Flag (EF)
Disabled	L	L	X	Low (~0 V)	Low (~0 V)	HZ
Short to Battery	L	H	L/H ¹¹⁾	High (V _{out} ~ V _{in})	Low (~0 V)	L ¹²⁾
Open Load (OFF)	H	H	L/H ¹¹⁾	High (V _{out} ~ V _{in})	Low (~0 V)	L ¹³⁾
Normal (OFF)	H	H	L/H ¹¹⁾	Low (~0 V)	Low (~0 V)	HZ ¹³⁾
Open Load (ON)	H	L	X	V _{out_nom}	Low (~0 V)	HZ
Normal (ON)	H	L	X	V _{out_nom}	Proportional to I _{out} (±10 %)	HZ
Over Current	H	L	L/H ¹⁴⁾	V _{out_nom} - 1 V	High (~2.55 V)	L
Short to Ground	H	L	L/H ¹⁴⁾	Low (~0 V)	High (~2.55 V)	L

Figure 15. Diagnostic Features Truth Table

10. State of EN pin of appropriate channel

11. CS = L means CH1 diagnostics and CS = H means CH2 diagnostics in OFF state (DE = H) via EF output, appropriate EN pin is used for turning internal switch ON and OFF (e.g. when DE = H and CS = L and EN1 = L then IPU1 is OFF, when DE = H and CS = L and EN1 = H then IPU1 is ON)

12. Internal current source turned OFF (between V_{out} and V_{in} of appropriate channel)

13. Internal current source turned ON (between V_{out} and V_{in} of appropriate channel)

14. CS = L means CH1 diagnostics and CS = H means CH2 diagnostics in ON state (e.g. when CS = L and EF = L then CH1 has Overcurrent or Short to Ground failure, when CS = H and EF = L then CH1 has Overcurrent or Short to Ground failure)

Thermal Considerations

As power in the device increases, it might become necessary to provide some thermal relief. The maximum power dissipation supported by the device is dependent upon board design and layout. Mounting pad configuration on the PCB, the board material, and the ambient temperature affect the rate of junction temperature rise for the part. When the device has good thermal conductivity through the PCB, the junction temperature will be relatively low with high power applications. The maximum dissipation the device can handle is given by:

$$P_{D(MAX)} = \frac{[T_{J(MAX)} - T_A]}{R_{\theta JA}} \quad (\text{eq. 7})$$

Since T_J is not recommended to exceed 150°C, then the device soldered on 645 mm², 1 oz copper area, FR4 can dissipate up to 2.38 W when the ambient temperature (T_A) is 25°C. See Figure 16 for $R_{\theta JA}$ versus PCB area. The power dissipated by the device can be calculated from the following equations:

$$P_D \approx V_{in}(I_q @ I_{out1,2}) + I_{out1}(V_{in} - V_{out1}) + I_{out2}(V_{in} - V_{out2}) \quad (\text{eq. 8})$$

or

$$V_{in(MAX)} \approx \frac{P_{D(MAX)} + (V_{out1} \times I_{out1}) + (V_{out2} \times I_{out2})}{I_{out1} + I_{out2} + I_q} \quad (\text{eq. 9})$$

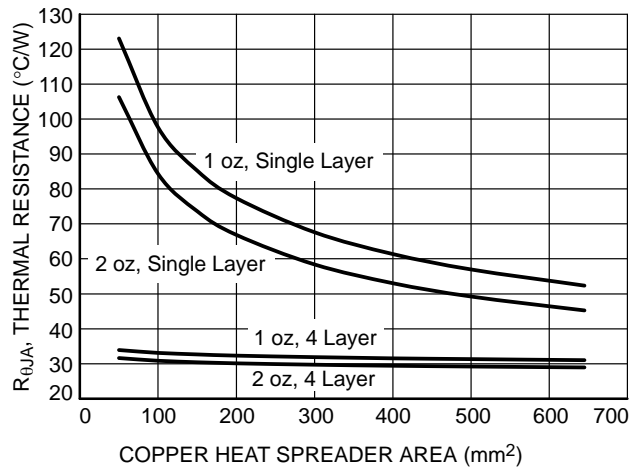

Figure 16. Thermal Resistance vs. PCB Copper Area

Hints

V_{in} and GND printed circuit board traces should be as wide as possible. When the impedance of these traces is high, there is a chance to pick up noise or cause the regulator to malfunction. Place external components, especially the output capacitor, as close as possible to the device and make traces as short as possible.

The Output Voltage Monitoring Output is high impedance output (see Figure 2) and during OFF state diagnostics it may be prone to couple a noise via PCB track or wire. Disturbing may appear as Error Flag Output oscillation when Output Voltage Level is close to Short to Battery threshold. To improve robustness connect capacitor (typically 10 nF) between each $V_{out_FB1,2pin}$ and GND as close as possible to the $V_{out_FB1,2}$ pins.

ORDERING INFORMATION

Device	Marking	Package	Shipping†
NCV47822PAAJR2G	Line1: NCV4 Line2: 7822	TSSOP-14 Exposed Pad (Pb-Free)	2500 / Tape & Reel

†For information on tape and reel specifications, including part orientation and tape sizes, please refer to our Tape and Reel Packaging Specifications Brochure, BRD8011/D

MECHANICAL CASE OUTLINE

PACKAGE DIMENSIONS

ON Semiconductor®

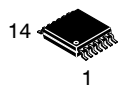

SCALE 1:1

TSSOP-14 EP CASE 948AW ISSUE C

DATE 09 OCT 2012

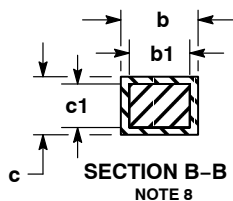
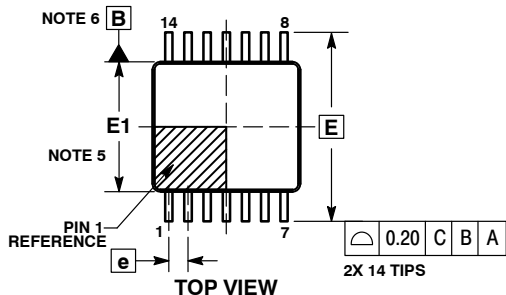

- NOTES:
1. DIMENSIONING AND TOLERANCING PER ASME Y14.5M, 1994.
 2. CONTROLLING DIMENSION: MILLIMETERS.
 3. DIMENSION b DOES NOT INCLUDE DAMBAR PROTRUSION. ALLOWABLE PROTRUSION SHALL BE 0.07 mm MAX. AT MAXIMUM MATERIAL CONDITION. DAMBAR CANNOT BE LOCATED ON THE LOWER RADII OF THE FOOT. MINIMUM SPACE BETWEEN PROTRUSION AND ADJACENT LEAD IS 0.07.
 4. DIMENSION D DOES NOT INCLUDE MOLD FLASH, PROTRUSIONS OR GATE BURRS. MOLD FLASH, PROTRUSIONS OR GATE BURRS SHALL NOT EXCEED 0.15 mm PER SIDE. DIMENSION D IS DETERMINED AT DATUM H.
 5. DIMENSION E1 DOES NOT INCLUDE INTERLEAD FLASH OR PROTRUSIONS. INTERLEAD FLASH OR PROTRUSIONS SHALL NOT EXCEED 0.25 mm PER SIDE. DIMENSION E1 IS DETERMINED AT DATUM H.
 6. DATUMS A AND B ARE DETERMINED AT DATUM H.
 7. A1 IS DEFINED AS THE VERTICAL DISTANCE FROM THE SEATING PLANE TO THE LOWEST POINT ON THE PACKAGE BODY.
 8. SECTION B-B TO BE DETERMINED AT 0.10 TO 0.25 mm FROM THE LEAD TIP.

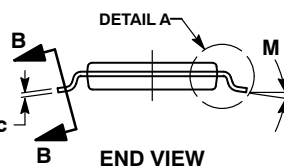
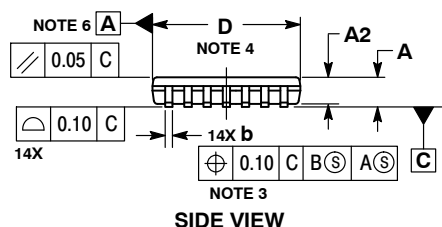

MILLIMETERS		
DIM	MIN	MAX
A	---	1.20
A1	0.05	0.15
A2	0.80	1.05
b	0.19	0.30
b1	0.19	0.25
c	0.09	0.20
c1	0.09	0.16
D	4.90	5.10
D2	3.09	3.62
E	6.40 BSC	
E1	4.30	4.50
E2	2.69	3.22
e	0.65 BSC	
L	0.45	0.75
L2	0.25 BSC	
M	0°	8°

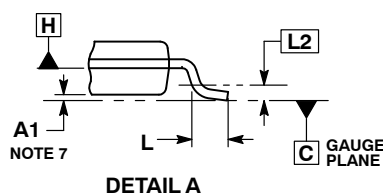
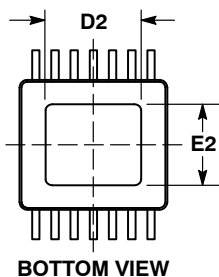

RECOMMENDED SOLDERING FOOTPRINT*

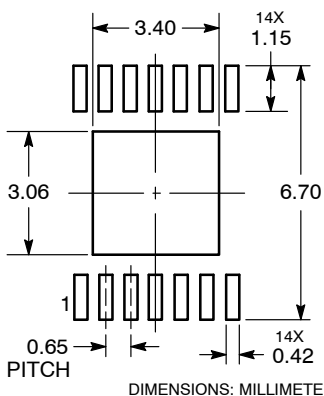

GENERIC MARKING DIAGRAM*

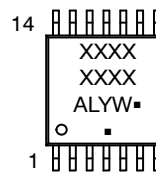

- XXXX = Specific Device Code
- A = Assembly Location
- L = Wafer Lot
- Y = Year
- W = Work Week
- = Pb-Free Package

(Note: Microdot may be in either location)

*This information is generic. Please refer to device data sheet for actual part marking. Pb-Free indicator, "G" or microdot "▪", may or may not be present.

*For additional information on our Pb-Free strategy and soldering details, please download the ON Semiconductor Soldering and Mounting Techniques Reference Manual, SOLDERRM/D.

DOCUMENT NUMBER:	98AON66474E	Electronic versions are uncontrolled except when accessed directly from the Document Repository. Printed versions are uncontrolled except when stamped "CONTROLLED COPY" in red.
DESCRIPTION:	TSSOP-14 EP, 5.0X4.4	PAGE 1 OF 1

ON Semiconductor and ON are trademarks of Semiconductor Components Industries, LLC dba ON Semiconductor or its subsidiaries in the United States and/or other countries. ON Semiconductor reserves the right to make changes without further notice to any products herein. ON Semiconductor makes no warranty, representation or guarantee regarding the suitability of its products for any particular purpose, nor does ON Semiconductor assume any liability arising out of the application or use of any product or circuit, and specifically disclaims any and all liability, including without limitation special, consequential or incidental damages. ON Semiconductor does not convey any license under its patent rights nor the rights of others.

onsemi, **Onsemi**, and other names, marks, and brands are registered and/or common law trademarks of Semiconductor Components Industries, LLC dba "**onsemi**" or its affiliates and/or subsidiaries in the United States and/or other countries. **onsemi** owns the rights to a number of patents, trademarks, copyrights, trade secrets, and other intellectual property. A listing of **onsemi**'s product/patent coverage may be accessed at www.onsemi.com/site/pdf/Patent-Marking.pdf. **onsemi** reserves the right to make changes at any time to any products or information herein, without notice. The information herein is provided "as-is" and **onsemi** makes no warranty, representation or guarantee regarding the accuracy of the information, product features, availability, functionality, or suitability of its products for any particular purpose, nor does **onsemi** assume any liability arising out of the application or use of any product or circuit, and specifically disclaims any and all liability, including without limitation special, consequential or incidental damages. Buyer is responsible for its products and applications using **onsemi** products, including compliance with all laws, regulations and safety requirements or standards, regardless of any support or applications information provided by **onsemi**. "Typical" parameters which may be provided in **onsemi** data sheets and/or specifications can and do vary in different applications and actual performance may vary over time. All operating parameters, including "Typicals" must be validated for each customer application by customer's technical experts. **onsemi** does not convey any license under any of its intellectual property rights nor the rights of others. **onsemi** products are not designed, intended, or authorized for use as a critical component in life support systems or any FDA Class 3 medical devices or medical devices with a same or similar classification in a foreign jurisdiction or any devices intended for implantation in the human body. Should Buyer purchase or use **onsemi** products for any such unintended or unauthorized application, Buyer shall indemnify and hold **onsemi** and its officers, employees, subsidiaries, affiliates, and distributors harmless against all claims, costs, damages, and expenses, and reasonable attorney fees arising out of, directly or indirectly, any claim of personal injury or death associated with such unintended or unauthorized use, even if such claim alleges that **onsemi** was negligent regarding the design or manufacture of the part. **onsemi** is an Equal Opportunity/Affirmative Action Employer. This literature is subject to all applicable copyright laws and is not for resale in any manner.

ADDITIONAL INFORMATION

TECHNICAL PUBLICATIONS:

Technical Library: www.onsemi.com/design/resources/technical-documentation
onsemi Website: www.onsemi.com

ONLINE SUPPORT: www.onsemi.com/support

For additional information, please contact your local Sales Representative at www.onsemi.com/support/sales