

BC856AW-HF Thru. BC858CW-HF

PNP

RoHS Device

Halogen Free

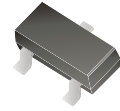

Features

- Ideally suited for automatic insertion.
- For switching and AF amplifier applications.

Mechanical data

- Case: SOT-323, molded plastic.
- Terminals: Solderable per MIL-STD-750, method 2026.

Circuit diagram

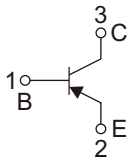

1 B : BASE
2 E : EMITTER
3 C : COLLECTOR

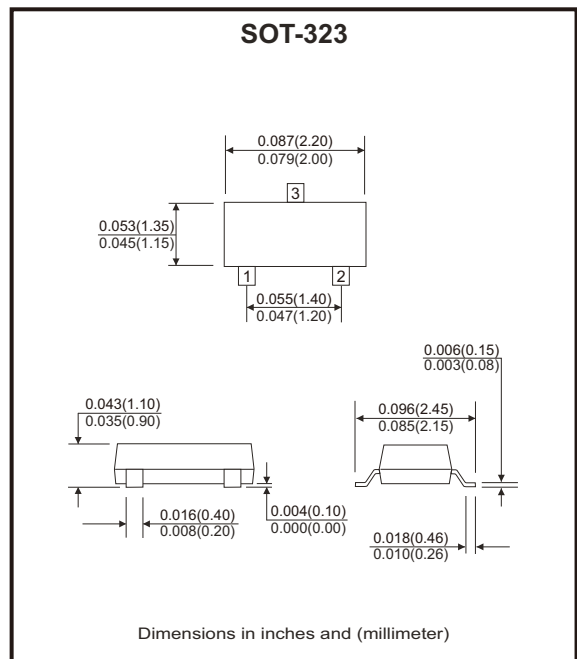

Maximum Ratings (Ta=25°C unless otherwise noted)

Parameter	Symbol	Value	Unit
Collector-Base voltage	V_{CBO}	-80 -50 -30	V
Collector-Emitter voltage	V_{CEO}	-65 -45 -30	V
Emitter-Base voltage	V_{EBO}	-5	V
Collector current-continuous	I_C	-0.1	A
Collector power dissipation	P_C	150	mW
Thermal resistance from junction to ambient	$R_{\theta JA}$	833	°C/W
Junction temperature	T_J	150	°C
Storage temperature range	T_{STG}	-65 to +150	°C

Electrical Characteristics (Ta= 25°C unless otherwise specified)

Parameter	Symbol	Test Conditions	Min.	Max.	Unit
Collector-Base breakdown voltage BC856W-HF BC857W-HF BC858W-HF	V_{CBO}	$I_C = -10\mu A, I_E = 0$	-80 -50 -30		V
Collector-Emitter breakdown voltage BC856W-HF BC857W-HF BC858W-HF	V_{CEO}	$I_C = -10mA, I_B = 0$	-65 -45 -30		V
Emitter-Base breakdown voltage	V_{EBO}	$I_E = -1\mu A, I_C = 0$	-5		V
Collector cut-off current	I_{CBO}	$V_{CB} = -30V, I_E = 0$		-15	nA
DC current gain BC856AW, BC857AW, BC858AW BC856BW, BC857BW, BC858BW BC857CW, BC858CW	h_{FE}	$V_{CE} = -5V, I_C = -2mA$	125 220 420	250 475 800	
Collector-Emitter saturation voltage	$V_{CE(sat)}$	$I_C = -100mA, I_B = -5mA$		-0.65	V
Base-Emitter saturation voltage	$V_{BE(sat)}$	$I_C = -100mA, I_B = -5mA$		-1.1	V
Transition frequency	f_T	$V_{CE} = -5V, I_C = -10mA, f = 100MHz$	100		MHz
Collector capacitance	C_{ob}	$V_{CB} = -10V, f = 1MHz$		4.5	pF

Electrical Characteristic Curves (BC856AW-HF Thru. BC858CW-HF)

Fig.1 - Static Characteristic

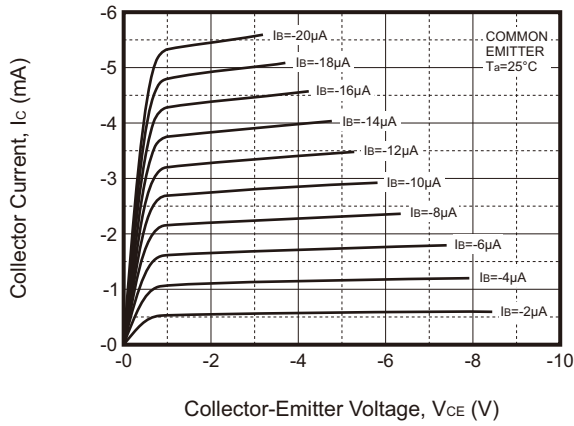

Fig.2 - h_{FE} — I_c

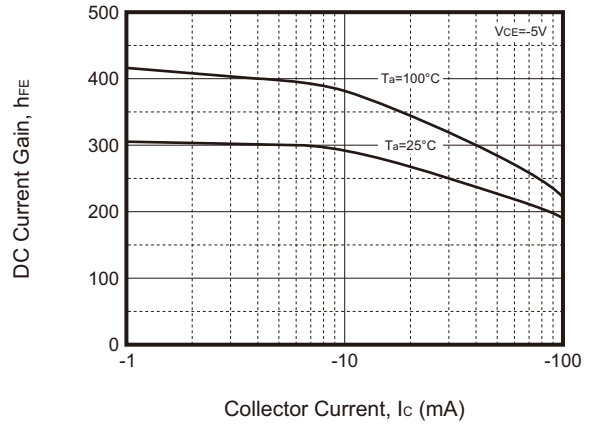

Fig.3 - V_{BEsat} — I_c

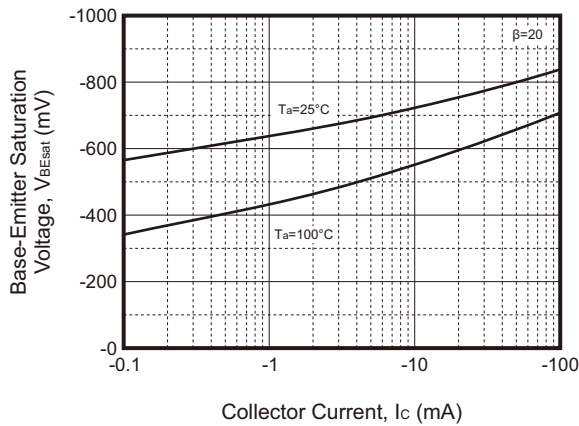

Fig.4 - V_{CEsat} — I_c

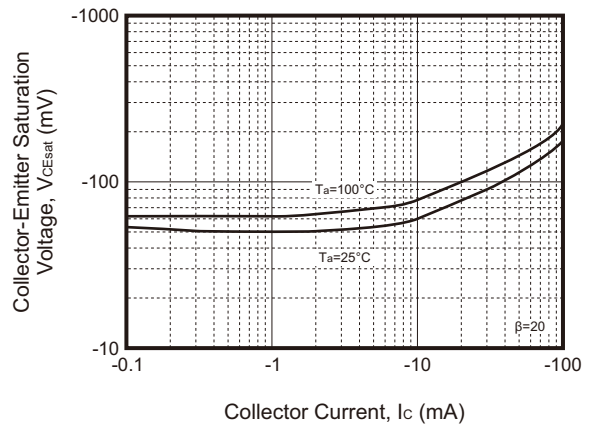

Fig.5 - C_{ob} / C_{ib} — V_{CB} / V_{EB}

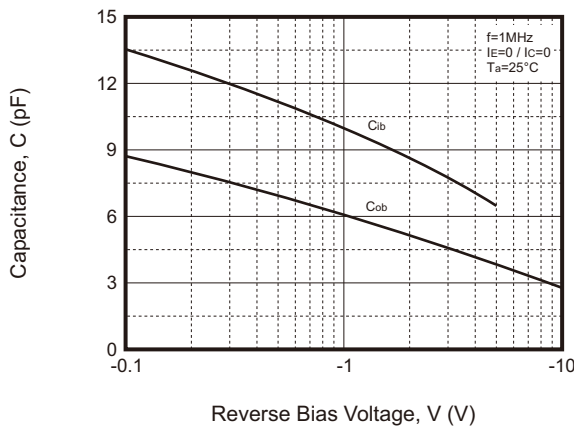
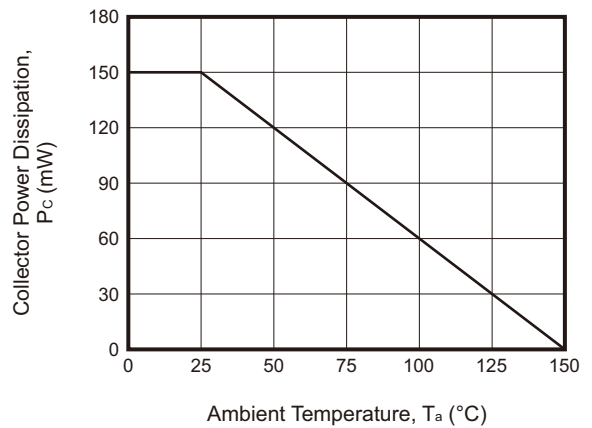
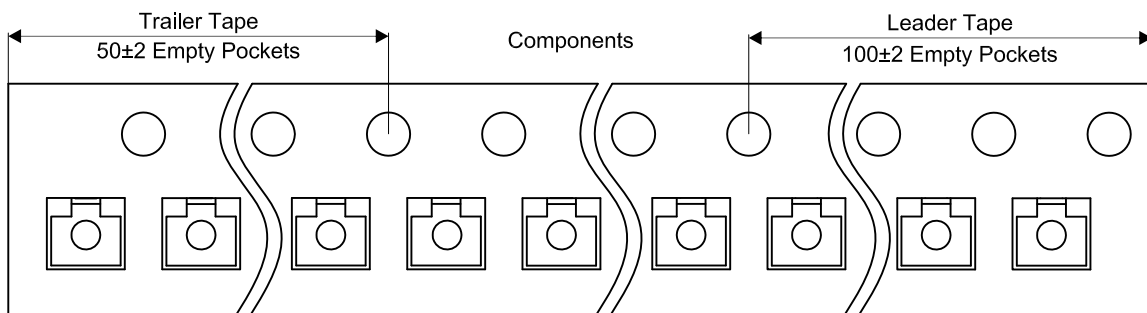
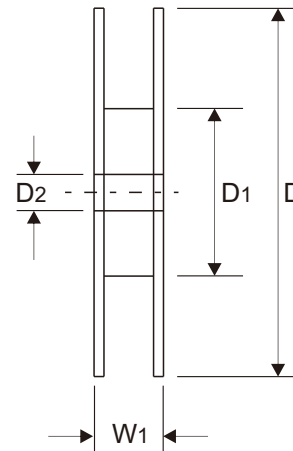
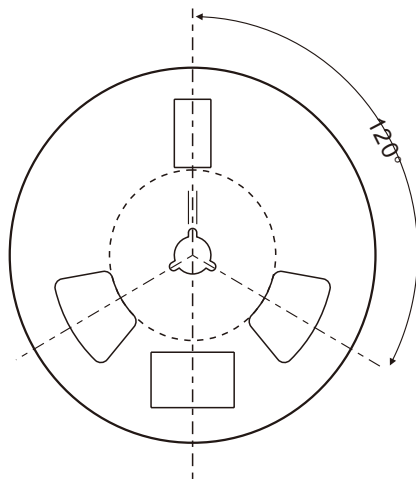
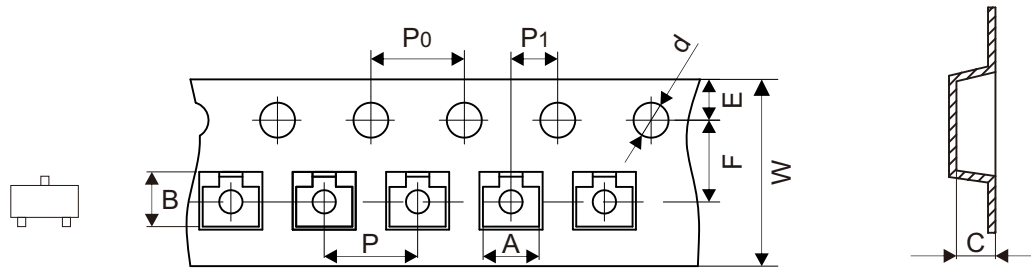

Fig.6 - P_c — T_a



Reel Taping Specification



SOT-323	SYMBOL	A	B	C	d	D	D1	D2
	(mm)	2.25 ± 0.05	2.55 ± 0.05	1.19 ± 0.05	1.55 ± 0.10	178.00 ± 2.00	54.40 ± 1.00	13.00 ± 1.00
	(inch)	0.089 ± 0.002	0.100 ± 0.002	0.047 ± 0.002	0.061 ± 0.004	7.008 ± 0.079	2.142 ± 0.039	0.512 ± 0.039

SOT-323	SYMBOL	E	F	P	P0	P1	W	W1
	(mm)	1.75 ± 0.10	3.50 ± 0.10	4.00 ± 0.10	4.00 ± 0.10	2.00 ± 0.10	8.00 + 0.30 - 0.10	12.30 ± 1.00
	(inch)	0.069 ± 0.004	0.138 ± 0.004	0.157 ± 0.004	0.157 ± 0.004	0.079 ± 0.004	0.315 + 0.012 - 0.004	0.484 ± 0.039

Marking Code

Part Number	Marking Code
BC856AW-HF	3A
BC857AW-HF	3E
BC858AW-HF	3J
BC856BW-HF	3B
BC857BW-HF	3F
BC858BW-HF	3K
BC857CW-HF	3G
BC858CW-HF	3L

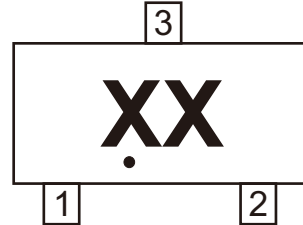

xx = Product type marking code
 . = Halogen Free

Suggested PAD Layout

SIZE	SOT-323	
	(mm)	(inch)
A	0.50	0.020
B	0.80	0.031
C	1.30	0.051
D	2.20	0.087

Notes:
 1. General tolerance : ±0.05mm.
 2. The pad layout is for reference purposes only.

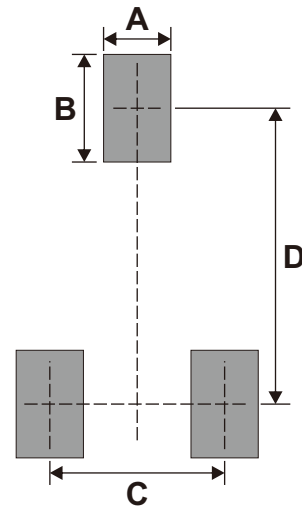

Standard Packaging

Case Type	REEL PACK	
	REEL (pcs)	Reel Size (inch)
SOT-323	3,000	7