

# Features

- 2:1 input voltage range
- 1.6kVDC isolation
- UL certified

# Regulated Converter

- Efficiency up to 89%
- Six-sided continuous shield
- No minimum load required



# RP15-A

15 Watt

1" x 1"

Single and Dual Output



## Description

The RP15-A series are ultraminiature power DC/DC converters in a case half the size of industry standard 15W converters. Despite their small size, the RP15-A converters are fully specified devices with output currents up to 4 Amps, no minimum load, 1600VDC isolation and low ripple/noise figures. The outputs are also fully protected against short circuits, overcurrent and overvoltage. The RP15-A series will find many uses in applications where board space and/or board height is at a premium.

## Selection Guide

Part Number	Input Voltage Range [VDC]	Output Voltage [VDC]	Output Current [mA]	Input <sup>(1)</sup> Current [mA]	Efficiency <sup>(1)</sup> typ. [%]	Max. Capacitive Load <sup>(2)</sup> [µF]
RP15-123.3SA <sup>(3,4)</sup>	9-18	3.3	4000	1310	84	12000
RP15-1205SA <sup>(3,4)</sup>	9-18	5	3000	1420	88	6000
RP15-1212SA <sup>(3,4)</sup>	9-18	12	1300	1512	86	1000
RP15-1215SA <sup>(3,4)</sup>	9-18	15	1000	1420	88	660
RP15-243.3SA <sup>(3,4)</sup>	18-36	3.3	4000	640	86	12000
RP15-2405SA <sup>(3,4)</sup>	18-36	5	3000	710	88	6000
RP15-2412SA <sup>(3,4)</sup>	18-36	12	1300	747	87	1000
RP15-2415SA <sup>(3,4)</sup>	18-36	15	1000	710	88	660
RP15-483.3SA <sup>(3,4)</sup>	36-75	3.3	4000	320	86	12000
RP15-4805SA <sup>(3,4)</sup>	36-75	5	3000	355	88	6000
RP15-4812SA <sup>(3,4)</sup>	36-75	12	1300	369	88	1000
RP15-4815SA <sup>(3,4)</sup>	36-75	15	1000	355	88	660
RP15-1205DA <sup>(3,4)</sup>	9-18	±5	±1500	1471	85	±3000
RP15-1212DA <sup>(3,4)</sup>	9-18	±12	±625	1437	87	±520
RP15-1215DA <sup>(3,4)</sup>	9-18	±15	±500	1420	88	±330
RP15-2405DA <sup>(3,4)</sup>	18-36	±5	±1500	735	85	±3000
RP15-2412DA <sup>(3,4)</sup>	18-36	±12	±625	710	88	±520
RP15-2415DA <sup>(3,4)</sup>	18-36	±15	±500	710	88	±330
RP15-4805DA <sup>(3,4)</sup>	36-75	±5	±1500	368	85	±3000
RP15-4812DA <sup>(3,4)</sup>	36-75	±12	±625	351	89	±520
RP15-4815DA <sup>(3,4)</sup>	36-75	±15	±500	355	88	±330



UL60950-1 certified

### Notes:

- Note1: Maximum values at nominal input voltage and full load  
 Note2: Max. Cap load is tested at minimum Input and constant resistive load

## Model Numbering

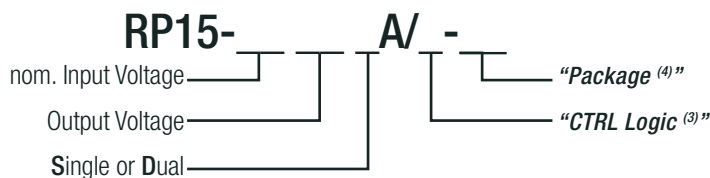

### Notes:

- Note3: no suffix for standard part without Trim or CTRL pin  
 add suffix "P" for CTRL function with positive logic (1=ON, 0=OFF) and Trim pin  
 add suffix "N" for CTRL function with negative logic (0=ON, 1=OFF) and Trim pin  
 Note4: add suffix "-HC" for premounted Heat-sink with clamps

### Ordering Examples

- RP15-2405SA/P = 24V input, 5V output, single, positive Logic CTRL pin  
 RP15-4805DA-HC = 48V input, ±5V output, dual, without CTRL pin, Heat-sink premounted

**Specifications** (measured @ Ta= 25°C, nom. Vin, full load unless otherwise stated)

**BASIC CHARACTERISTICS**

Parameter	Condition		Min.	Typ.	Max.
Input Filter			Pi-Type		
Input Voltage Range	nom. Vin = 12VDC nom. Vin = 24VDC nom. Vin = 48VDC		9VDC 18VDC 36VDC	12VDC 24VDC 48VDC	18VDC 36VDC 75VDC
Input Surge Voltage	100s max.	nom. Vin = 12VDC nom. Vin = 24VDC nom. Vin = 48VDC			36VDC 50VDC 100VDC
Under Voltage Lockout (UVLO)	nom. Vin = 12VDC	DC-DC ON DC-DC OFF		8VDC	9VDC
	nom. Vin = 24VDC	DC-DC ON DC-DC OFF		14.5VDC	18VDC
	nom. Vin = 48VDC	DC-DC ON DC-DC OFF		30.5VDC	36VDC
Input Reflected Ripple Current <sup>(5)</sup>				30mA <sub>p-p</sub>	
Output Voltage Trimming	refer to <b>"OUTPUT VOLTAGE TRIMMING"</b>		-10%		+10%
Minimum Load			0%		
Start-up Time	Power up ON/OFF CTRL				30ms 30ms
ON/OFF CTRL <sup>(6)</sup>	Positive Logic	DC-DC ON DC-DC OFF	Open or 3.0VDC < V <sub>CTRL</sub> < 15VDC Short or 0VDC < V <sub>CTRL</sub> < 1.2VDC		
	Negative Logic	DC-DC ON DC-DC OFF	Short or 0VDC < V <sub>CTRL</sub> < 1.2VDC Open or 3.0VDC < V <sub>CTRL</sub> < 15VDC		
Input Current of CTRL pin	DC-DC ON		-0.5mA		+1.0mA
Standby Current	DC-DC OFF			2.5mA	
Internal Operating Frequency			360kHz	400kHz	440kHz
Ripple and Noise	measured at 20MHz BW, with a 1µF M/C X7R and 10µF T/C	3.3V <sub>out</sub> , 5V <sub>out</sub> 12V <sub>out</sub> , 15V <sub>out</sub>		75mV <sub>p-p</sub> 100mV <sub>p-p</sub>	
		±5V <sub>out</sub> , ±12V <sub>out</sub> , ±15V <sub>out</sub>		100mV <sub>p-p</sub>	

**Notes:**

Note5: Simulated source impedance of 12µH. 12µH inductor in series with +Vin

Note6: If no suffix is specified, the control pin will be omitted. If fitted, the ON/OFF control function can be positive or negative logic. The pin voltage is referenced to -Vin pin

**RP15-1205SA**

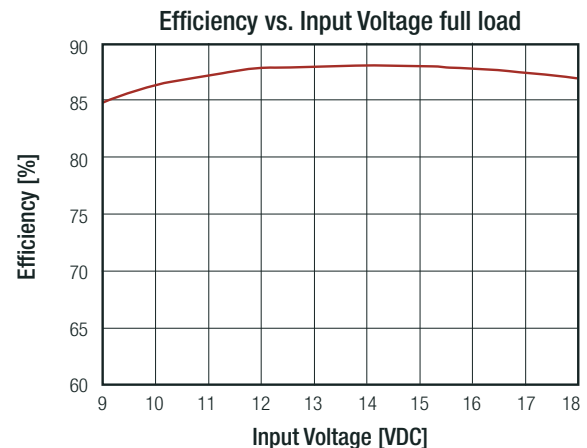
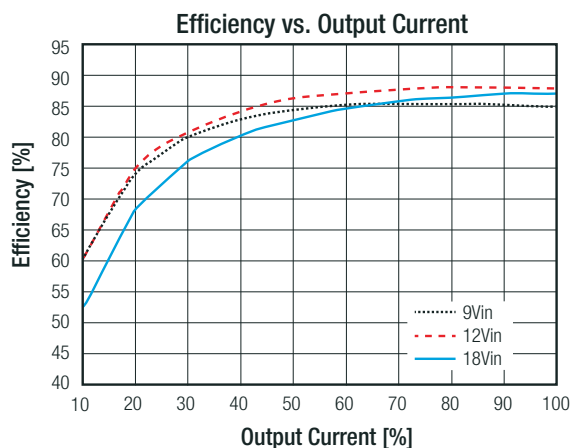

continued on next page

Specifications (measured @ Ta= 25°C, nom. Vin, full load unless otherwise stated)

### RP15-2405SA

Efficiency vs. Output Current

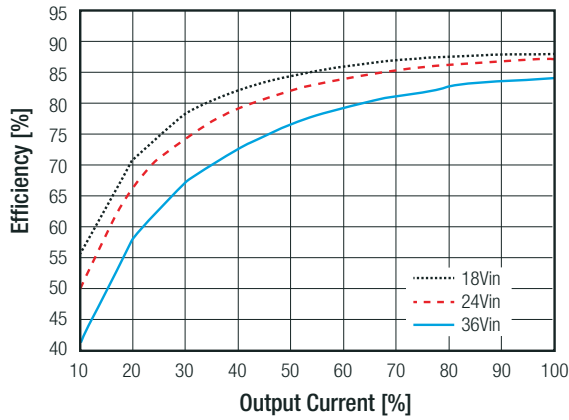

Efficiency vs. Input Voltage

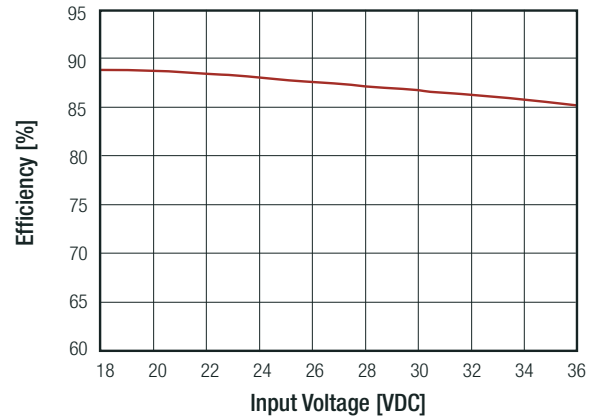

### RP15-4805SA

Efficiency vs. Output Current

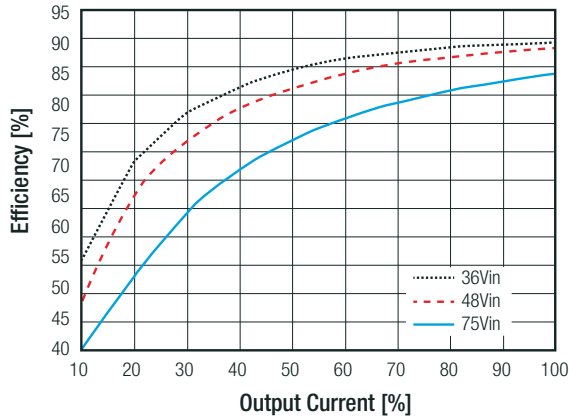

Efficiency vs. Input Voltage

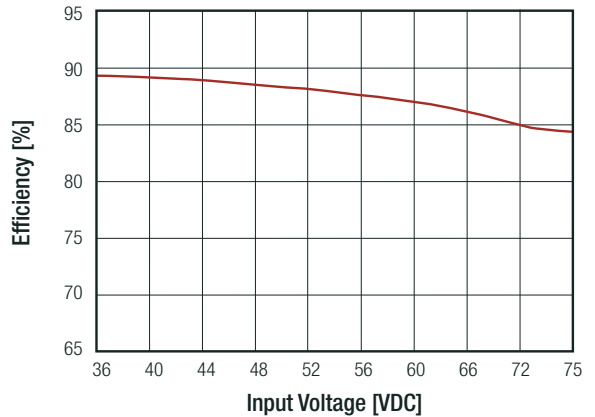

## OUTPUT VOLTAGE TRIMMING

### Output Voltage Trimming

Single output Powerline converters offer the feature of trimming the output voltage over a certain range around the nominal value by using external trim resistors. No general equation can be given for calculating the trim resistors, but the following trimtables give typical values for choosing these trimming resistors. If voltages between the given trim points are required, extrapolate between the two nearest given values to work out the resistor required or use a variable resistor to set the output voltage. Output can be externally trimmed by using the method shown below.

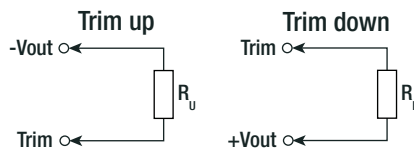

### RP15-xx3.3A

Trim up	1	2	3	4	5	6	7	8	9	10	[%]
Vout =	3.333	3.366	3.399	3.432	3.465	3.498	3.531	3.564	3.597	3.63	[VDC]
R <sub>u</sub> =	385.071	191.511	126.990	94.730	75.374	62.470	53.253	46.340	40.963	36.662	[kΩ]
Trim down	1	2	3	4	5	6	7	8	9	10	[%]
Vout =	3.267	3.234	3.201	3.168	3.135	3.102	3.069	3.036	3.003	2.97	[VDC]
R <sub>d</sub> =	116.719	54.779	34.133	23.810	17.616	13.486	10.537	8.325	6.604	5.228	[kΩ]

continued on next page

**Specifications** (measured @ Ta= 25°C, nom. Vin, full load unless otherwise stated)

<b>RP15-xx05A</b>											
Trim up	1	2	3	4	5	6	7	8	9	10	[%]
Vout =	5.05	5.10	5.15	5.20	5.25	5.30	5.35	5.4	5.45	5.50	[VDC]
R <sub>v</sub> =	253.450	125.700	83.117	61.825	49.050	40.533	34.450	29.888	26.339	23.500	[kΩ]
Trim down	1	2	3	4	5	6	7	8	9	10	[%]
Vout =	4.95	4.90	4.85	4.80	4.75	4.70	4.65	4.60	4.55	4.50	[VDC]
R <sub>v</sub> =	248.340	120.590	78.007	56.715	43.940	35.423	29.340	24.778	21.229	18.390	[kΩ]
<b>RP15-xx12A</b>											
Trim up	1	2	3	4	5	6	7	8	9	10	[%]
Vout =	12.12	12.24	12.36	12.48	12.60	12.72	12.84	12.96	13.08	13.20	[VDC]
R <sub>v</sub> =	203.223	99.057	64.334	46.973	36.557	29.612	24.652	20.932	18.038	15.723	[kΩ]
Trim down	1	2	3	4	5	6	7	8	9	10	[%]
Vout =	11.88	11.76	11.64	11.52	11.40	11.28	11.16	11.04	10.92	10.8	[VDC]
R <sub>v</sub> =	776.557	380.723	248.779	182.807	143.223	116.834	97.985	83.848	72.853	64.057	[kΩ]
<b>RP15-xx15A</b>											
Trim up	1	2	3	4	5	6	7	8	9	10	[%]
Vout =	15.15	15.3	15.45	15.60	15.75	15.90	16.05	16.20	16.35	16.50	[VDC]
R <sub>v</sub> =	161.557	78.223	50.446	36.557	28.223	22.668	18.700	15.723	13.409	11.557	[kΩ]
Trim down	1	2	3	4	5	6	7	8	9	10	[%]
Vout =	14.85	14.70	14.55	14.40	14.25	14.10	13.95	13.80	13.65	13.50	[VDC]
R <sub>v</sub> =	818.223	401.557	262.668	193.223	151.557	123.779	103.938	89.057	77.483	68.223	[kΩ]

<b>REGULATIONS</b>			
Parameter	Condition		Value
Output Accuracy			±1.0%
Line Regulation	low line to high line, full load	Single	±0.2%
		Dual	±0.5%
Load Regulation	0% to 100% load	Single	±0.2%
		Dual	±1.0%
Cross Regulation	asymmetrical 25%<>100% load		±5.0%
Transient Response Recovery Time	25% load step change		250µs typ.

**Specifications** (measured @ Ta= 25°C, nom. Vin, full load unless otherwise stated)

**PROTECTIONS**

Parameter	Condition		Value
Short Circuit Protection (SCP)			continuous, automatic recovery
Over Voltage Protection (OVP)	zener diode clamp	3.3Vout	3.7 - 5.4VDC
		5Vout	5.6 - 7.0VDC
		12Vout	13.5 - 19.6VDC
		15Vout	16.8 - 20.5VDC
Over Load Protection (OLP)	% of lout rated		150% typ., Hiccup mode
Isolation Voltage <sup>(7)</sup>	I/P to O/P		1.6kVDC/ 1 minute
	I/P to O/P to case		1.0kVDC/ 1 minute
Isolation Resistance	Viso= 500VDC		1GΩ min.
Isolation Capacitance			1000pF max.
<p><b>Notes:</b></p> <p>Note7: For repeat Hi-Pot testing, reduce the time and/or the test voltage</p> <p>Note8: This power module is not internally fused. An input line fuse must always be used Recom suggests: 12Vin= T3.15A; 24Vin= T1.6A; 48Vin= T1.25A slow blow types</p>			

**ENVIRONMENTAL**

Parameter	Condition		Value
Operating Temperature Range	without derating		-40°C to +68°C
	with derating		-40°C to +105°C
Maximum Case Temperature			+105°C
Temperature Coefficient			±0.02%/K max.
Thermal Impedance	@ natural convection	without heat-sink	18.2K/W
	0.1m/s	with heat-sink	15.8K/W
Operating Humidity	non-condensing		5% - 95% RH
Thermal Shock			according to MIL-STD-810F
Vibration			according to MIL-STD-810F
MTBF	according to MIL-HDBK-217F, G.B. Bellcore TR-NWT-000332 <sup>(9)</sup>	+25°C	1600 x 10 <sup>3</sup> hours
			1330 x 10 <sup>3</sup> hours

**Derating Graph <sup>(10)</sup>**

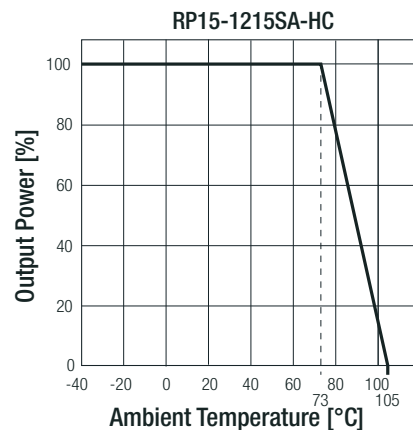
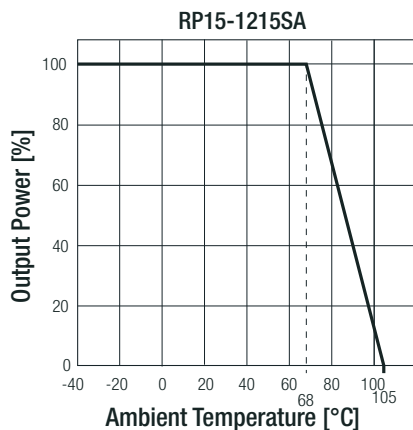

**Notes:**

Note9: BELLCORE TR-NWT-000332. Case I: 50% Stress, Ta= 40°C. MIL-HDBK 217F Notice 2. Ta = 25°C, full load, (controlled environment)

Note10: Derating graphs are valid only for the shown part numbers. If you need detailed derating-information about a part-number not shown here please contact RECOM Techsupport for detailed information

**Specifications** (measured @ Ta= 25°C, nom. Vin, full load unless otherwise stated)

### SAFETY AND CERTIFICATIONS

Certificate Type (Safety)	Condition	Standard
Information Technology Equipment, General Requirements for Safety	E196683	UL60950-1, 1st Edition CAN/CSA-C22.2 No. 60950-1-07, 1st Edition
RoHS 2		RoHS-2011/65/EU + AM-2015/863

EMC Compliance	Condition	Standard / Criterion
Electromagnetic compatibility of multimedia equipment - Emission requirements	with external filter (see filter suggestion below)	EN55032, Class A and B
ESD Electrostatic discharge immunity test	Air ±8kV and Contact ±6kV	EN61000-4-2, Criteria A
Radiated, radio-frequency, electromagnetic field immunity test	10V/m	EN61000-4-3, Criteria A
Fast Transient and Burst Immunity <sup>(1)</sup>	±2kV	EN61000-4-4, Criteria A
Surge Immunity <sup>(1)</sup>	±1kV	EN61000-4-5, Criteria A
Immunity to conducted disturbances, induced by radio-frequency fields	3Vr.m.s	EN61000-4-6, Criteria A
Power Magnetic Field Immunity	100A/m continuous; 1000A/m 1s	EN61000-4-8, Criteria A

#### Notes:

Note11: An external input filter capacitor is required if the module has to meet EN61000-4-4, EN61000-4-5  
Recom suggests Nippon chemi-con KY series 220µF/100V

### EMC Filtering Suggestions according to EN55032

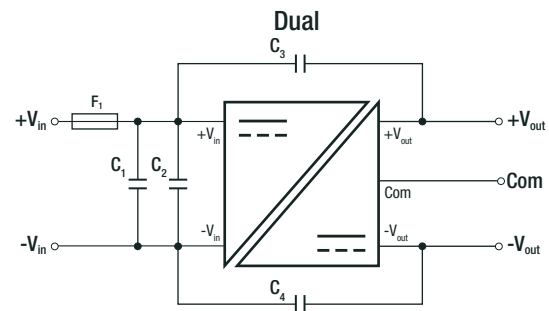
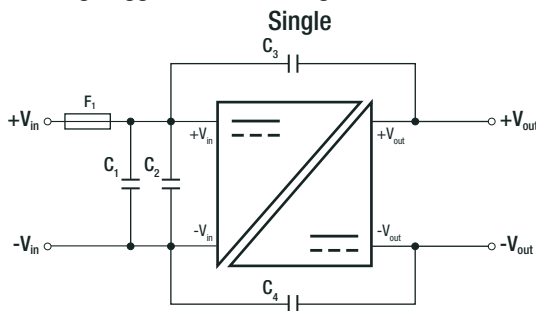

#### Component List Class A

MODEL	C1	C2	C3/C4
RP15-12xxSA, RP15-12xxDA	10µF/25V, 1812 MLCC	N/A	470pF/2kV, 1808 MLCC
RP15-24xxSA, RP15-24xxDA	6.8µF/50V, 1812 MLCC	6.8µF/50V, 1812 MLCC	470pF/2kV, 1808 MLCC
RP15-48xxSA, RP15-48xxDA	2.2µF/100V, 1812 MLCC	2.2µF/100V, 1812 MLCC	470pF/2kV, 1808 MLCC

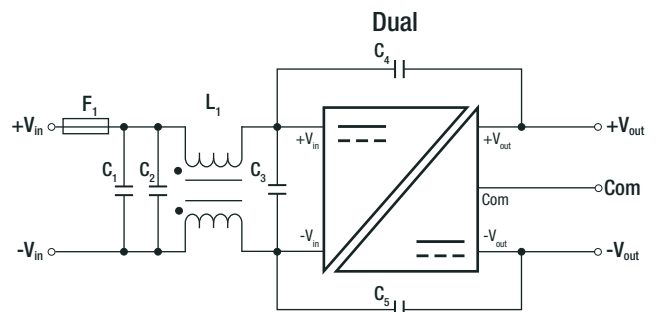
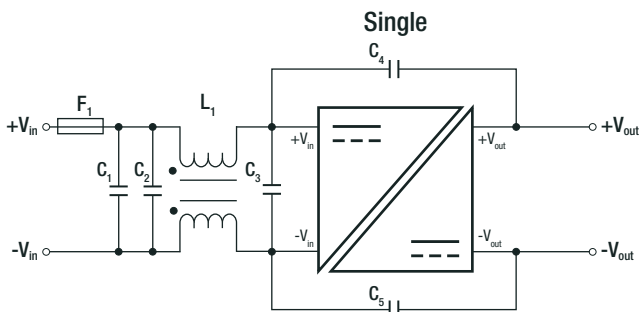

#### Component List Class B

MODEL	C1	C2	C3	C4/C5	L1
RP15-12xxSA, RP15-12xxDA	10µF/25V 1812 MLCC	N/A	10µF/25V 1812 MLCC	470pF/2kV 1808 MLCC	CMC: 145µH ref: WE 482210002 ref: CMC-07
RP15-24xxSA, RP15-24xxDA	6.8µF/50V 1812 MLCC	N/A	6.8µF/50V 1812 MLCC	470pF/2kV 1808 MLCC	CMC: 325µH ref: WE 744290321 ref: CMC-06
RP15-48xxSA, RP15-48xxDA	2.2µF/100V 1812 MLCC	2.2µF/100V 1812 MLCC	2.2µF/100V 1812 MLCC	470pF/2kV 1808 MLCC	CMC: 325µH ref: WE 744290321 ref: CMC-06

**Specifications** (measured @ Ta= 25°C, nom. Vin, full load unless otherwise stated)

Parameter	Type	Value
Material	case	nickel coated copper
	base	FR4 PCB
	potting	epoxy (UL94V-0)
Dimensions (LxWxH)	without Heat-sink	25.4 x 25.4 x 9.9mm
	with Heat-sink	31.4 x 25.4 x 16.5mm
Weight	without Heat-sink	15g
	with Heat-sink	21.5g

Dimension Drawing (mm)

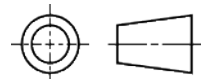
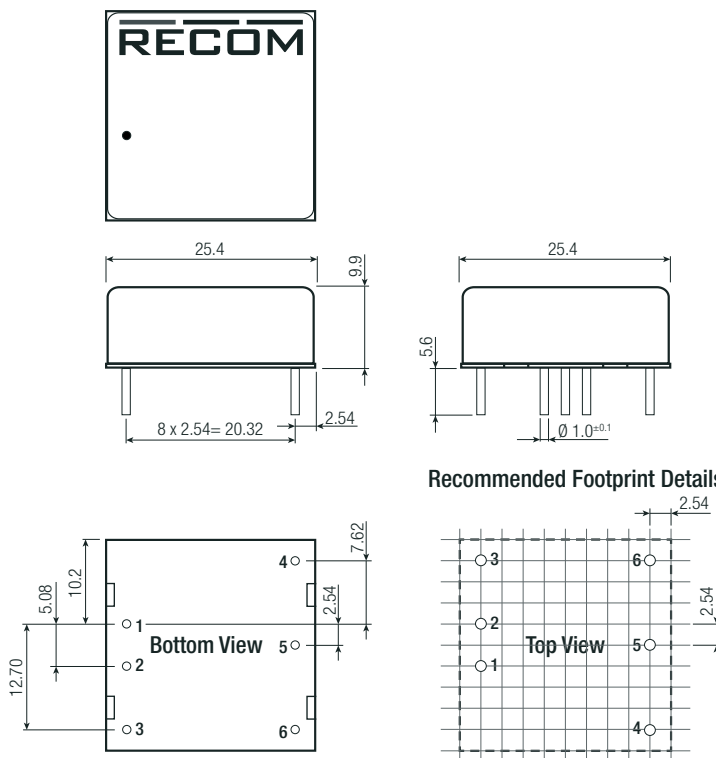

Pinning Information

Pin #	Single	Dual
1	+Vin	+Vin
2	-Vin	-Vin
3	CTRL <sup>(3)</sup>	CTRL <sup>(3)</sup>
4	+Vout	+Vout
5	Trim	Com
6	-Vout	-Vout

Pin Pitch Tolerance ±0.25mm  
Tolerance: xx.x= ±0.5mm  
xx.xx= ±0.25mm

Dimension Drawing with Heat-sink (mm)

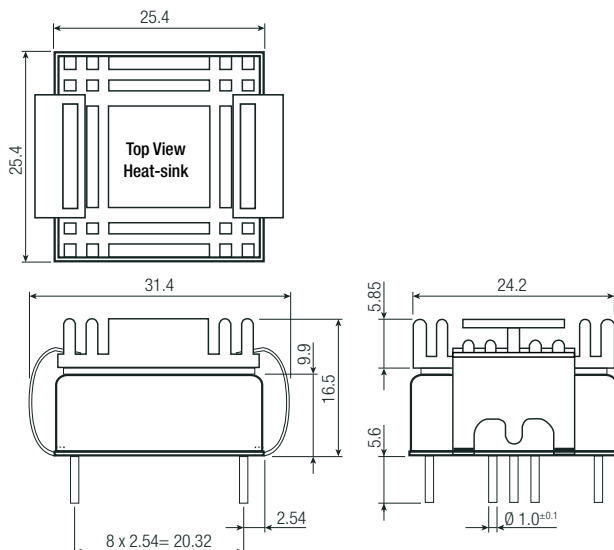

**Specifications** (measured @ Ta= 25°C, nom. Vin, full load unless otherwise stated)

PACKAGING INFORMATION			
Parameter	Type		Value
Packaging Dimension (LxWxH)	tube	without heat-sink	257.0 x 28.5 x 21.0mm
	tray	with heat-sink	230.0 x 180.0 x 28.0mm
Packaging Quantity	tube	without heat-sink	8pcs
	tray	with heat-sink	20pcs
Storage Temperature Range			-55°C to +125°C
Storage Humidity	non-condensing		5% - 95% RH

The product information and specifications may be subject to changes even without prior written notice. The product has been designed for various applications; its suitability lies in the responsibility of each customer. The products are not authorized for use in safety-critical applications without RECOM's explicit written consent. A safety-critical application is an application where a failure may reasonably be expected to endanger or cause loss of life, inflict bodily harm or damage property. The applicant shall indemnify and hold harmless RECOM, its affiliated companies and its representatives against any damage claims in connection with the unauthorized use of RECOM products in such safety-critical applications.