

## General information

Part number	S11YDR-P16XCD0-0000
Termination	solder
Size	1
Locking principle	push
Coding	d_key_amc
Cable Diameter	cable_amc_1
Cable outlet	overmolding

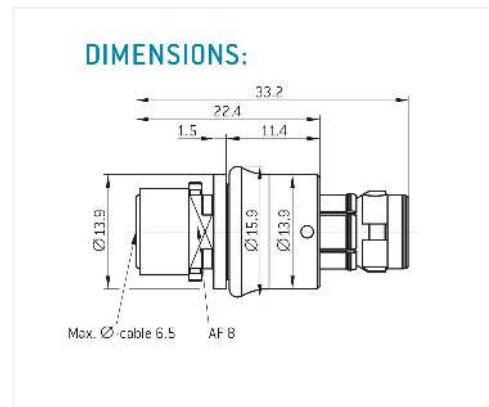
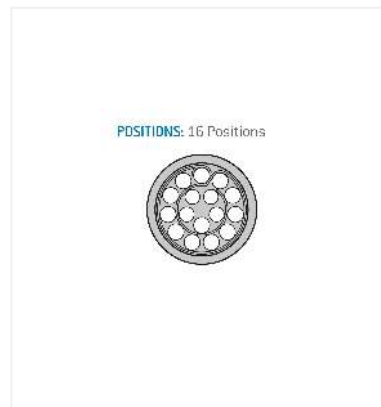
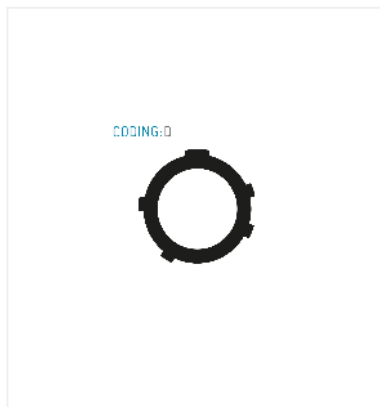

## Contact insert description

Number of contacts	16
Contact type	pins
Contact diameter	05mm
Insulator material	peek
Wire cross section	26_awg
Termination	solder
Termination diameter	065mm

reverse\_gender\_on\_request

## Technical information

Nominal current single contact	05_a	iec_60512_5_2
Nominal current insert	2,5 A	vde_0298_4
Test voltage	06_kv_ac	eia_364_20f

safety\_text

## Mechanical and environmental data

Degree of protection*	ipsk8_ip6k9k
Operating temperature	51_125_c
Mating cycles	5000

mated

## Material and surface treatments

Housing	ruthenium
Contact	cu_alloy_gold

safety\_text\_2  
ul\_text  
illustrative\_text