

# PQ015YZ5MZ Series/PQ015YZ01Z Series

Low Voltage Operation, Low Power-Loss Voltage Regulators (SC-63 Package)

## ■ Features

- Low voltage operation (Minimum operating voltage: 1.7V)  
1.8V input → available 1.0 to 1.5V output
- Variable output voltage type
- Surface mount package (equivalent to EIAJ SC-63)

## ■ Applications

- Personal computers, power supply in peripherals
- Power supplies for various electronic equipment such as DVD player or STB

## ■ Model Line-up

Output current (I <sub>o</sub> )	Package type	Variable output
0.5A	Taping	<b>PQ015YZ5MZP</b>
	Sleeve	<b>PQ015YZ5MZZ</b>
1A	Taping	<b>PQ015YZ01ZP</b>
	Sleeve	<b>PQ015YZ01ZZ</b>

## ■ Outline Dimensions

(Unit : mm)

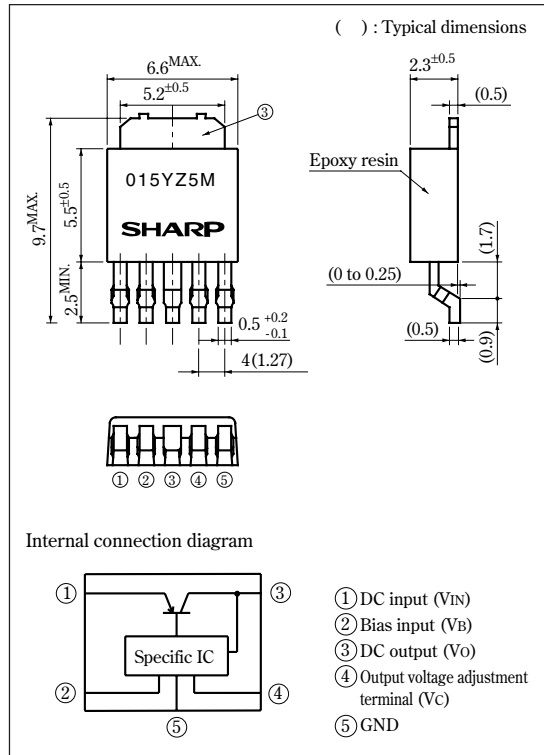

## ■ Absolute Maximum Ratings

(T<sub>a</sub>=25°C)

Parameter	Symbol	Rating	Unit
*1 Input voltage	V <sub>IN</sub>	3.7	V
Bias supply voltage	V <sub>B</sub>	7	V
*1 Output adjustment terminal voltage	V <sub>ADJ</sub>	5	V
Output current	<b>PQ015YZ5MZ series</b>	0.5	A
	<b>PQ015YZ01Z series</b>	1	
*2 Power dissipation (with infinite heat sink)	P <sub>D</sub>	8	W
*3 Junction temperature	T <sub>J</sub>	150	°C
Operating temperature	T <sub>opr</sub>	-25 to +85	°C
Storage temperature	T <sub>stg</sub>	-40 to +150	°C
Soldering temperature	T <sub>sol</sub>	260 (10s)	°C

\*1 All are open except GND and applicable terminals

\*2 P<sub>D</sub>:With infinite heat sink

\*3 Overheat protection may operate at T<sub>J</sub>=125°C to 150°C

•Please refer to the chapter " Handling Precautions ".

**SHARP**

■ Electrical Characteristics

(Unless otherwise specified, condition shall be (PQ015YZ5MZ))

(Unless otherwise specified, condition shall be (PQ015YZ01Z))

Parameter	Symbol	Conditions	MIN.	TYP.	MAX.	Unit
Input voltage	V <sub>IN</sub>	On condition that 1.0V ≤ V <sub>o</sub> ≤ 1.2V	1.7	-	3.7	V
		On condition that 1.2V ≤ V <sub>o</sub> ≤ 1.5V	V <sub>o</sub> +0.5	-	3.7	
Bias supply voltage	V <sub>B</sub>	-	2.35	-	7	V
Output voltage	V <sub>o</sub>	-	1.0	-	1.5	V
Load regulation	R <sub>regL</sub>	I <sub>o</sub> =5mA to 0.5A	-	0.2	1	%
		I <sub>o</sub> =5mA to 1A	-	0.2	1	
Line regulation	R <sub>regI</sub>	V <sub>IN</sub> =1.7 to 3.7V, V <sub>B</sub> =2.35 to 7V, I <sub>o</sub> =5mA	-	0.2	1	%
Ripple Rejection	RR <sub>1</sub>	Refer to Fig.2	-	65	-	dB
	RR <sub>2</sub>	Refer to Fig.3	-	60	-	dB
Reference voltage	V <sub>REF</sub>	-	0.97	1	1.03	V
Temperature coefficient of reference voltage	T <sub>c</sub> V <sub>REF</sub>	T <sub>j</sub> =0 to 125°C, I <sub>o</sub> =5mA	-	±0.5	-	%
Bias inflow current	I <sub>B</sub>	-	-	1.5	3	mA

Fig.1 Test Circuit

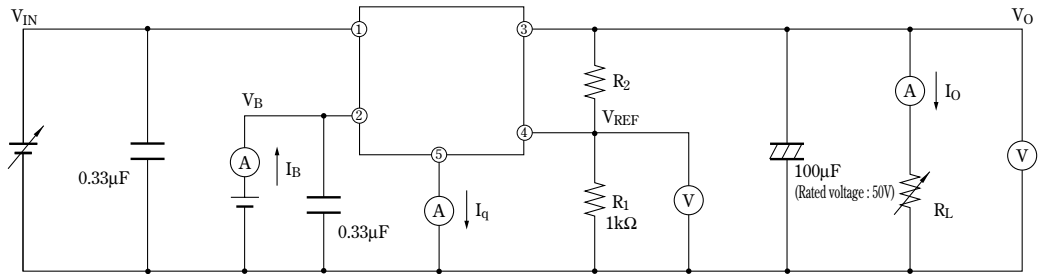

Fig.2 Test Circuit for Ripple Rejection (1)

$$V_o = V_{REF} \times (1 + R_2/R_1)$$

$$[R_1 = 1k\Omega, V_{REF} \approx 1.0V]$$

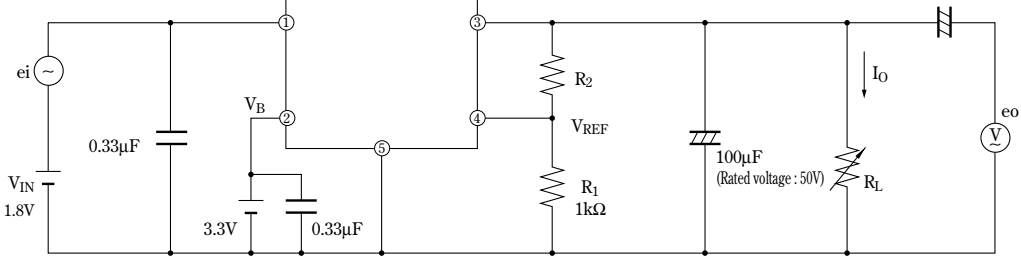
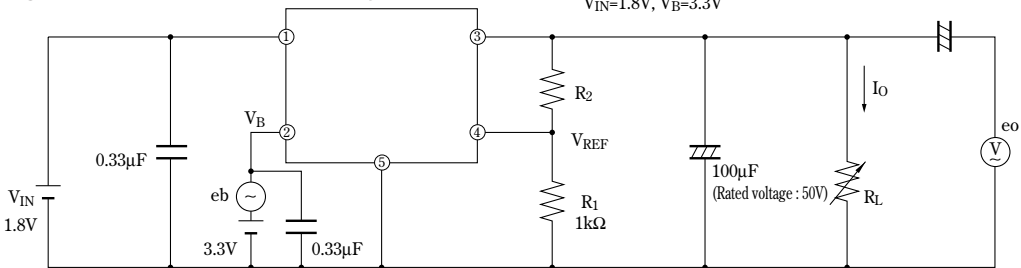

Fig.3 Test Circuit for Ripple Rejection (2)

f=120Hz (sine wave)  
e<sub>i</sub>(rms)=0.1V  
V<sub>IN</sub>=1.8V, V<sub>B</sub>=3.3V  
I<sub>o</sub>=0.3A  
RR=20log(e<sub>i</sub>(rms)/e<sub>o</sub>(rms))



f=120Hz (sine wave)  
e<sub>b</sub>(rms)=0.1V  
V<sub>IN</sub>=1.8V, V<sub>B</sub>=3.3V  
I<sub>o</sub>=0.3A  
RR=20log(e<sub>b</sub>(rms)/e<sub>o</sub>(rms))

**Fig.4 Power Dissipation vs. Ambient Temperature**

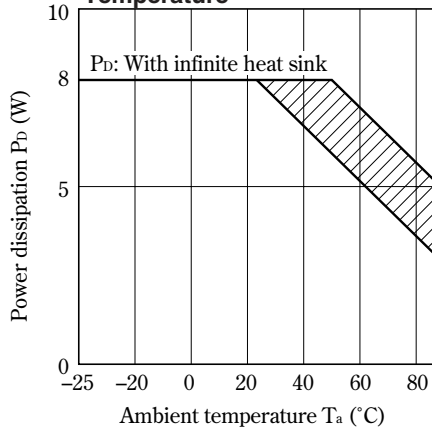

Note) Oblique line portion: Overheat protection may operate in this area.

**Fig.6 Overcurrent Protection Characteristics**

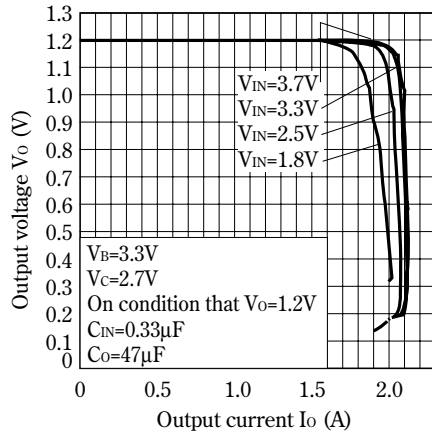

**Fig.5 Overcurrent Protection Characteristics (PQ015YZ5MZ)**

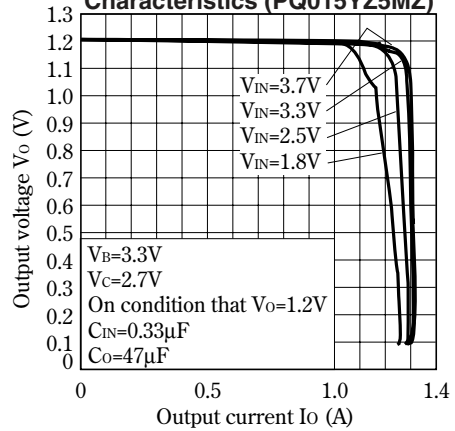

**Fig.7 Reference Voltage vs. Ambient Temperature**

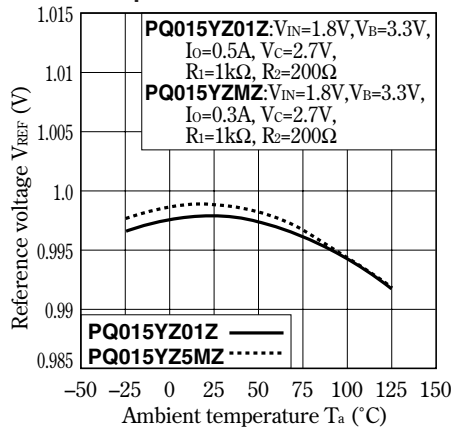

**Fig.8 Bias Inflow Current vs. Ambient Temperature**

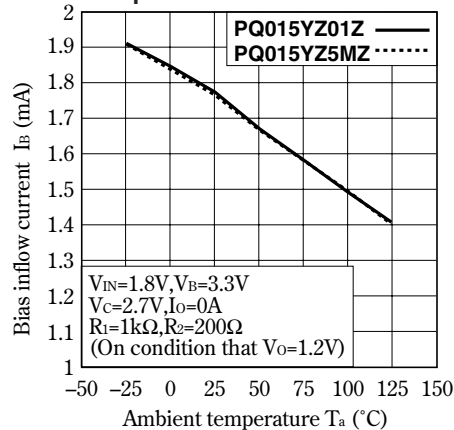

**Fig.9 Output Short circuit Current vs. Ambient Temperature**

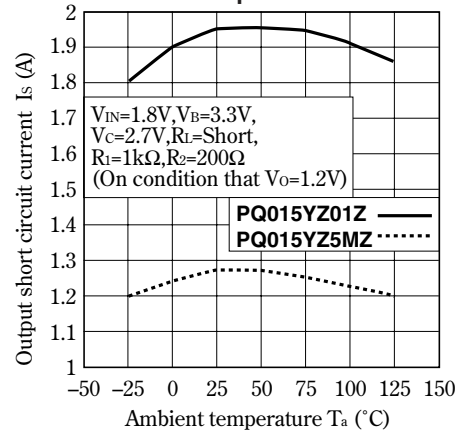

**Fig.10 Output Voltage vs. Input Voltage (PQ015YZ5MZ)**

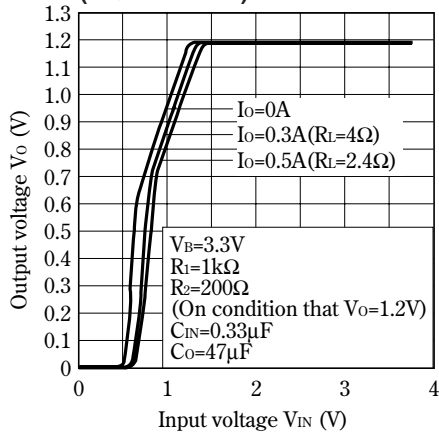

**Fig.11 Output Voltage vs. Input Voltage (PQ015YZ01Z)**

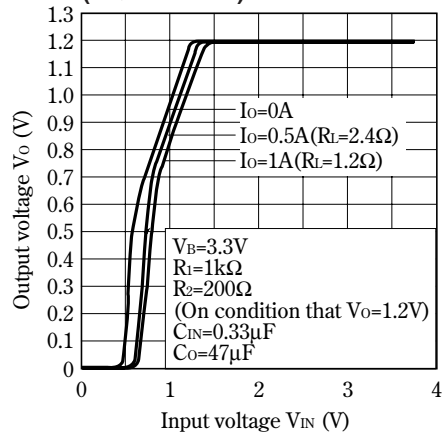

**Fig.12 Output Voltage vs. Bias Supply Voltage (PQ015YZ5MZ)**

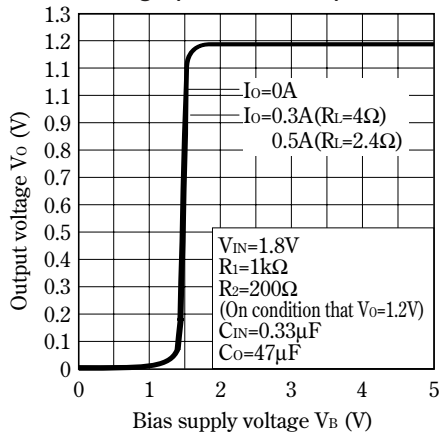

**Fig.13 Output Voltage vs. Bias Supply Voltage (PQ015YZ01Z)**

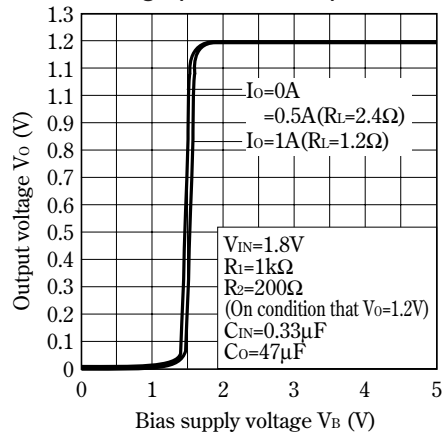

**Fig.14 Circuit Operating Current vs. Input Voltage /Bias Supply Voltage (PQ015YZ5MZ)**

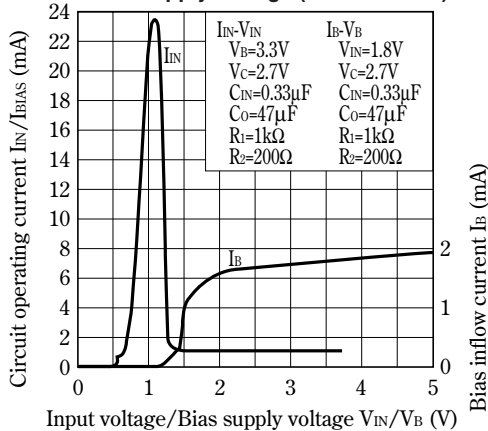

**Fig.15 Circuit Operating Current vs. Input Voltage /Bias Supply Voltage (PQ015YZ01Z)**

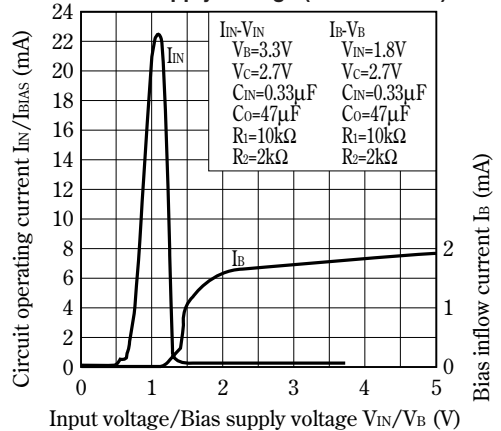

**Fig.16 Circuit Operating Current vs. Input Voltage /Bias Supply Voltage (PQ015YZ01Z)**

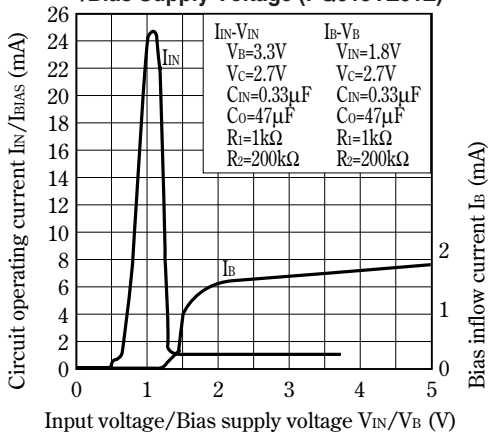

**Fig.17 Circuit Operating Current vs. Input Voltage /Bias Supply Voltage (PQ015YZ5MZ)**

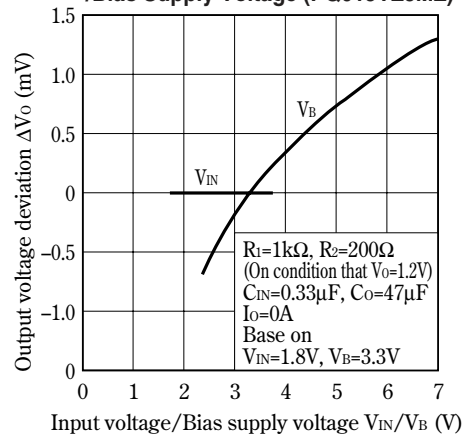

**Fig.18 Output Voltage vs. Input Voltage/Bias Supply Voltage (PQ015YZ01Z)**

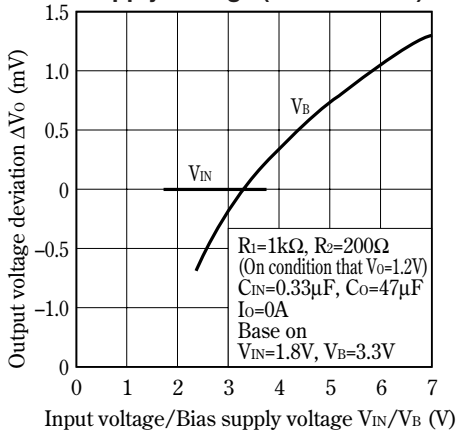

**Fig.19 Output Voltage vs. Output Current**

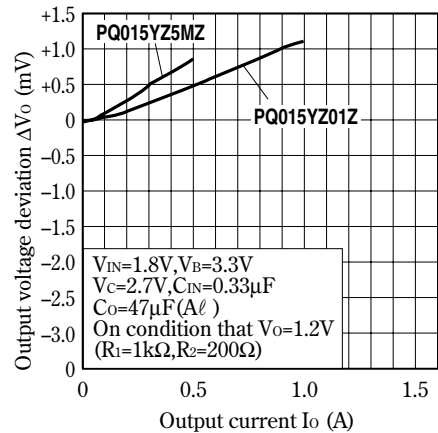

**Fig.20 Ripple Rejection vs. Input Ripple Frequency**

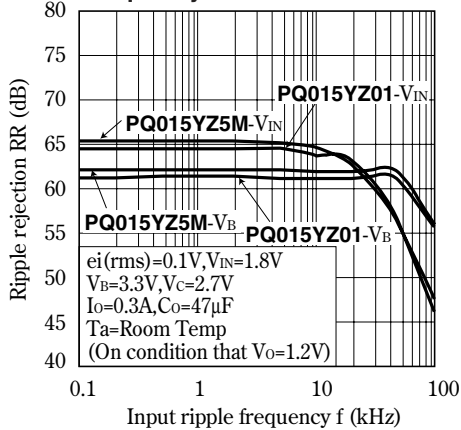

**Fig.21 Ripple Rejection vs. Output Current**

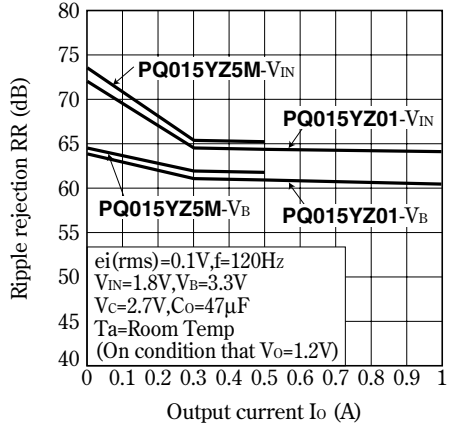

Fig.22 Typical Application

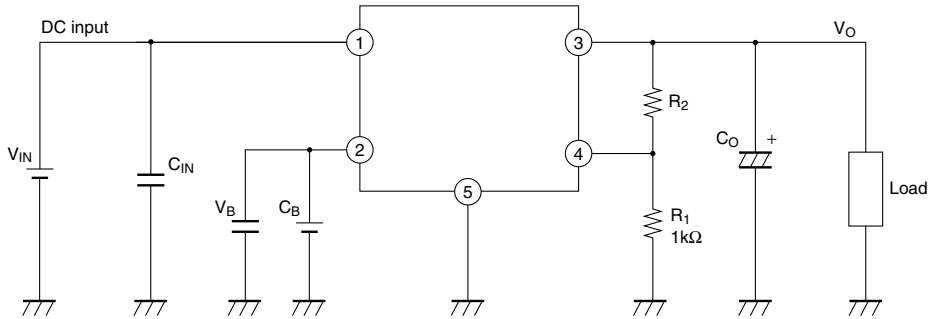
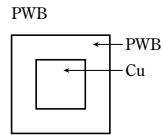
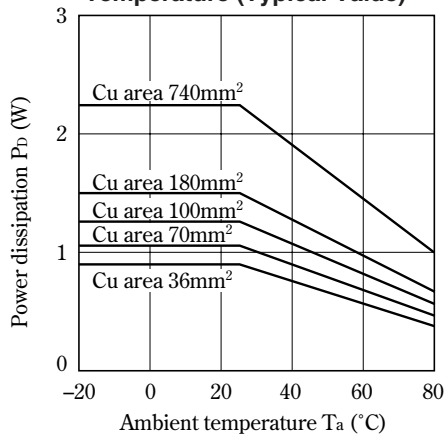
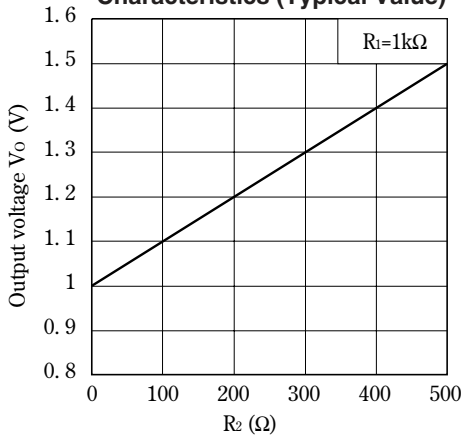

Fig.23 Power Dissipation vs. Ambient Temperature (Typical Value)



Material : Glass-cloth epoxy resin  
 Size : 50×50×1.6mm  
 Cu thickness : 35μm

Fig.24 Output Voltage Adjustment Characteristics (Typical Value)



### ■ Setting of Output Voltage

Output voltage is able to set from 1.0V to 1.5V when resistors  $R_1$  and  $R_2$  are attached to ③, ④, ⑤ terminals. As for the external resistors to set output voltage, refer to the figure below and Fig.24.

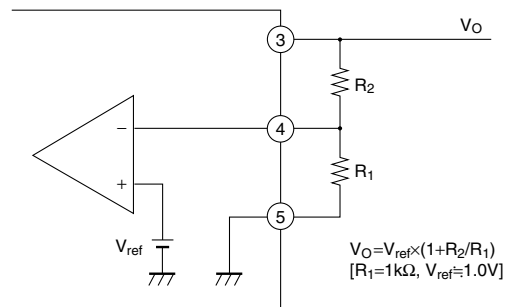

## NOTICE

- The circuit application examples in this publication are provided to explain representative applications of SHARP devices and are not intended to guarantee any circuit design or license any intellectual property rights. SHARP takes no responsibility for any problems related to any intellectual property right of a third party resulting from the use of SHARP's devices.
- Contact SHARP in order to obtain the latest device specification sheets before using any SHARP device. SHARP reserves the right to make changes in the specifications, characteristics, data, materials, structure, and other contents described herein at any time without notice in order to improve design or reliability. Manufacturing locations are also subject to change without notice.
- Observe the following points when using any devices in this publication. SHARP takes no responsibility for damage caused by improper use of the devices which does not meet the conditions and absolute maximum ratings to be used specified in the relevant specification sheet nor meet the following conditions:
  - (i) The devices in this publication are designed for use in general electronic equipment designs such as:
    - Personal computers
    - Office automation equipment
    - Telecommunication equipment [terminal]
    - Test and measurement equipment
    - Industrial control
    - Audio visual equipment
    - Consumer electronics
  - (ii) Measures such as fail-safe function and redundant design should be taken to ensure reliability and safety when SHARP devices are used for or in connection with equipment that requires higher reliability such as:
    - Transportation control and safety equipment (i.e., aircraft, trains, automobiles, etc.)
    - Traffic signals
    - Gas leakage sensor breakers
    - Alarm equipment
    - Various safety devices, etc.
  - (iii) SHARP devices shall not be used for or in connection with equipment that requires an extremely high level of reliability and safety such as:
    - Space applications
    - Telecommunication equipment [trunk lines]
    - Nuclear power control equipment
    - Medical and other life support equipment (e.g., scuba).
- If the SHARP devices listed in this publication fall within the scope of strategic products described in the Foreign Exchange and Foreign Trade Law of Japan, it is necessary to obtain approval to export such SHARP devices.
- This publication is the proprietary product of SHARP and is copyrighted, with all rights reserved. Under the copyright laws, no part of this publication may be reproduced or transmitted in any form or by any means, electronic or mechanical, for any purpose, in whole or in part, without the express written permission of SHARP. Express written permission is also required before any use of this publication may be made by a third party.
- Contact and consult with a SHARP representative if there are any questions about the contents of this publication.