

Switching Diode

■ FEATURES

Two elements

Small Package

Environmentally Friendly : EU RoHS Compliant, Pb Free

■ PRODUCT NAME

| PRODUCT NAME | PACKAGE | ORDER UNIT |
|----------------|---------|------------|
| XBW21P0204-G * | SOT-323 | 3,000/Reel |

* The "-G" suffix denotes Halogen and Antimony free as well as being fully EU RoHS compliant.

■ PIN CONFIGURATION

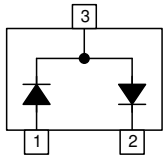

■ ABSOLUTE MAXIMUM RATINGS

Ta=25°C

| PARAMETER | SYMBOL | RATINGS | UNIT |
|---|-------------|-------------|------|
| Reverse Voltage (DC) | V_R | 75 | V |
| Peak Reverse Voltage | V_{RM} | 100 | V |
| Forward Current (Average) | $I_{F(AV)}$ | 150 | mA |
| Peak Forward Surge Current ($t=1 \mu s$) | I_{FSM} | 4 | A |
| Power Dissipation | P_d | 200 | mW |
| Junction Temperature | T_j | 150 | °C |
| Storage Temperature | T_{stg} | -55 to +150 | °C |

■ ELECTRICAL CHARACTERISTICS

Ta=25°C

| PARAMETER | SYMBOL | TEST CONDITIONS | LIMITS | | | UNITS |
|-----------------------|----------|--|--------|------|-------|---------|
| | | | MIN. | TYP. | MAX. | |
| Forward Voltage | V_{F1} | $I_F=10mA$ | - | - | 0.855 | V |
| | V_{F2} | $I_F=50mA$ | - | - | 1.00 | V |
| | V_{F3} | $I_F=150mA$ | - | - | 1.25 | V |
| Reverse Current | I_R | $V_R=25V$ | - | - | 0.03 | μA |
| Terminal Capacitance | C_t | $V_R=0V, f=1MHz$ | - | - | 1.5 | pF |
| Reverse Recovery Time | t_{rr} | $I_F=I_R=10mA, i_{rr}=1mA, R_L=100 \Omega$ | - | 4 | - | ns |

■ APPLICATIONS

- High-speed Switching

■ PACKAGING INFORMATION

- SOT-323

Unit : inch (mm)

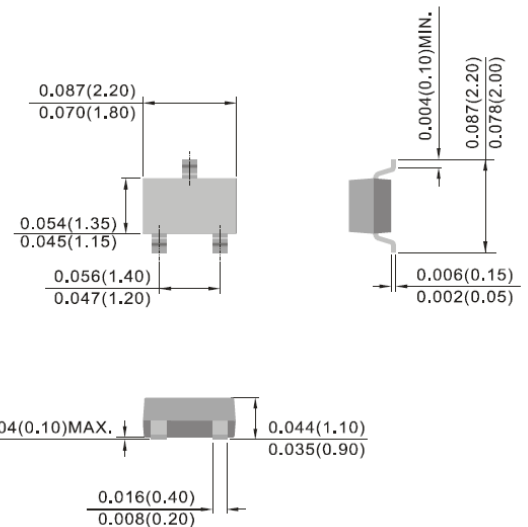

MEASUREMENT CIRCUITS

Reverse Recovery Time

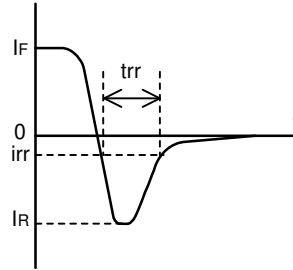
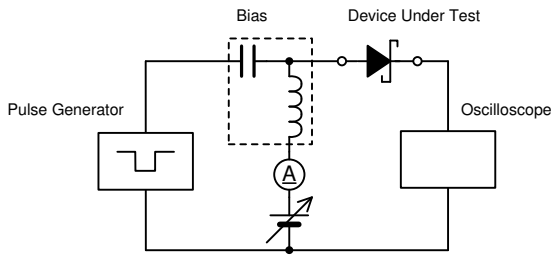

NOTES ON USE

1. Please use this IC within the absolute maximum ratings.

Even within the ratings, in case of high load use continuously such as high temperature, high voltage, high current and thermal stress may cause reliability degradation of the IC.

2. Torex places an importance on improving our products and their reliability.

We request that users incorporate fail-safe designs and post-aging protection treatment when using Torex products in their systems.

■ TYPICAL PERFORMANCE CHARACTERISTICS

(1) Forward Current vs. Forward Voltage

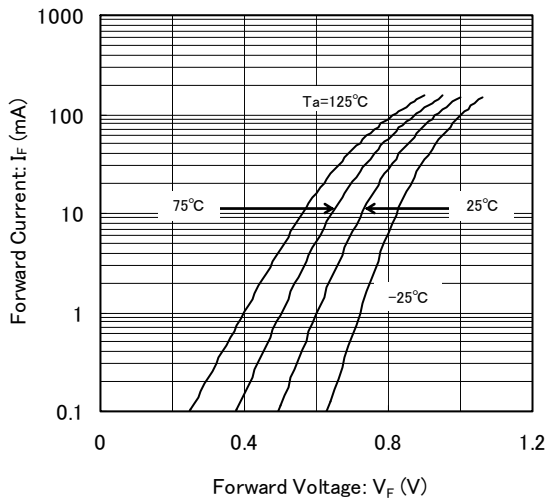

(2) Reverse Current vs. Reverse Voltage

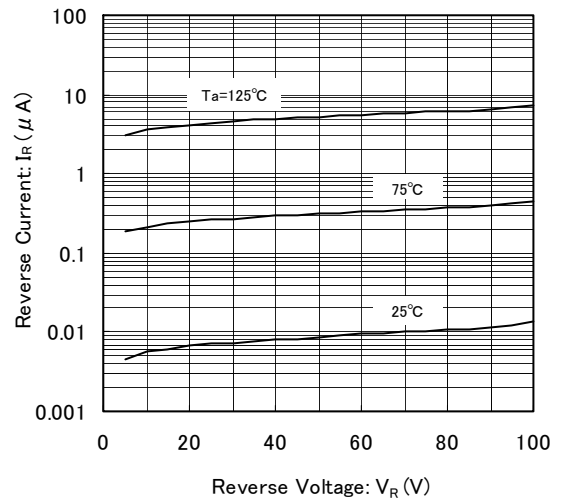

(3) Terminal Capacitance vs. Reverse Voltage

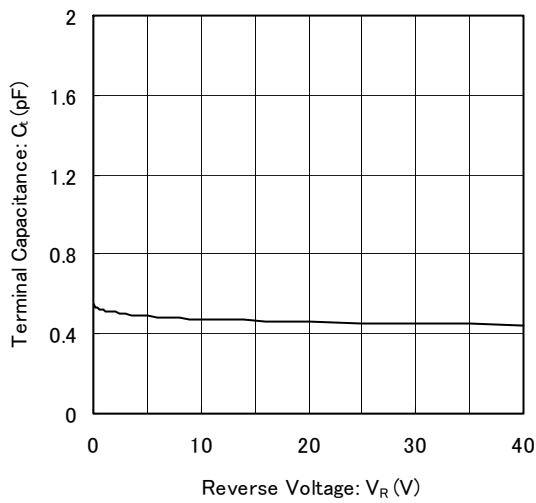

(4) Power Dissipation vs. Operating Temperature

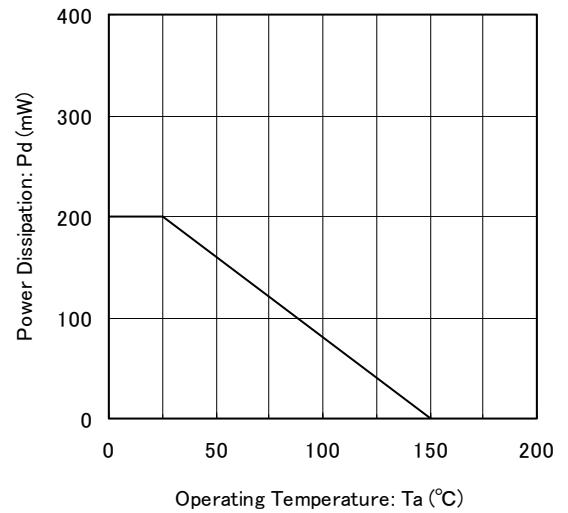

REFERENCE PATTERN LAYOUT

●SOT-323

Unit : inch (mm)

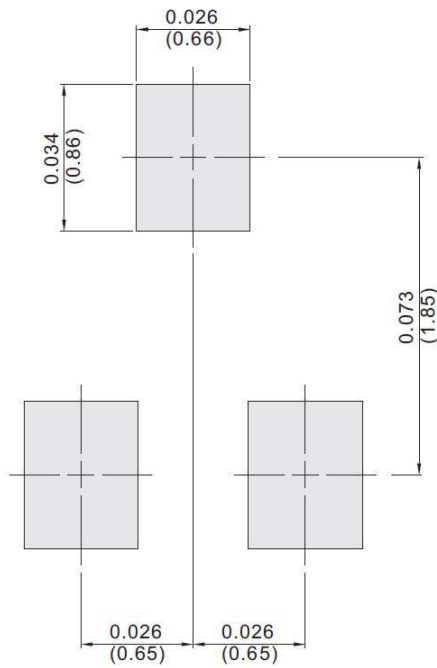

MARKING

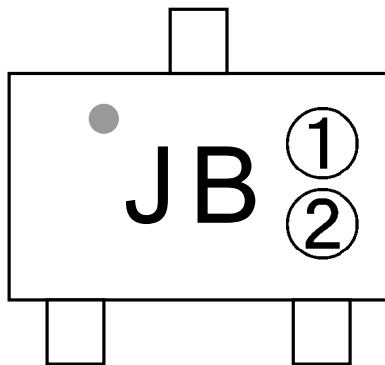

①② : Control Number

TAPING SPECIFICATIONS

●SOT-323

Unit : mm

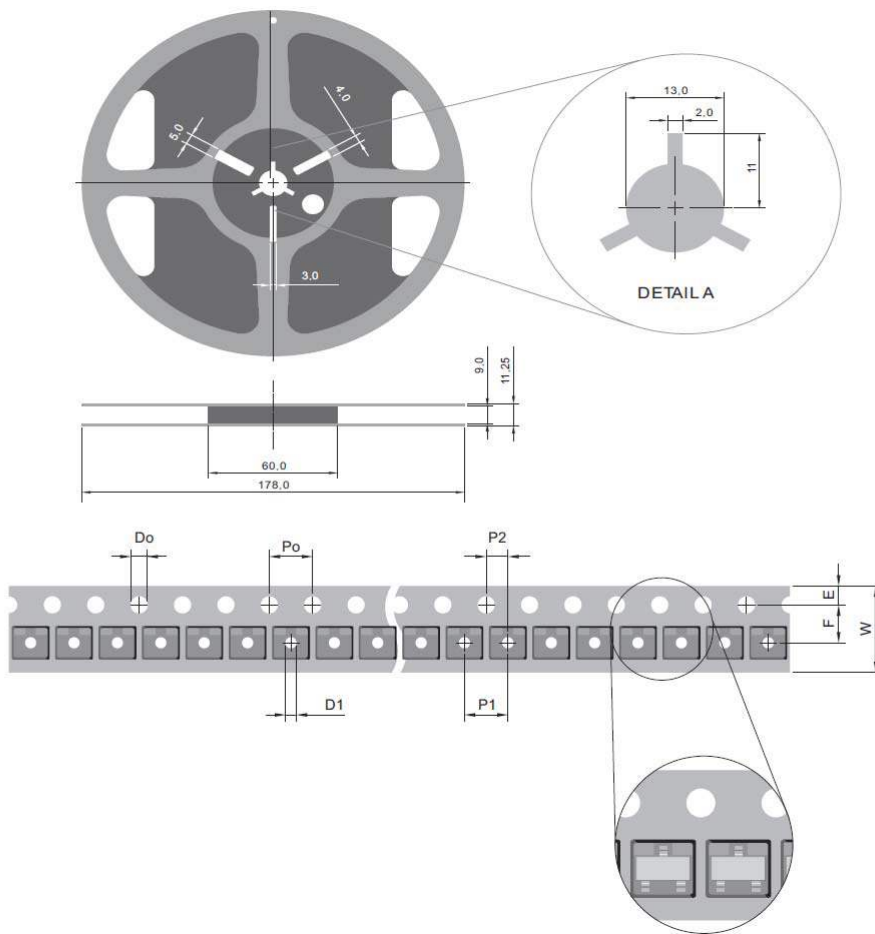

| SYMBOL | mm |
|--------|--|
| D_0 | 1.55 ± 0.05 |
| D_1 | 1.00 ± 0.25 |
| E | 1.75 ± 0.10 |
| F | 3.50 ± 0.05 |
| P_0 | 4.00 ± 0.10 |
| P_1 | 4.00 ± 0.10 |
| P_2 | 2.00 ± 0.05 |
| W | $8.00 \begin{matrix} +0.3 \\ -0.15 \end{matrix}$ |

1. The products and product specifications contained herein are subject to change without notice to improve performance characteristics. Consult us, or our representatives before use, to confirm that the information in this datasheet is up to date.
2. We assume no responsibility for any infringement of patents, patent rights, or other rights arising from the use of any information and circuitry in this datasheet.
3. Please ensure suitable shipping controls (including fail-safe designs and aging protection) are in force for equipment employing products listed in this datasheet.
4. The products in this datasheet are not developed, designed, or approved for use with such equipment whose failure or malfunction can be reasonably expected to directly endanger the life of, or cause significant injury to, the user.
(e.g. Atomic energy; aerospace; transport; combustion and associated safety equipment thereof.)
5. Please use the products listed in this datasheet within the specified ranges.
Should you wish to use the products under conditions exceeding the specifications, please consult us or our representatives.
6. We assume no responsibility for damage or loss due to abnormal use.
7. All rights reserved. No part of this datasheet may be copied or reproduced without the prior permission of TOREX SEMICONDUCTOR LTD.

TOREX SEMICONDUCTOR LTD.