

Features

- Single (EL2170C), dual (EL2270C) and quad (EL2470C) topologies
- 1 mA supply current (per amplifier)
- 70 MHz -3 dB bandwidth
- Tiny SOT23-5 Package (EL2170C)
- Low cost
- Single- and dual-supply operation down to $\pm 1.5V$
- 0.15%/0.15° diff. gain/diff. phase into 150 Ω
- 800 V/ μs slew rate
- Large output drive current:
 - 100 mA (EL2170C)
 - 55 mA (EL2270C)
 - 55 mA (EL2470C)
- Also available with disable in single (EL2176C) and dual (EL2276C)
- Higher speed EL2180C/EL2186C family also available (3 mA/250 MHz) in single, dual and quad

Applications

- Low power/battery applications
- HDSL amplifiers
- Video amplifiers
- Cable drivers
- RGB amplifiers
- Test equipment amplifiers
- Current to voltage converters

Ordering Information

Part No.	Temp. Range	Package	Outline #
EL2170CN	-40°C to +85°C	8-Pin PDIP	MDP0031
EL2170CS	-40°C to +85°C	8-Pin SOIC	MDP0027
EL2170CW	-40°C to +85°C	5-Pin SOT23*	MDP0038
EL2270CN	-40°C to +85°C	8-Pin PDIP	MDP0031
EL2270CS	-40°C to +85°C	8-Pin SOIC	MDP0027
EL2470CN	-40°C to +85°C	14-Pin PDIP	MDP0031
EL2470CS	-40°C to +85°C	14-Pin SOIC	MDP0027

*See Ordering Information section of databook.

General Description

The EL2170C/EL2270C/EL2470C are single/dual/quad current-feedback operational amplifiers which achieve a -3 dB bandwidth of 70 MHz at a gain of +1 while consuming only 1 mA of supply current per amplifier. They will operate with dual supplies ranging from $\pm 1.5V$ to $\pm 6V$, or from single supplies ranging from +3V to +12V. In spite of their low supply current, the EL2270C and the EL2470C can output 55 mA while swinging to $\pm 4V$ on $\pm 5V$ supplies. The EL2170C can output 100 mA with similar output swings. These attributes make the EL2170C/EL2270C/EL2470C excellent choices for low power and/or low voltage cable-driver, HDSL, or RGB applications.

For applications where board space is extremely critical, the EL2170C is available in the tiny 5-Lead SOT23 package, which has a footprint 28% the size of an 8-Lead SOIC. The EL2170C/EL2270C/EL2470C are each also available in industry standard pinouts in PDIP and SOIC packages.

For Single and Dual applications with disable, consider the EL2176C (8-Pin Single) or EL2276C (14-Pin Dual). For higher speed applications where power is still a concern, consider the EL2180C/EL2186C family which also comes in similar Single, Dual, Triple and Quad configurations. The EL2180C/EL2186C family provides a -3 dB bandwidth of 250 MHz while consuming 3 mA of supply current per amplifier.

Connection Diagrams

EL2170C SO, P-DIP

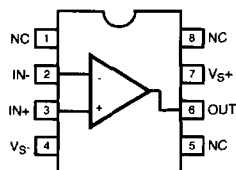

EL2270C SO, P-DIP

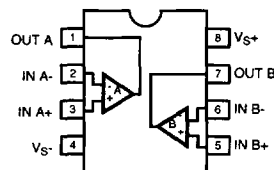

2170-1

EL2170C SOT23-5

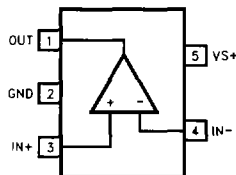

Top View

2170-46

EL2470C SO, P-DIP

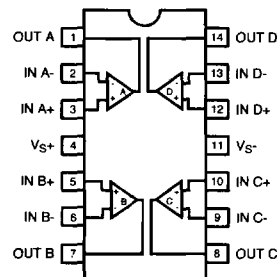

2170-2

EL2170C/EL2270C/EL2470C

70 MHz/1 mA Current Mode Feedback Amplifiers

Absolute Maximum Ratings ($T_A = 25^\circ\text{C}$)

Voltage between V_{S+} and V_{S-}	+12.6V	Operating Junction Temperature	
Common-Mode Input Voltage	V_{S-} to V_{S+}	Plastic Packages	150°C
Differential Input Voltage	$\pm 6\text{V}$	Output Current (EL2170C)	$\pm 120\text{ mA}$
Current into +IN or -IN	$\pm 7.5\text{ mA}$	Output Current (EL2270C)	$\pm 60\text{ mA}$
Internal Power Dissipation	See Curves	Output Current (EL2470C)	$\pm 60\text{ mA}$
Operating Ambient Temperature Range	-40°C to $+85^\circ\text{C}$	Storage Temperature Range	-65°C to $+150^\circ\text{C}$

Important Note:

All parameters having Min/Max specifications are guaranteed. The Test Level column indicates the specific device testing actually performed during production and Quality Inspection. Elantec performs most electrical tests using modern high-speed automatic test equipment, specifically the LTX77 Series system. Unless otherwise noted, all tests are pulsed tests, therefore $T_J = T_C = T_A$.

Test Level	Test Procedure
I	100% production tested and QA sample tested per QA test plan QCX0002.
II	100% production tested at $T_A = 25^\circ\text{C}$ and QA sample tested at $T_A = 25^\circ\text{C}$, T_{MAX} and T_{MIN} per QA test plan QCX0002.
III	QA sample tested per QA test plan QCX0002.
IV	Parameter is guaranteed (but not tested) by Design and Characterization Data.
V	Parameter is typical value at $T_A = 25^\circ\text{C}$ for information purposes only.

DC Electrical Characteristics $V_S = \pm 5\text{V}$, $R_L = 150\Omega$, $T_A = 25^\circ\text{C}$ unless otherwise specified

Parameter	Description	Conditions	Min	Typ	Max	Test Level	Units
V_{OS}	Input Offset Voltage			2.5	15	I	mV
TCV_{OS}	Average Input Offset Voltage Drift	Measured from T_{MIN} to T_{MAX}		5		V	$\mu\text{V}/^\circ\text{C}$
dV_{OS}	V_{OS} Matching	EL2270C, EL2470C only		0.5		V	mV
+ I_{IN}	+ Input Current			0.5	5	I	μA
d+ I_{IN}	+ I_{IN} Matching	EL2270C, EL2470C only		20		V	nA
- I_{IN}	- Input Current			4	15	I	μA
d- I_{IN}	- I_{IN} Matching	EL2270C, EL2470C only		1.5		V	μA
CMRR	Common Mode Rejection Ratio	$V_{CM} = \pm 3.5\text{V}$	45	50		I	dB
-ICMR	- Input Current Common Mode Rejection	$V_{CM} = \pm 3.5\text{V}$		4	10	I	$\mu\text{A}/\text{V}$
PSRR	Power Supply Rejection Ratio	V_S is moved from $\pm 4\text{V}$ to $\pm 6\text{V}$	60	70		I	dB
-IPSR	- Input Current Power Supply Rejection	V_S is moved from $\pm 4\text{V}$ to $\pm 6\text{V}$		0.5	5	I	$\mu\text{A}/\text{V}$
R_{OL}	Transimpedance	$V_{OUT} = \pm 2.5\text{V}$	150	400		I	$\text{k}\Omega$
+ R_{IN}	+ Input Resistance	$V_{CM} = \pm 3.5\text{V}$	1	4		I	$\text{M}\Omega$
+ C_{IN}	+ Input Capacitance			1.2		V	pF
CMIR	Common Mode Input Range		± 3.5	± 4.0		I	V

EL2170C/EL2270C/EL2470C

70 MHz/1 mA Current Mode Feedback Amplifiers

EL2170C/EL2270C/EL2470C

DC Electrical Characteristics — Contd.

$V_S = \pm 5V$, $R_L = 150\Omega$, $T_A = 25^\circ C$ unless otherwise specified

Parameter	Description	Conditions	Min	Typ	Max	Test Level	Units
V_O	Output Voltage Swing	$V_S = \pm 5$	± 3.5	± 4.0		I	V
		$V_S = +5$ Single-Supply, High		4.0		V	V
		$V_S = +5$ Single-Supply, Low		0.3		V	V
I_O	Output Current	EL2170C only	80	100		I	mA
		EL2270C only, per Amplifier	50	55		I	mA
		EL2470C only, per Amplifier	50	55		I	mA
I_S	Supply Current	Per Amplifier		1	2	I	mA

AC Electrical Characteristics

$V_S = \pm 5V$, $R_F = R_G = 1\text{ k}\Omega$, $R_L = 150\Omega$, $T_A = 25^\circ C$ unless otherwise specified

Parameter	Description	Conditions	Min	Typ	Max	Test Level	Units
-3 dB BW	-3 dB Bandwidth	$A_V = +1$		70		V	MHz
-3 dB BW	-3 dB Bandwidth	$A_V = +2$		60		V	MHz
SR	Slew Rate	$V_{OUT} = \pm 2.5V$, $A_V = +2$	400	800		IV	V/ μs
t_r, t_f	Rise and Fall Time	$V_{OUT} = \pm 500\text{ mV}$		4.5		V	ns
t_{pd}	Propagation Delay	$V_{OUT} = \pm 500\text{ mV}$		4.5		V	ns
OS	Overshoot	$V_{OUT} = \pm 500\text{ mV}$		3.0		V	%
t_s	0.1% Settling	$V_{OUT} = \pm 2.5V$, $A_V = -1$		40		V	ns
dG	Differential Gain	$A_V = +2$, $R_L = 150\Omega$ (Note 1)		0.15		V	%
dP	Differential Phase	$A_V = +2$, $R_L = 150\Omega$ (Note 1)		0.15		V	°
dG	Differential Gain	$A_V = +1$, $R_L = 500\Omega$ (Note 1)		0.02		V	%
dP	Differential Phase	$A_V = +1$, $R_L = 500\Omega$ (Note 1)		0.01		V	°
C_S	Channel Separation	EL2270C, EL2470C only, $f = 5\text{ MHz}$		85		V	dB

Note 1: DC offset from 0V to 0.714V, AC amplitude 286 mV_{p,p}, $f = 3.58\text{ MHz}$.

2

EL2170C/EL2270C/EL2470C

70 MHz/1 mA Current Mode Feedback Amplifiers

Test Circuit (per Amplifier)

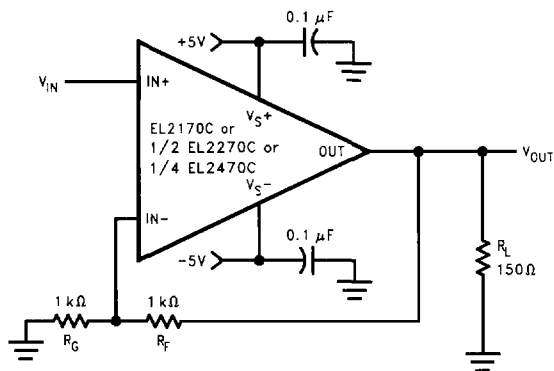

2170-3

Simplified Schematic (per Amplifier)

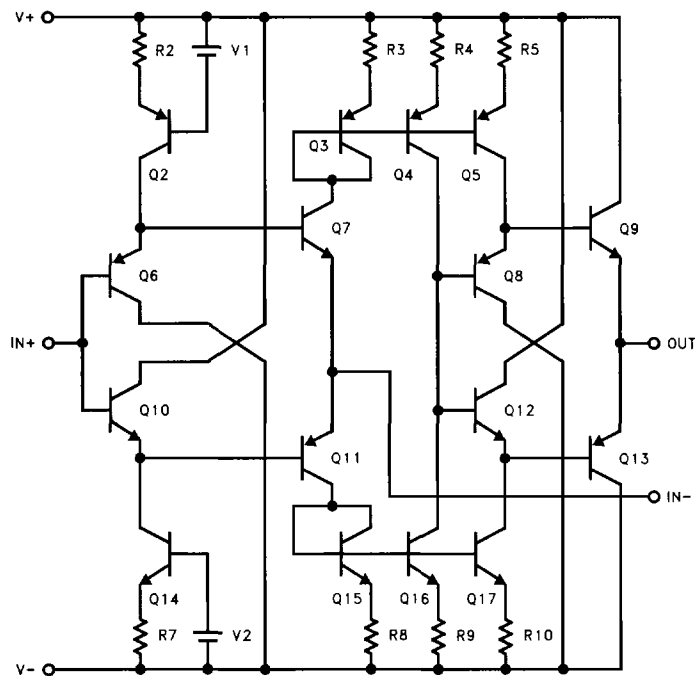

2170-4

EL2170C/EL2270C/EL2470C

70 MHz/1 mA Current Mode Feedback Amplifiers

EL2170C/EL2270C/EL2470C

Typical Performance Curves

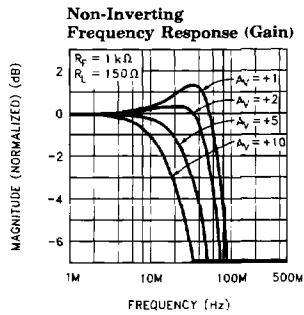

2170-5

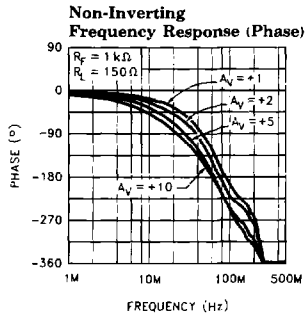

2170-6

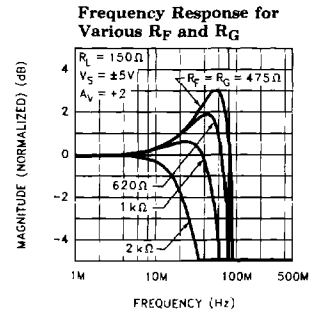

2170-7

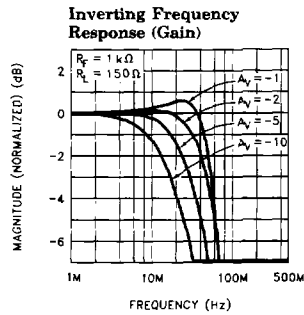

2170-8

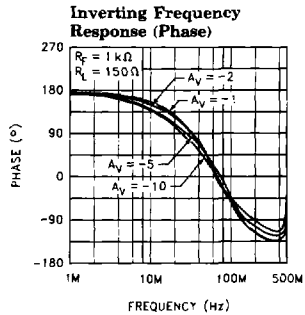

2170-9

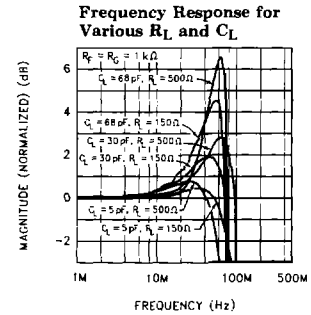

2170-10

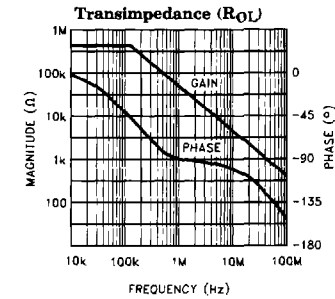

2170-11

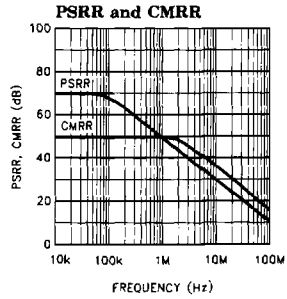

2170-12

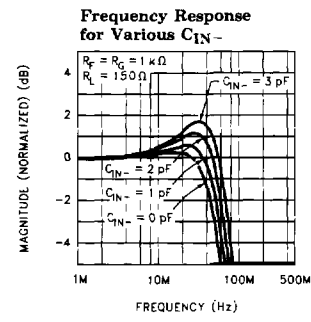

2170-13

2

EL2170C/EL2270C/EL2470C

70 MHz/1 mA Current Mode Feedback Amplifiers

Typical Performance Curves — Contd.

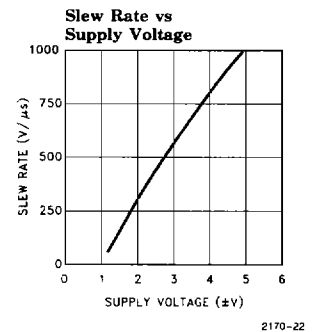
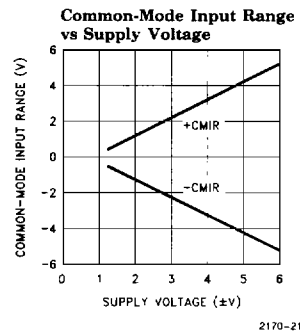
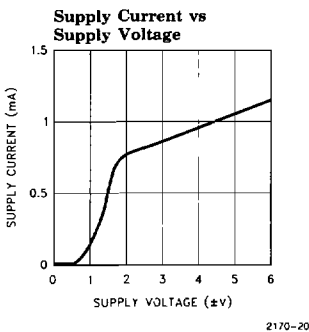
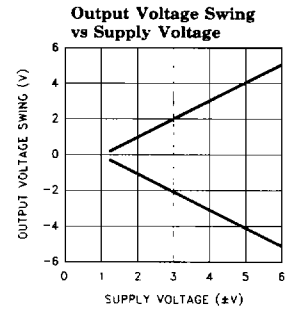
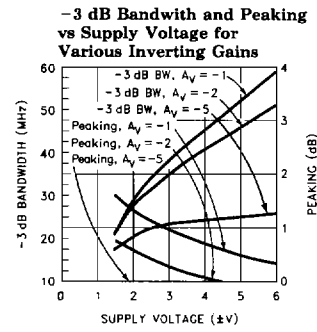
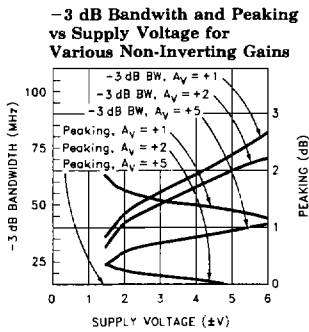
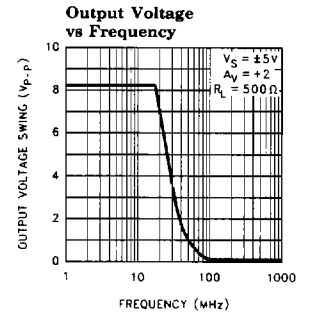
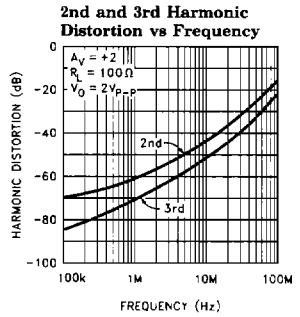
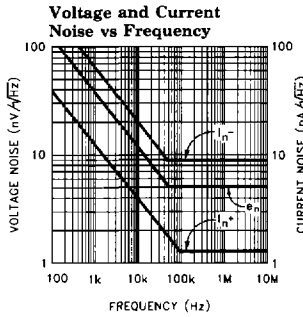

EL2170C/EL2270C/EL2470C

70 MHz/1 mA Current Mode Feedback Amplifiers

EL2170C/EL2270C/EL2470C

Typical Performance Curves — Contd.

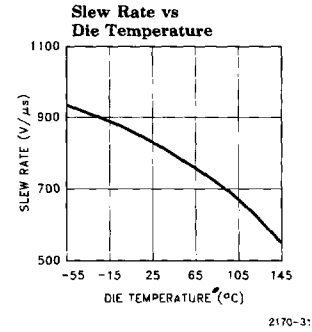
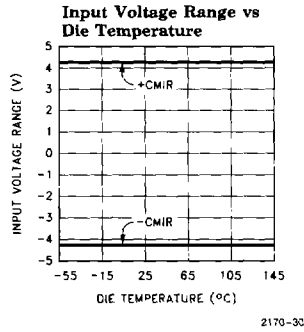
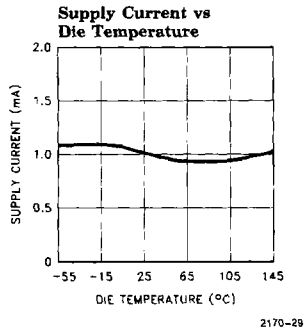
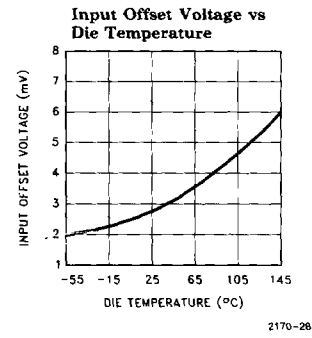
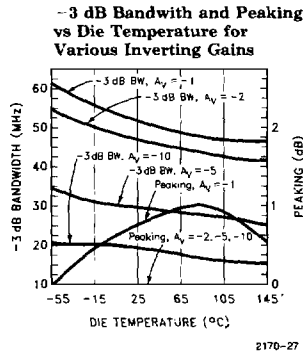
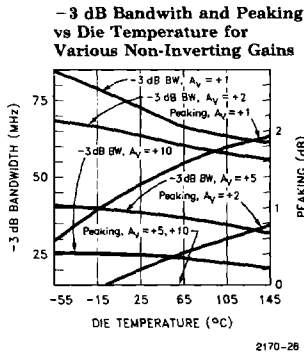
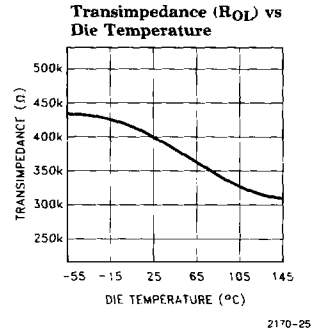
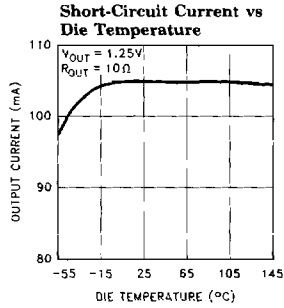
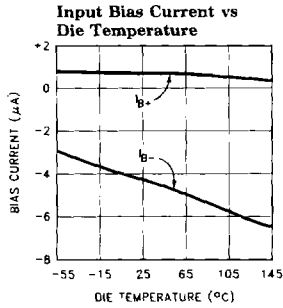

2

EL2170C/EL2270C/EL2470C

70 MHz/1 mA Current Mode Feedback Amplifiers

Typical Performance Curves — Contd.

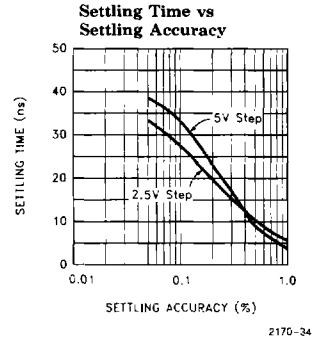
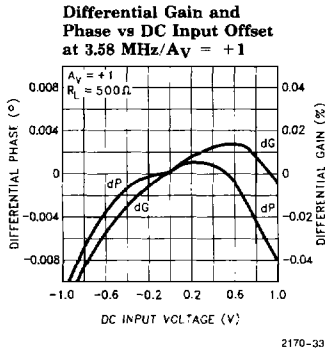
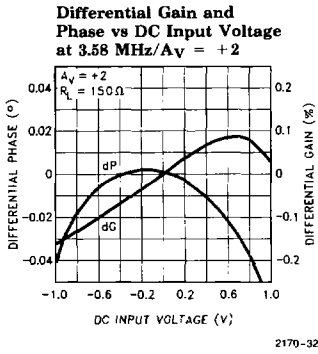

Small-Signal Step Response

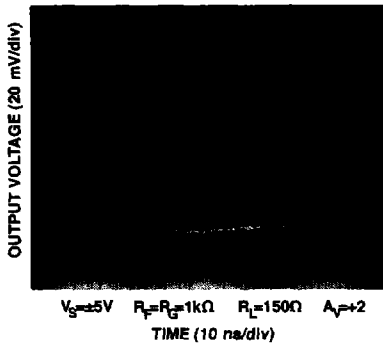

Large-Signal Step Response

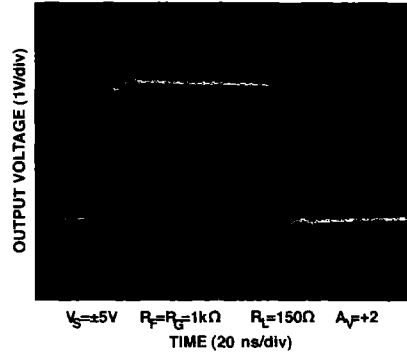

8-Pin Plastic DIP Maximum Power Dissipation vs Ambient Temperature

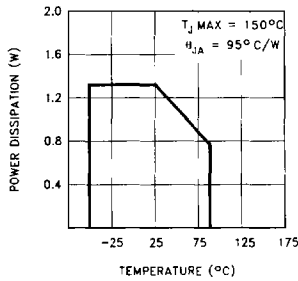

8-Lead SO Maximum Power Dissipation vs Ambient Temperature

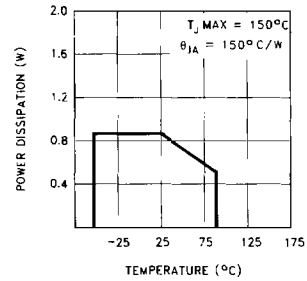

EL2170C/EL2270C/EL2470C

70 MHz/1 mA Current Mode Feedback Amplifiers

EL2170C/EL2270C/EL2470C

Typical Performance Curves — Contd.

14-Pin Plastic DIP
Maximum Power Dissipation
vs Ambient Temperature

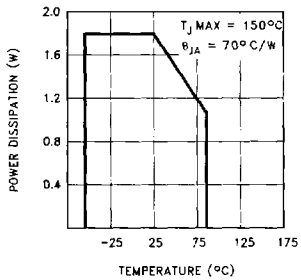

2170-39

14-Lead SO
Maximum Power Dissipation
vs Ambient Temperature

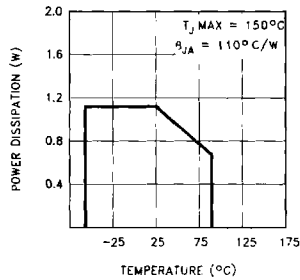

2170-40

Channel Separation
vs Frequency

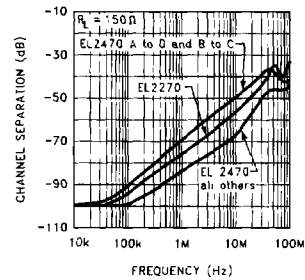

2170-41

5-Lead Plastic SOT23
Maximum Power Dissipation
vs Ambient Temperature

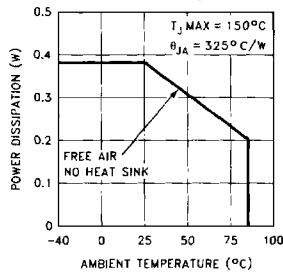

2170-47

EL2170C/EL2270C/EL2470C

70 MHz/1 mA Current Mode Feedback Amplifiers

Applications Information

Product Description

The EL2170C/EL2270C/EL2470C are current-feedback operational amplifiers that offer a wide -3 dB bandwidth of 70 MHz and a low supply current of 1 mA per amplifier. All of these products also feature high output current drive. The EL2170C can output 100 mA, while the EL2270C and the EL2470C can output 55 mA per amplifier. The EL2170C/EL2270C/EL2470C work with supply voltages ranging from a single 3V to ± 6 V, and they are also capable of swinging to within 1V of either supply on the input and the output. Because of their current-feedback topology, the EL2170C/EL2270C/EL2470C do not have the normal gain-bandwidth product associated with voltage-feedback operational amplifiers. This allows their -3 dB bandwidth to remain relatively constant as closed-loop gain is increased. This combination of high bandwidth and low power, together with aggressive pricing make the EL2170C/EL2270C/EL2470C the ideal choice for many low-power/high-bandwidth applications such as portable computing, HDSL, and video processing.

For applications where board space is extremely critical, the EL2170C is available in the tiny 5-Lead SOT23 package, which has a footprint 28% the size of an 8-Lead SOIC. The EL2170C/EL2270C/EL2470C are each also available in industry standard pinouts in PDIP and SOIC packages.

For Single and Dual applications with disable, consider the EL2176C (8-Pin Single) and EL2276C (14-Pin Dual). If higher speed is required, refer to the EL2180C/EL2186C family which provides Singles, Duals, Triples, and Quads with 250 MHz of bandwidth while consuming 3 mA of supply current per amplifier.

Power Supply Bypassing and Printed Circuit Board Layout

As with any high-frequency device, good printed circuit board layout is necessary for optimum performance. Ground plane construction is highly recommended. Lead lengths should be as short as possible. The power supply pins must be well bypassed to reduce the risk of oscillation. The combination of a $4.7 \mu\text{F}$ tantalum capacitor in parallel with a $0.1 \mu\text{F}$ capacitor has been shown to work well when placed at each supply pin.

For good AC performance, parasitic capacitance should be kept to a minimum especially at the inverting input (see the Capacitance at the Inverting Input section). Ground plane construction should be used, but it should be removed from the area near the inverting input to minimize any stray capacitance at that node. Carbon or Metal-Film resistors are acceptable with the Metal-Film resistors giving slightly less peaking and bandwidth because of their additional series inductance. Use of sockets, particularly for the SO package should be avoided if possible. Sockets add parasitic inductance and capacitance which will result in some additional peaking and overshoot.

Capacitance at the Inverting Input

Any manufacturer's high-speed voltage- or current-feedback amplifier can be affected by stray capacitance at the inverting input. For inverting gains this parasitic capacitance has little effect because the inverting input is a virtual ground, but for non-inverting gains this capacitance (in conjunction with the feedback and gain resistors) creates a pole in the feedback path of the amplifier. This pole, if low enough in frequency, has the same destabilizing effect as a zero in the forward open-loop response. The use of large value feedback and gain resistors further exacerbates the problem by further lowering the pole frequency.

EL2170C/EL2270C/EL2470C

70 MHz/1 mA Current Mode Feedback Amplifiers

EL2170C/EL2270C/EL2470C

2

Applications Information — Contd.

The experienced user with a large amount of PC board layout experience may find in rare cases that the EL2170C/EL2270C/EL2470C have less bandwidth than expected. The reduction of feedback resistor values (or the addition of a very small amount of external capacitance at the inverting input, e. g. 0.5 pF) will increase bandwidth as desired. Please see the curves for Frequency Response for Various R_F and R_G , and Frequency Response for Various C_{IN} —.

Feedback Resistor Values

The EL2170C/EL2270C/EL2470C have been designed and specified at gains of +1 and +2 with $R_F = 1 \text{ k}\Omega$. This value of feedback resistor gives 70 MHz of -3 dB bandwidth at $A_V = +1$ with about 1.5 dB of peaking, and 60 MHz of -3 dB bandwidth at $A_V = +2$ with about 0.5 dB of peaking. Since the EL2170C/EL2270C/EL2470C are current-feedback amplifiers, it is also possible to change the value of R_F to get more bandwidth. As seen in the curve of Frequency Response For Various R_F and R_G , bandwidth and peaking can be easily modified by varying the value of the feedback resistor.

Because the EL2170C/EL2270C/EL2470C are current-feedback amplifiers, their gain-bandwidth product is not a constant for different closed-loop gains. This feature actually allows the EL2170C/EL2270C/EL2470C to maintain about the same -3 dB bandwidth, regardless of closed-loop gain. However, as closed-loop gain is increased, bandwidth decreases slightly while stability increases. Since the loop stability is improving with higher closed-loop gains, it becomes possible to reduce the value of R_F below the specified 1 k Ω and still retain stability, resulting in only a slight loss of bandwidth with increased closed-loop gain.

Supply Voltage Range and Single-Supply Operation

The EL2170C/EL2270C/EL2470C have been designed to operate with supply voltages having a span of greater than 3V, and less than 12V. In practical terms, this means that the EL2170C/EL2270C/EL2470C will operate on dual supplies ranging from $\pm 1.5\text{V}$ to $\pm 6\text{V}$. With a single-supply, the EL2170C/EL2270C/EL2470C will operate from +3V to +12V.

As supply voltages continue to decrease, it becomes necessary to provide input and output voltage ranges that can get as close as possible to the supply voltages. The EL2170C/EL2270C/EL2470C have an input voltage range that extends to within 1V of either supply. So, for example, on a single +5V supply, the EL2170C/EL2270C/EL2470C have an input range which spans from 1V to 4V. The output range of the EL2170C/EL2270C/EL2470C is also quite large, extending to within 1V of the supply rail. On a $\pm 5\text{V}$ supply, the output is therefore capable of swinging from -4V to +4V. Single-supply output range is even larger because of the increased negative swing due to the external pull-down resistor to ground. On a single +5V supply, output voltage range is about 0.3V to 4V.

Video Performance

For good video performance, an amplifier is required to maintain the same output impedance and the same frequency response as DC levels are changed at the output. This is especially difficult when driving a standard video load of 150 Ω , because of the change in output current with DC level. Until the EL2170C/EL2270C/EL2470C, good Differential Gain could only be achieved by running high idle currents through the output transistors (to reduce variations in output impedance). These currents were typically more than the entire 1 mA supply current of each EL2170C/EL2270C/EL2470C amplifier! Special circuitry has been incorporated in the EL2170C/EL2270C/EL2470C to reduce the variation of output impedance with current output. This results in dG and dP specifications of 0.15% and 0.15° while driving 150 Ω at a gain of +2.

EL2170C/EL2270C/EL2470C

70 MHz/1 mA Current Mode Feedback Amplifiers

Applications Information — Contd.

Video Performance has also been measured with a 500Ω load at a gain of +1. Under these conditions, the EL2170C/EL2270C/EL2470C have dG and dP specifications of 0.01% and 0.02° respectively while driving 500 Ω at $A_V = +1$.

Output Drive Capability

In spite of its low 1 mA of supply current, the EL2170C is capable of providing a minimum of ±80 mA of output current. Similarly, each amplifier of the EL2270C and the EL2470C is capable of providing a minimum of ±50 mA. These output drive levels are unprecedented in amplifiers running at these supply currents. With a minimum ±80 mA of output drive, the EL2170C is capable of driving 50Ω loads to ±4V, making it an excellent choice for driving isolation transformers in telecommunications applications. Similarly, the ±50 mA minimum output drive of each EL2270C and EL2470C amplifier allows swings of ±2.5V into 50Ω loads.

Driving Cables and Capacitive Loads

When used as a cable driver, double termination is always recommended for reflection-free performance. For those applications, the back-termination series resistor will decouple the EL2170C/EL2270C/EL2470C from the cable and allow extensive capacitive drive. However, other applications may have high capacitive loads without a back-termination resistor. In these applications, a small series resistor (usually between 5Ω and 50Ω) can be placed in series with the output to eliminate most peaking. The gain resistor (R_G) can then be chosen to make up for any gain loss which may be created by this additional resistor at the output. In many cases it is also possible to simply increase the value of the feedback resistor (R_F) to reduce the peaking.

Current Limiting

The EL2170C/EL2270C/EL2470C have no internal current-limiting circuitry. If any output is shorted, it is possible to exceed the Absolute Maximum Ratings for output current or power dissipation, potentially resulting in the destruction of the device.

Power Dissipation

With the high output drive capability of the EL2170C/EL2270C/EL2470C, it is possible to exceed the 150°C Absolute Maximum junction temperature under certain very high load current conditions. Generally speaking, when R_L falls below about 25Ω, it is important to calculate the maximum junction temperature (T_{JMAX}) for the application to determine if power-supply voltages, load conditions, or package type need to be modified for the EL2170C/EL2270C/EL2470C to remain in the safe operating area. These parameters are calculated as follows:

$$T_{JMAX} = T_{MAX} + (\theta_{JA} * n * PD_{MAX}) \quad [1]$$

where:

- T_{MAX} = Maximum Ambient Temperature
- θ_{JA} = Thermal Resistance of the Package
- n = Number of Amplifiers in the Package
- PD_{MAX} = Maximum Power Dissipation of Each Amplifier in the Package.

PD_{MAX} for each amplifier can be calculated as follows:

$$PD_{MAX} = (2 * V_S * I_{SMAX}) + (V_S - V_{OUTMAX}) * (V_{OUTMAX}/R_L) \quad [2]$$

where:

- V_S = Supply Voltage
- I_{SMAX} = Maximum Supply Current of 1 Amplifier
- V_{OUTMAX} = Max. Output Voltage of the Application
- R_L = Load Resistance

EL2170C/EL2270C/EL2470C

70 MHz/1 mA Current Mode Feedback Amplifiers

EL2170C/EL2270C/EL2470C

2

Typical Application Circuits

Inverting 200 mA Output Current Distribution Amplifier

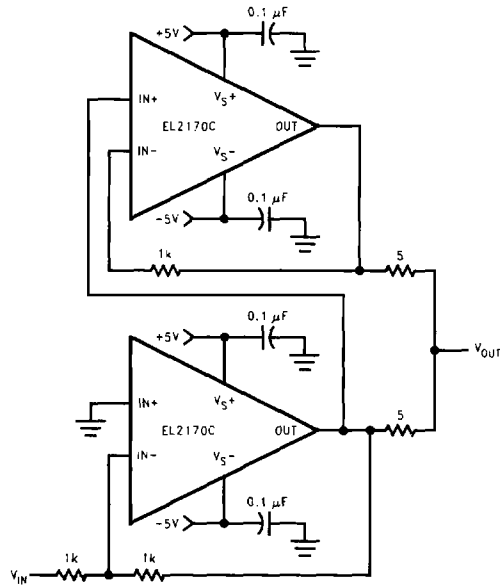

2170-42

Fast-Settling Precision Amplifier

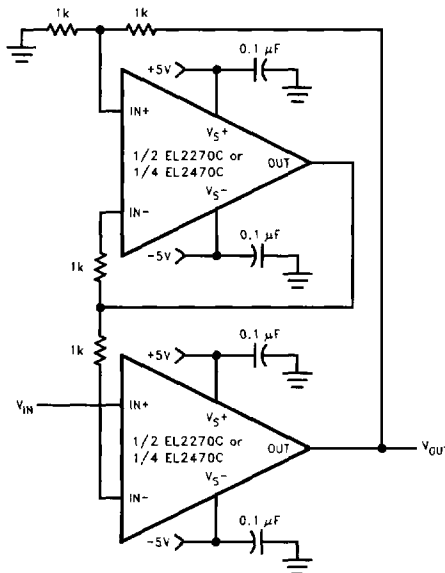

2170-43

EL2170C/EL2270C/EL2470C

70 MHz/1 mA Current Mode Feedback Amplifiers

Typical Application Circuits — Contd.

Differential Line-Driver/Receiver

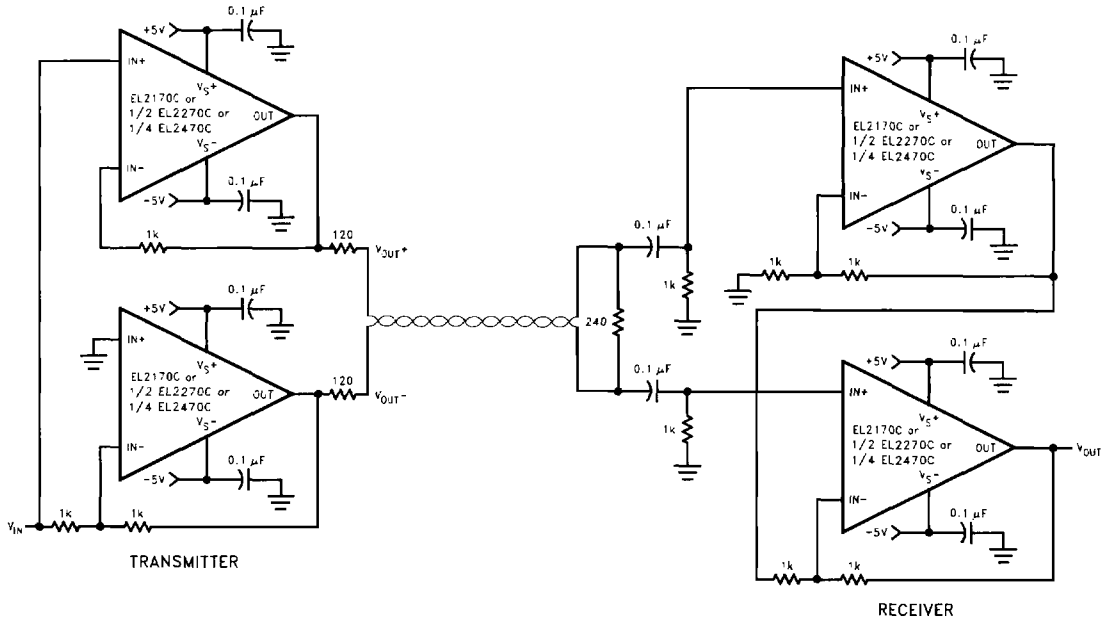

2170-44

EL2170C/EL2270C/EL2470C

70 MHz/1 mA Current Mode Feedback Amplifiers

EL2170C/EL2270C/EL2470C

EL2170C/EL2270C/EL2470C Macromodel

* Revision A, March 1995

* AC characteristics used $R_f = R_g = 1K\Omega$, $R_L = 150\Omega$

* Connections:

+ input		- input		+ Vsupply		- Vsupply		output

.subckt EL2170/el

3 2 7 4 6

* Input Stage

e1 10 0 3 0 1.0

vis 10 9 0V

h2 9 12 vxx 1.0

r1 2 11 165

l1 11 12 25nH

iinp 3 0 0.5uA

iinm 2 0 4uA

r12 3 0 4Meg

* Slew Rate Limiting

h1 13 0 vis 600

r2 13 14 1K

d1 14 0 dclamp

d2 0 14 dclamp

* High Frequency Pole

e2 30 0 14 0 0.001666666666

l3 30 17 0.5uH

c5 17 0 0.69pF

r5 17 0 300

* Transimpedance Stage

g1 0 18 17 0 1.0

rol 18 0 400K

cdp 18 0 1.9pF

* Output Stage

q1 4 18 19 qp

q2 7 18 20 qn

q3 7 19 21 qn

q4 4 20 22 qp

r7 21 6 4

r8 22 6 4

ios1 7 19 0.4mA

ios2 20 4 0.4mA

* Supply Current

ips 7 4 1nA

* Error Terms

ivos 0 23 2mA

vxx 23 0 0V

e4 24 0 3 0 1.0

e5 25 0 7 0 1.0

e6 26 0 4 0 -1.0

r9 24 23 0.316K

r10 25 23 3.2K

r11 26 23 3.2K

* Models

.model qn npn(is = 5e-15 bf = 200 tf = 0.01nS)

.model qp pnp(is = 5e-15 bf = 200 tf = 0.01nS)

.model dclamp d(is = 1e-30 ibv = 0.266

+ bv = 1.3v n = 4)

.ends

