

GlobTek, Inc. www.globtek.com 186 Veterans Drive, Northvale, NJ 07647 Tel. (201) 784-1000 Fax (201) 784-0111	Drawing Title: GTM46161-165.0-USB, ICT / ITE / Medical Power Supply, Efficiency Level: USA DOE Level VI / Eco-design Directive 2009/125/EC, (EU) 2019/1782, Case Color/Style: GlobTek White, Wall Plug-in, Regulated Switchmode AC-DC Power Supply AC Adaptor, Input Rating: 100-240V~, 50-60 Hz, Interchangeable Blades <a href="http://en.globtek.com/interchangeable-blades.php">http://en.globtek.com/interchangeable-blades.php</a> , Output Rating: 16W, 5.0V@3.2A, Output Configuration: N/A mm, N/A/4 Cond, N/A, Type "A" USB "JACK", integral to power supply enclosure, Ferrite: None, N/A, GT Cord # C0132, Pin Out: Pin 1:(+), Pin 2 (D-): Connected to Pin 3 (D+), Pin 3 (D+): Connected to Pin 2 (D-), Pin 4:(-); P2 (D-) and P3 (D+) are shorted together inside power supply., Blades/Input Cord: (Order Separately), Approvals: CCC; RCM; UL 1310; ETL; CB 60601-1; S-Mark IEC/EN 60601-1; S-Mark 60950; EAC; CB 62368; Conforms to 62368-1; LPS 62368; Morocco; LVD 60335; UKCA; India BIS 5V pending; Double Insulation; Ukraine; RoHS; China RoHS; Level VI; WEEE; ETL; CE; FCC; CAN ICES-3; PSE; IP20; CB 60950;	
	Model No. GTM46161-165.0-USB	
	Part No./Ordering No. WR9QA3200USBNMEDR6W	Rev B

In Addition to GlobTek Inc.'s renewed ISO9001:2015 - Quality Management System Certification, GlobTek Inc. is now certified to:

ISO13485:2016 - Medical Devices Quality Management System Certification

ISO14001:2015 - Environmental Management System Certification

ISO Certificates are available online at <https://www.globtek.com/iso-certificates/>

The acceptance of this specification and use of the product described in this document indicates the acceptance and binding of the customer to Globtek TERMS AND CONDITIONS (attached to the end of this document), which supersede all other agreements, terms, and conditions (<https://en.globtek.com/terms-and-conditions/>).

The purchaser of this product (Customer) agrees that it is their sole responsibility to determine suitability/fitness of the product described in this specification for their application and to take precautions for protection against any hazards attendant to the handling and use of the product.

Footnote:

GlobTek Inc. will not be liable for the safety and performance of these power supplies/battery packs if unauthorized access and repair occurs. End user should consult applicable UL, CSA or EN standards for proper installation instruction.

Limitation of Use:

GlobTek products are intended for use with commercial, medical, and/or industrial equipment only. GlobTek product are not authorized for use as mission critical components in life support hazardous environment, nuclear or aircraft applications without prior written approval from the CEO of GlobTek Inc.

Contents of this document are subject to change without prior notice.

### Customer Approval of Specification:

Please approve, sign and send back to GlobTek so we can complete order processing.

A delay in receipt of this form will delay delivery schedule.

Company Name: _____	Customer P/N: _____
Quote Number: _____	Date: _____
Authorized Representative Name: _____	Authorized Representative Signature: _____

GlobTek, Inc. www.globtek.com 186 Veterans Drive, Northvale, NJ 07647 Tel. (201) 784-1000 Fax (201) 784-0111	Drawing Title: GTM46161-165.0-USB, ICT / ITE / Medical Power Supply, Efficiency Level: USA DOE Level VI / Eco-design Directive 2009/125/EC, (EU) 2019/1782, Case Color/Style: GlobTek White, Wall Plug-in, Regulated Switchmode AC-DC Power Supply AC Adaptor, Input Rating: 100-240V~, 50-60 Hz, Interchangeable Blades <a href="http://en.globtek.com/interchangeable-blades.php">http://en.globtek.com/interchangeable-blades.php</a> , Output Rating: 16W, 5.0V@3.2A, Output Configuration: N/A mm, N/A/4 Cond, N/A, Type "A" USB "JACK", integral to power supply enclosure, Ferrite: None, N/A, GT Cord # C0132, Pin Out: Pin 1:(+), Pin 2 (D-): Connected to Pin 3 (D+), Pin 3 (D+): Connected to Pin 2 (D-), Pin 4:(-); P2 (D-) and P3 (D+) are shorted together inside power supply., Blades/Input Cord: (Order Separately), Approvals: CCC; RCM; UL 1310; ETL; CB 60601-1; S-Mark IEC/EN 60601-1; S-Mark 60950; EAC; CB 62368; Conforms to 62368-1; LPS 62368; Morocco; LVD 60335; UKCA; India BIS 5V pending; Double Insulation; Ukraine; RoHS; China RoHS; Level VI; WEEE; ETL; CE; FCC; CAN ICES-3; PSE; IP20; CB 60950;	
	Model No. GTM46161-165.0-USB	
	Part No./Ordering No. WR9QA3200USBNMEDR6W	Rev B

## REVISION HISTORY

REV	DESCRIPTION	SUB	DATE	APPROVED
B	Add label to deviation	QA	04/12/2017	QA
A	Initial release	rchiu	04/06/2017	QA

### POWER SUPPLY INFORMATION

TYPE	Wall Plug-in
TECHNOLOGY	Regulated Switchmode AC-DC Power Supply AC Adaptor
CASE COLOR	GlobTek White
NAMEPLATE RATED INPUT	100-240V~, 50-60 Hz, 0.45A
INPUT CONFIG	Interchangeable Blades
WATTS	16.00
VOLTS OUT	5.0
CURRENT OUT (Amps)	3.2
BLADE/CORD INCLUDED	None (Order Separately)
BLADE/CORD INSTALLED	None :(Order Separately)
INGRESS PROTECTION	Indoor Use
GROUNDING CONFIGURATION	(F1) Class II / Double Insulated
EFFICIENCY LEVEL	<a href="#">USA DOE Level VI</a> / <a href="#">Eco-design Directive 2009/125/EC, (EU) 2019/1782</a> - <a href="#">Europe Code of Conduct on Energy Efficiency of External Power Supplies - Version 5</a>
OUTPUT CONFIGURATION	N/A mm, N/A/4 Cond, N/A, Type "A" USB "JACK", integral to power supply enclosure, Ferrite: None, N/A, GT Cord # C0132
CONNECTOR PIN OUT	Pin 1:(+), Pin 2 (D-): Connected to Pin 3 (D+), Pin 3 (D+): Connected to Pin 2 (D-), Pin 4:(-); P2 (D-) and P3 (D+) are shorted together inside power supply.
LABEL SPECS	ISO 15223 medical device compliant label,L-1470
SPECIAL BARCODE LABEL MATERIAL	No
PACK SPEC	Standard with USB Jack, Individually Box, User manual
USER MANUAL	809-PSUQKITUSERMANUAL on A4 paper

#### PROPRIETARY INFORMATION

PROPRIETARY OF GLOBTEK, INC. ANY REPRODUCTION, DISCLOSURE OR USE OF THIS DRAWING, IN WHOLE OR IN PART, IS HEREBY PROHIBITED EXCEPT AS SPECIFIED IN WRITING BY GLOBTEK, INC. © GlobTek, Inc. 2017 - 2023

GlobTek, Inc. www.globtek.com 186 Veterans Drive, Northvale, NJ 07647 Tel. (201) 784-1000 Fax (201) 784-0111	Drawing Title: GTM46161-165.0-USB, ICT / ITE / Medical Power Supply, Efficiency Level: USA DOE Level VI / Eco-design Directive 2009/125/EC, (EU) 2019/1782, Case Color/Style: GlobTek White, Wall Plug-in, Regulated Switchmode AC-DC Power Supply AC Adaptor, Input Rating: 100-240V~, 50-60 Hz, Interchangeable Blades <a href="http://en.globtek.com/interchangeable-blades.php">http://en.globtek.com/interchangeable-blades.php</a> , Output Rating: 16W, 5.0V@3.2A, Output Configuration: N/A mm, N/A/4 Cond, N/A, Type "A" USB "JACK", integral to power supply enclosure, Ferrite: None, N/A, GT Cord # C0132, Pin Out: Pin 1:(+), Pin 2 (D-): Connected to Pin 3 (D+), Pin 3 (D+): Connected to Pin 2 (D-), Pin 4:(-); P2 (D-) and P3 (D+) are shorted together inside power supply., Blades/Input Cord: (Order Separately), Approvals: CCC; RCM; UL 1310; ETL; CB 60601-1; S-Mark IEC/EN 60601-1; S-Mark 60950; EAC; CB 62368; Conforms to 62368-1; LPS 62368; Morocco; LVD 60335; UKCA; India BIS 5V pending; Double Insulation; Ukraine; RoHS; China RoHS; Level VI; WEEE; ETL; CE; FCC; CAN ICES-3; PSE; IP20; CB 60950;	
	Model No. GTM46161-165.0-USB	
	Part No./Ordering No. WR9QA3200USBNMEDR6W	Rev B

Notes/Modifications/Customizations (notes in this section supersede the values shown in the standard spec)

DIMENSIONS ARE IN MM UNLESS SPECIFIED OTHERWISE

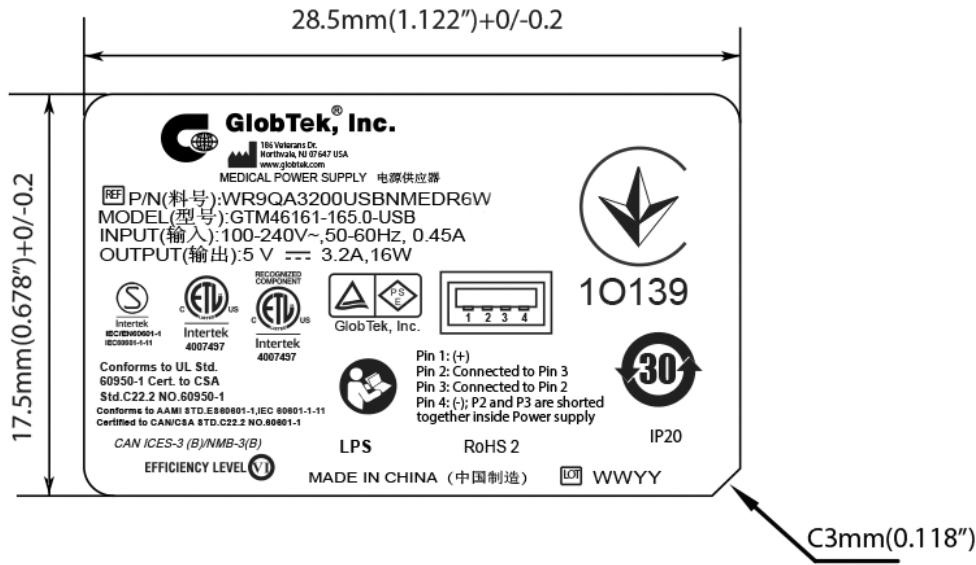

GlobTek, Inc. www.globtek.com 186 Veterans Drive, Northvale, NJ 07647 Tel. (201) 784-1000 Fax (201) 784-0111	Drawing Title: GTM46161-165.0-USB, ICT / ITE / Medical Power Supply, Efficiency Level: USA DOE Level VI / Eco-design Directive 2009/125/EC, (EU) 2019/1782, Case Color/Style: GlobTek White, Wall Plug-in, Regulated Switchmode AC-DC Power Supply AC Adaptor, Input Rating: 100-240V~, 50-60 Hz, Interchangeable Blades <a href="http://en.globtek.com/interchangeable-blades.php">http://en.globtek.com/interchangeable-blades.php</a> , Output Rating: 16W, 5.0V@3.2A, Output Configuration: N/A mm, N/A/4 Cond, N/A, Type "A" USB "JACK", integral to power supply enclosure, Ferrite: None, N/A, GT Cord # C0132, Pin Out: Pin 1:(+), Pin 2 (D-): Connected to Pin 3 (D+), Pin 3 (D+): Connected to Pin 2 (D-), Pin 4:(-); P2 (D-) and P3 (D+) are shorted together inside power supply., Blades/Input Cord: (Order Separately), Approvals: CCC; RCM; UL 1310; ETL; CB 60601-1; S-Mark IEC/EN 60601-1; S-Mark 60950; EAC; CB 62368; Conforms to 62368-1; LPS 62368; Morocco; LVD 60335; UKCA; India BIS 5V pending; Double Insulation; Ukraine; RoHS; China RoHS; Level VI; WEEE; ETL; CE; FCC; CAN ICES-3; PSE; IP20; CB 60950;	
	Model No. GTM46161-165.0-USB	
	Part No./Ordering No. WR9QA3200USBNMEDR6W	Rev B

## ELECTRICAL SPECIFICATIONS

### A) ELECTRICAL SPECIFICATIONS:

1. Input Voltage: Specified 90-264 Vac, Nameplate rated 100-240 Vac
2. Input Frequency: Specified 47-63 Hz, Nameplate rated 50-60 Hz
3. Output Regulation: +/- 5% measured at the end of a 1.2 meter USB cordset employing #20 Gauge conductors (RFP RFI-50856)  
The longest cable GlobTek recommends to be used with this product is USB cord GlobTek PNs USB A1M2MICROB20(R) and USBC1M0USBA(R), 1.2 Meters for best voltage regulation performance. (RFP RFI-20435-3)
4. Line Voltage Regulation: +/- 3% typical
5. Output Ripple (Vp-p): 150mV Ripples shall be measured with a 47uF electrolytic capacitor paralleled with a high-frequency 0.1uF ceramic capacitor across the output. The oscilloscope's bandwidth shall be set to 20MHz.
6. Turn-On/Turn-Off Overshoot: 5% maximum, 500 us maximum recovery time for 25% step load.
7. Turn-On Delay: 3000mS MAX at 115VAC Full Load
8. Hold-Up Time: 8mS Min at 100VAC Full Load
9. Inrush Current: No damage. On power when switching on/off repeatedly under any condition.
10. Switching Frequency: 66.5 KHz typical
11. Average Efficiency: 78.7% Min. (CEC&DOE Level VI Compliant), 79.0% Min. (ErP European Commission's Ecodesign Directive (2005/32/EC) / CoC Tier 2 Compliant)
12. Input Power(no load): < 0.1W < 0.1W, < 0.075W (ErP European Commission's Ecodesign Directive (2005/32/EC) / CoC Tier 2 Compliant)

### B) PROTECTION

1. Over-Voltage: Output shut down and auto restart
2. Over Temperature Protection: Output shut down and auto restart
3. Short Circuit Protection Output shut down and auto restart
4. Over Load Protection Output shut down and auto restart
5. Input Protection: Input line fusing
6. ESD: 8 kV Contact/20kV Air Discharge

### C) SAFETY

1. Dielectric Withstand Voltage: 4000Vac or 5656Vdc 10mA 1 minute
2. Earth Leakage Current: N/A for Class II units, there is no PE Ground pin, so Earth Leakage current is not measured
3. Touch Current: Maximum allowed values: 100uA NC(Normal condition) 500uA SFC(single fault condition)
4. Means of Protection: 2 x MOPP
5. ROHS 2: Complies with EU 2011/65/EU and China SJ/T 11363-2006

### D) EMC

1. Emissions, per EN 55032, EN 61000-6-3, EN 61000-6-4  
Conducted Emissions: Class B, FCC Part 15, Class B  
Radiated Emissions: Class B, FCC Part 15, Class B
2. Line Frequency Harmonics EN61000-3-2, Class A
3. Voltage Fluctuations/Flicker EN61000-3-3
4. Immunity, per EN 55024, EN 61000-6-1, EN 61000-6-2  
Static Discharge Immunity EN61000-4-2, 8kV Contact Discharge, 15kV air discharge  
Radiated RF Immunity EN61000-4-3, 3V/m 80-2700MHz, 80% 1KHz AM.  
EFT/Burst Immunity EN61000-4-4, 2kV/100kHz.  
Line Surge Immunity EN61000-4-5, 1kV differential, 2kV common-mode  
Conducted RF Immunity EN61000-4-6, 3Vrms, 80% 1KHz AM

#### PROPRIETARY INFORMATION

PROPRIETARY OF GLOBTEK, INC. ANY REPRODUCTION, DISCLOSURE OR USE OF THIS DRAWING, IN WHOLE OR IN PART, IS HEREBY PROHIBITED EXCEPT AS SPECIFIED IN WRITING BY GLOBTEK, INC. © GlobTek, Inc. 2017 - 2023

<p>GlobTek, Inc. www.globtek.com 186 Veterans Drive, Northvale, NJ 07647 Tel. (201) 784-1000 Fax (201) 784-0111</p>	<p>Drawing Title: GTM46161-165.0-USB, ICT / ITE / Medical Power Supply, Efficiency Level: USA DOE Level VI / Eco-design Directive 2009/125/EC, (EU) 2019/1782, Case Color/Style: GlobTek White, Wall Plug-in, Regulated Switchmode AC-DC Power Supply AC Adaptor, Input Rating: 100-240V~, 50-60 Hz, Interchangeable Blades <a href="http://en.globtek.com/interchangeable-blades.php">http://en.globtek.com/interchangeable-blades.php</a>, Output Rating: 16W, 5.0V@3.2A, Output Configuration: N/A mm, N/A/4 Cond, N/A, Type "A" USB "JACK", integral to power supply enclosure, Ferrite: None, N/A, GT Cord # C0132, Pin Out: Pin 1:(+), Pin 2 (D-): Connected to Pin 3 (D+), Pin 3 (D+): Connected to Pin 2 (D-), Pin 4:(-); P2 (D-) and P3 (D+) are shorted together inside power supply., Blades/Input Cord: (Order Separately), Approvals: CCC; RCM; UL 1310; ETL; CB 60601-1; S-Mark IEC/EN 60601-1; S-Mark 60950; EAC; CB 62368; Conforms to 62368-1; LPS 62368; Morocco; LVD 60335; UKCA; India BIS 5V pending; Double Insulation; Ukraine; RoHS; China RoHS; Level VI; WEEE; ETL; CE; FCC; CAN ICES-3; PSE; IP20; CB 60950;</p>
	<p>Model No. GTM46161-165.0-USB</p>
	<p>Part No./Ordering No. WR9QA3200USBNMEDR6W</p>
	<p>Rev B</p>

<p>Power Frequency Magnetic Field Immunity EN61000-4-8, NA Voltage Dip Immunity EN61000-4-11, Criteria</p> <p>E) OTHER:</p> <ol style="list-style-type: none"> <li>1. USB2.0 , BC1.2 compliant</li> <li>2. MTBF: 200,000 hours @ 25°C ambient temperature</li> <li>3. Operating Temperature: 0°C to 40°C ambient temperature</li> <li>4. Humidity: 0% to 95% relative humidity</li> <li>5. Storage Temperature: -40°C to 80°C</li> </ol> <p>F) ENCLOSURE</p> <ol style="list-style-type: none"> <li>1. Housing: High impact plastic, 94V0 polycarbonate, non-vented</li> <li>2. Markings: Label and/or Pad Printed and/or Molded in the case</li> </ol> <hr/> <p>TO ADDRESS SYSTEM-LEVEL EMI CONCERNS, FERRITE CHOKES/BEADS MAY BE ADDED/REVISED UPON REQUEST. A SAMPLE KIT OF GLOBTEK'S STANDARD FERRITES IS AVAILABLE UNDER GLOBTEK P/N: EMI-MITIGATION-KIT1</p> <p>FOR ADDITIONAL INFORMATION, PLEASE READ OUR WHITE PAPER AT: <a href="https://r.globtek.info/3QeaqtD">https://r.globtek.info/3QeaqtD</a></p> <p>INGRESS PROTECTION: Indoor Use</p>
---

<p>GlobTek, Inc.  www.globtek.com  186 Veterans Drive,  Northvale, NJ 07647  Tel. (201) 784-1000  Fax (201) 784-0111</p>	<p>Drawing Title: GTM46161-165.0-USB, ICT / ITE / Medical Power Supply, Efficiency Level: USA DOE Level VI / Eco-design Directive 2009/125/EC, (EU) 2019/1782, Case Color/Style: GlobTek White, Wall Plug-in, Regulated Switchmode AC-DC Power Supply AC Adaptor, Input Rating: 100-240V~, 50-60 Hz, Interchangeable Blades <a href="http://en.globtek.com/interchangeable-blades.php">http://en.globtek.com/interchangeable-blades.php</a>, Output Rating: 16W, 5.0V@3.2A, Output Configuration: N/A mm, N/A/4 Cond, N/A, Type "A" USB "JACK", integral to power supply enclosure, Ferrite: None, N/A, GT Cord # C0132, Pin Out: Pin 1:(+), Pin 2 (D-): Connected to Pin 3 (D+), Pin 3 (D+): Connected to Pin 2 (D-), Pin 4:(-); P2 (D-) and P3 (D+) are shorted together inside power supply., Blades/Input Cord: (Order Separately), Approvals: CCC; RCM; UL 1310; ETL; CB 60601-1; S-Mark IEC/EN 60601-1; S-Mark 60950; EAC; CB 62368; Conforms to 62368-1; LPS 62368; Morocco; LVD 60335; UKCA; India BIS 5V pending; Double Insulation; Ukraine; RoHS; China RoHS; Level VI; WEEE; ETL; CE; FCC; CAN ICES-3; PSE; IP20; CB 60950;</p>
	<p>Model No. GTM46161-165.0-USB</p>
	<p>Part No./Ordering No. WR9QA3200USBNMEDR6W</p>
	<p>Rev B</p>

3D File Download <https://www.globtek.com/file/dl/051515.rar>

Mechanical drawing



GlobTek, Inc.  
 www.globtek.com  
 186 Veterans Drive,  
 Northvale, NJ 07647  
 Tel. (201) 784-1000  
 Fax (201) 784-0111

Drawing Title: GTM46161-165.0-USB, ICT / ITE / Medical Power Supply, Efficiency Level: USA DOE Level VI / Eco-design Directive 2009/125/EC, (EU) 2019/1782, Case Color/Style: GlobTek White, Wall Plug-in, Regulated Switchmode AC-DC Power Supply AC Adaptor, Input Rating: 100-240V~, 50-60 Hz, Interchangeable Blades <http://en.globtek.com/interchangeable-blades.php>, Output Rating: 16W, 5.0V@3.2A, Output Configuration: N/A mm, N/A/4 Cond, N/A, Type "A" USB "JACK", integral to power supply enclosure, Ferrite: None, N/A, GT Cord # C0132, Pin Out: Pin 1:(+), Pin 2 (D-): Connected to Pin 3 (D+), Pin 3 (D+): Connected to Pin 2 (D-), Pin 4:(-); P2 (D-) and P3 (D+) are shorted together inside power supply., Blades/Input Cord: (Order Separately), Approvals: CCC; RCM; UL 1310; ETL; CB 60601-1; S-Mark IEC/EN 60601-1; S-Mark 60950; EAC; CB 62368; Conforms to 62368-1; LPS 62368; Morocco; LVD 60335; UKCA; India BIS 5V pending; Double Insulation; Ukraine; RoHS; China RoHS; Level VI; WEEE; ETL; CE; FCC; CAN ICES-3; PSE; IP20; CB 60950;

Model No. GTM46161-165.0-USB

Part No./Ordering No. WR9QA3200USBNMEDR6W

Rev B

DERATING CURVE

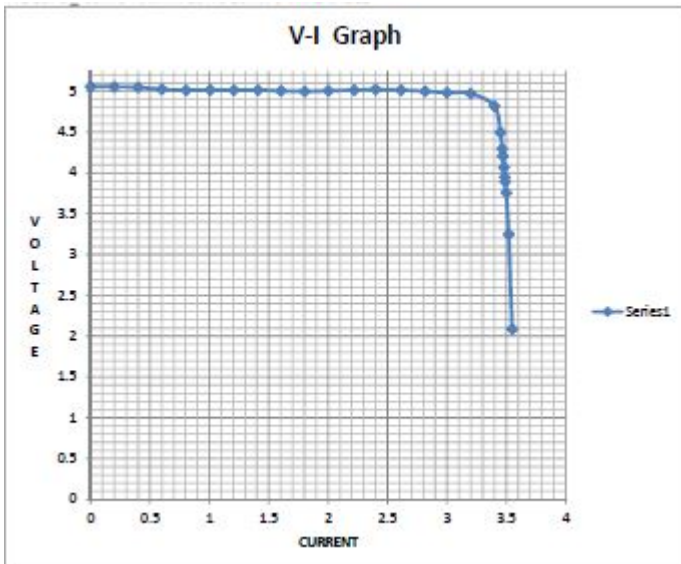
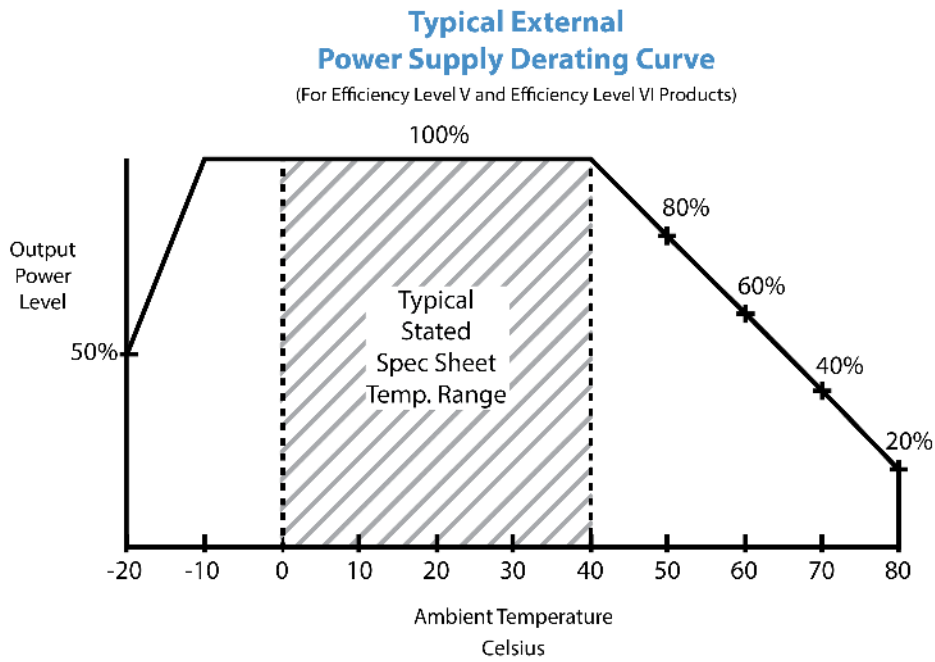

GlobTek, Inc. www.globtek.com 186 Veterans Drive, Northvale, NJ 07647 Tel. (201) 784-1000 Fax (201) 784-0111	Drawing Title: GTM46161-165.0-USB, ICT / ITE / Medical Power Supply, Efficiency Level: USA DOE Level VI / Eco-design Directive 2009/125/EC, (EU) 2019/1782, Case Color/Style: GlobTek White, Wall Plug-in, Regulated Switchmode AC-DC Power Supply AC Adaptor, Input Rating: 100-240V~, 50-60 Hz, Interchangeable Blades <a href="http://en.globtek.com/interchangeable-blades.php">http://en.globtek.com/interchangeable-blades.php</a> , Output Rating: 16W, 5.0V@3.2A, Output Configuration: N/A mm, N/A/4 Cond, N/A, Type "A" USB "JACK", integral to power supply enclosure, Ferrite: None, N/A, GT Cord # C0132, Pin Out: Pin 1:(+), Pin 2 (D-): Connected to Pin 3 (D+), Pin 3 (D+): Connected to Pin 2 (D-), Pin 4:(-); P2 (D-) and P3 (D+) are shorted together inside power supply., Blades/Input Cord: (Order Separately), Approvals: CCC; RCM; UL 1310; ETL; CB 60601-1; S-Mark IEC/EN 60601-1; S-Mark 60950; EAC; CB 62368; Conforms to 62368-1; LPS 62368; Morocco; LVD 60335; UKCA; India BIS 5V pending; Double Insulation; Ukraine; RoHS; China RoHS; Level VI; WEEE; ETL; CE; FCC; CAN ICES-3; PSE; IP20; CB 60950;
	Model No. GTM46161-165.0-USB
	Part No./Ordering No. WR9QA3200USBNMEDR6W <span style="float: right;">Rev B</span>

## INPUT CONFIGURATION

(F1) Class II / Double Insulated

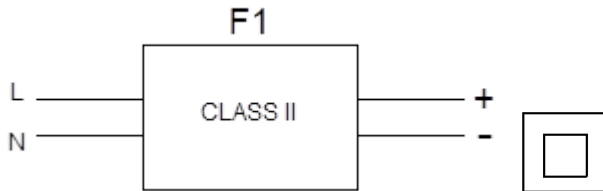

[Alternate grounding configurations](#) available upon request.

Blades/Cord Included:None:(Order Separately)

Blades/Cord Installed:None:(Order Separately)

Blade Options for Q Series Wall Plug-in Power Supplies

Data Sheet: <http://en.globtek.com/interchangeable-blades.php>

Insertion Instructions: <http://www.globtek.com/pdf/Instructions-Interchangeable-Blades.pdf>

Video: [Q-Blade Style Instruction Video](#)



### PROPRIETARY INFORMATION

PROPRIETARY OF GLOBTEK, INC. ANY REPRODUCTION, DISCLOSURE OR USE OF THIS DRAWING, IN WHOLE OR IN PART, IS HEREBY PROHIBITED EXCEPT AS SPECIFIED IN

WRITING BY GLOBTEK, INC. © GlobTek, Inc. 2017 - 2023

quest / 08/08/2023 9:02:03 AM GMT CLONED FROM WR9QA2000USBNMEDR6W



GloTek, Inc. www.globtek.com 186 Veterans Drive, Northvale, NJ 07647 Tel. (201) 784-1000 Fax (201) 784-0111	Drawing Title: GTM46161-165.0-USB, ICT / ITE / Medical Power Supply, Efficiency Level: USA DOE Level VI / Eco-design Directive 2009/125/EC, (EU) 2019/1782, Case Color/Style: GloTek White, Wall Plug-in, Regulated Switchmode AC-DC Power Supply AC Adaptor, Input Rating: 100-240V~, 50-60 Hz, Interchangeable Blades <a href="http://en.globtek.com/interchangeable-blades.php">http://en.globtek.com/interchangeable-blades.php</a> , Output Rating: 16W, 5.0V@3.2A, Output Configuration: N/A mm, N/A/4 Cond, N/A, Type "A" USB "JACK", integral to power supply enclosure, Ferrite: None, N/A, GT Cord # C0132, Pin Out: Pin 1:(+), Pin 2 (D-): Connected to Pin 3 (D+), Pin 3 (D+): Connected to Pin 2 (D-), Pin 4:(-); P2 (D-) and P3 (D+) are shorted together inside power supply., Blades/Input Cord: (Order Separately), Approvals: CCC; RCM; UL 1310; ETL; CB 60601-1; S-Mark IEC/EN 60601-1; S-Mark 60950; EAC; CB 62368; Conforms to 62368-1; LPS 62368; Morocco; LVD 60335; UKCA; India BIS 5V pending; Double Insulation; Ukraine; RoHS; China RoHS; Level VI; WEEE; ETL; CE; FCC; CAN ICES-3; PSE; IP20; CB 60950;	
	Model No. GTM46161-165.0-USB	
	Part No./Ordering No. WR9QA3200USBNMEDR6W	Rev B

INPUT CONNECTOR: Q-Socket (below are available blades configurations which are "not included" (unless stated above); can be purchased separately, package with power supply or as a separate "Q-KIT" if specified

01. United States / Canada / Japan NEMA 1-15P/ IEC PLUG Type A [WORKS IN PLUG B] configuration: NA 2 blades, Class II; US/CA/JP P/N: Q-NA(R)
02. Australian AS 3112 configuration: SAA 2 blade/ IEC TYPE I, Class II; AU P/N: Q-SAA(R)
03. UK BS 1363 configuration: UK 3 blade with dummy Ground/ IEC TYPE G, Class II; GB P/N: Q-UK(R)
04. European CEE 7/16 configuration: Europlug 2 pins/ IEC TYPE C [WORKS IN TYPE E&F], Class II; EU P/N: Q-EU(R)
05. Korean KS C8305 configuration: 2 pins/SIMILAR TO IEC TYPE C, Class II; KR P/N: Q-KR(R)
06. Argentina IRAM 2073 configuration: 2 blades/SIMILAR TO IEC TYPE I; AR P/N: Class II Q-AR(R)
07. China GB 2099 configuration: 2 blades/SIMILAR TO TYPE A, Class II; CN P/N:Q-CN(R)
08. India IS 1293 6A/BS546 configuration: 5A, 3 pins with Dummy Ground, Class II/IEC TYPE D; IN P/N: Q-IN(R)
09. IEC60320/C18 Inlet, Class II; P/N: Q-C18(R)
10. Brazilian NBR6147 configuration: 2 pins, Class II;SIMILAR TO IEC TYPE C BR P/N: Q-BR(R)
11. South Africa SABS164-1 and India IS 1293, IS694, 16A type plug, 3 round prongs, Class II + dummy ground, IEC TYPE M P/N: Q-SANS164-1-16A(R)
12. South Africa SABS164-4, 3 round prongs with a notched prong @ 0°, Class II + dummy ground, IEC TYPE M Red, P/N: Q-SANS164-4C-16A(R)
13. South Africa SABS164-4, 3 round prongs with a notched prong @ -53°, Class II + dummy ground, Blue, IEC TYPE M, P/N: Q-SANS164-4L-16A(R)
14. South Africa SABS164-4, 3 round prongs with a notched prong @ +53°, Class II + dummy ground, Black,IEC TYPE M P/N: Q-SANS164-4R-16A(R)

#### Kits

01. Q-KIT: 1,2,3,4 above
02. Q-KIT-INTL: 2,3,4 above
03. Q-KIT-6: 1,2,3,4,5,6 above
04. Q-KIT-7: 1,2,3,4,5,6,7 above
05. Q-KIT-8: 1,2,3,4,5,6,7,8 above

GlobTek, Inc. www.globtek.com 186 Veterans Drive, Northvale, NJ 07647 Tel. (201) 784-1000 Fax (201) 784-0111	Drawing Title: GTM46161-165.0-USB, ICT / ITE / Medical Power Supply, Efficiency Level: USA DOE Level VI / Eco-design Directive 2009/125/EC, (EU) 2019/1782, Case Color/Style: GlobTek White, Wall Plug-in, Regulated Switchmode AC-DC Power Supply AC Adaptor, Input Rating: 100-240V~, 50-60 Hz, Interchangeable Blades <a href="http://en.globtek.com/interchangeable-blades.php">http://en.globtek.com/interchangeable-blades.php</a> , Output Rating: 16W, 5.0V@3.2A, Output Configuration: N/A mm, N/A/4 Cond, N/A, Type "A" USB "JACK", integral to power supply enclosure, Ferrite: None, N/A, GT Cord # C0132, Pin Out: Pin 1:(+), Pin 2 (D-): Connected to Pin 3 (D+), Pin 3 (D+): Connected to Pin 2 (D-), Pin 4:(-); P2 (D-) and P3 (D+) are shorted together inside power supply., Blades/Input Cord: (Order Separately), Approvals: CCC; RCM; UL 1310; ETL; CB 60601-1; S-Mark IEC/EN 60601-1; S-Mark 60950; EAC; CB 62368; Conforms to 62368-1; LPS 62368; Morocco; LVD 60335; UKCA; India BIS 5V pending; Double Insulation; Ukraine; RoHS; China RoHS; Level VI; WEEE; ETL; CE; FCC; CAN ICES-3; PSE; IP20; CB 60950;	
	Model No. GTM46161-165.0-USB	
	Part No./Ordering No. WR9QA3200USBNMEDR6W	Rev B

**OUTPUT CORD AND CONNECTOR: USBMT/C0132**

ACTUAL CONNECTORS, OVERMOLDS, FERRITES MAY VARY SLIGHTLY FROM THE PICTURE BELOW

CABLE TYPE	N/A
CABLE LENGTH (mm)	N/A
CABLE TOLERANCE (mm)	N/A
WIRE GAUGE (AWG)	N/A
CONDUCTORS	4
HANK DIMENSION (mm)	N/A
CABLE / CONNECTOR OVERMOLD COLOR	N/A
FERRITE TYPE AND DIMENSION	None
FERRITE NUMBER OF TURNS <a href="#">(Definition)</a>	N/A
FERRITE DIMENSION FROM STRAIN RELIEF	N/A
FERRITE DIMENSION FROM PLUG	N/A
PLUG TYPE	Type "A" USB "JACK", integral to power supply enclosure
OVER MOLD ORIENTATION	PCB Mount Connector
CONNECTOR PIN OUT	Pin 1:(+), Pin 2 (D-): Connected to Pin 3 (D+), Pin 3 (D+): Connected to Pin 2 (D-), Pin 4:(-); P2 (D-) and P3 (D+) are shorted together inside power supply.
ADDITIONAL REQUIREMENTS	

Front View

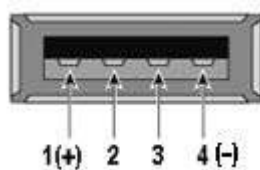

ADDITIONAL OUTPUT PLUG OPTIONS ARE AVAILABLE AT <https://www.globtek.com/connectors/>  
STANDARD PLUGS AND CONNECTORS CAN BE SEEN ONLINE AT <https://www.globtek.com/connectors/>  
CALCULATE VOLTAGE REGULATION/DROP WITH OUR ONLINE CALCULATOR: <https://en.globtek.com/output-cable-regulation-calculator/>

GlobTek, Inc. www.globtek.com 186 Veterans Drive, Northvale, NJ 07647 Tel. (201) 784-1000 Fax (201) 784-0111	Drawing Title: GTM46161-165.0-USB, ICT / ITE / Medical Power Supply, Efficiency Level: USA DOE Level VI / Eco-design Directive 2009/125/EC, (EU) 2019/1782, Case Color/Style: GlobTek White, Wall Plug-in, Regulated Switchmode AC-DC Power Supply AC Adaptor, Input Rating: 100-240V~, 50-60 Hz, Interchangeable Blades <a href="http://en.globtek.com/interchangeable-blades.php">http://en.globtek.com/interchangeable-blades.php</a> , Output Rating: 16W, 5.0V@3.2A, Output Configuration: N/A mm, N/A/4 Cond, N/A, Type "A" USB "JACK", integral to power supply enclosure, Ferrite: None, N/A, GT Cord # C0132, Pin Out: Pin 1:(+), Pin 2 (D-): Connected to Pin 3 (D+), Pin 3 (D+): Connected to Pin 2 (D-), Pin 4:(-); P2 (D-) and P3 (D+) are shorted together inside power supply., Blades/Input Cord: (Order Separately), Approvals: CCC; RCM; UL 1310; ETL; CB 60601-1; S-Mark IEC/EN 60601-1; S-Mark 60950; EAC; CB 62368; Conforms to 62368-1; LPS 62368; Morocco; LVD 60335; UKCA; India BIS 5V pending; Double Insulation; Ukraine; RoHS; China RoHS; Level VI; WEEE; ETL; CE; FCC; CAN ICES-3; PSE; IP20; CB 60950;	
	Model No. GTM46161-165.0-USB	
	Part No./Ordering No. WR9QA3200USBNMEDR6W	Rev B

## OUTPUT CONNECTOR HOOK UP

TO ADDRESS SYSTEM-LEVEL EMI CONCERNS, FERRITE CHOKES/BEADS MAY BE ADDED/REVISED UPON REQUEST. A SAMPLE KIT OF GLOBTEK'S STANDARD FERRITES IS AVAILABLE UNDER GLOBTEK P/N: EMI-MITIGATION-KIT1

FOR ADDITIONAL INFORMATION, PLEASE READ OUR WHITE PAPER AT:

<https://en.globtek.com/technical-articles/ferrite-kit-radiated-emi-suppression-kit-for-globtek-power-supplies-cable-assemblies>

### PROPRIETARY INFORMATION

PROPRIETARY OF GLOBTEK, INC. ANY REPRODUCTION, DISCLOSURE OR USE OF THIS DRAWING, IN WHOLE OR IN PART, IS HEREBY PROHIBITED EXCEPT AS SPECIFIED IN Page 11 of 18

WRITING BY GLOBTEK, INC. © GlobTek, Inc. 2017 - 2023

quest / 08/08/2023 9:02:03 AM GMT CLONED FROM WR9QA2000USBNMEDR6W

GlobTek, Inc. www.globtek.com 186 Veterans Drive, Northvale, NJ 07647 Tel. (201) 784-1000 Fax (201) 784-0111	Drawing Title: GTM46161-165.0-USB, ICT / ITE / Medical Power Supply, Efficiency Level: USA DOE Level VI / Eco-design Directive 2009/125/EC, (EU) 2019/1782, Case Color/Style: GlobTek White, Wall Plug-in, Regulated Switchmode AC-DC Power Supply AC Adaptor, Input Rating: 100-240V~, 50-60 Hz, Interchangeable Blades <a href="http://en.globtek.com/interchangeable-blades.php">http://en.globtek.com/interchangeable-blades.php</a> , Output Rating: 16W, 5.0V@3.2A, Output Configuration: N/A mm, N/A/4 Cond, N/A, Type "A" USB "JACK", integral to power supply enclosure, Ferrite: None, N/A, GT Cord # C0132, Pin Out: Pin 1:(+), Pin 2 (D-): Connected to Pin 3 (D+), Pin 3 (D+): Connected to Pin 2 (D-), Pin 4:(-); P2 (D-) and P3 (D+) are shorted together inside power supply., Blades/Input Cord: (Order Separately), Approvals: CCC; RCM; UL 1310; ETL; CB 60601-1; S-Mark IEC/EN 60601-1; S-Mark 60950; EAC; CB 62368; Conforms to 62368-1; LPS 62368; Morocco; LVD 60335; UKCA; India BIS 5V pending; Double Insulation; Ukraine; RoHS; China RoHS; Level VI; WEEE; ETL; CE; FCC; CAN ICES-3; PSE; IP20; CB 60950;	
	Model No. GTM46161-165.0-USB	
	Part No./Ordering No. WR9QA3200USBNMEDR6W	Rev B

**LABEL:L-1470**

LABEL P/N	ISO 15223 medical device compliant label
MATERIAL	Flat Thermal Transfer, Imprintable, Polyester Label and/or Pad Printed and/or Molded, and/or Laser Engraved in the case
BACKGROUND COLOR	Black if housing is Black, White or Silver if housing is White or Gray.
TEXT COLOR	White or Silver if label is Black Background for Black housing. Black if label is White or Silver background and Housing is White or Gray.
LABEL WIDTH (mm)	28.5
LABEL HEIGHT (mm)	17.5
SPECIAL BARCODE LABEL MATERIAL	No

Below is the minimum information which will appear on the label. NOTE: in the logo area additional/actual positioning of symbols and text is subjected to change as per agency updates/requirements or additional model approvals become available.

Agency logos may be in Regulatory Certifications/Label Markings area on the label or molded into the case housing outside the label area. Information will be shown via Label and/or Pad Printed and/or Molded in the case.

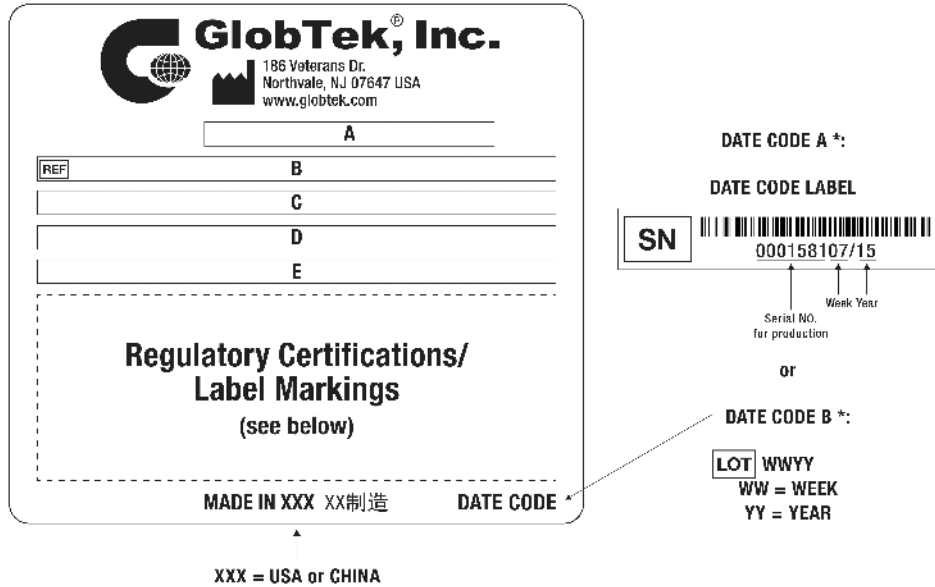

- A=ICT / ITE / Medical Power Supply
- B=P/N: (料号) WR9QA3200USBNMEDR6W
- C=Model (型号) GTM46161-165.0-USB
- D=Input (输入)100-240V~, 50-60 Hz, 0.45A
- E=Output (输出)5.0 V 3.2 A, 16.00W

GloBtek, Inc. www.globtek.com 186 Veterans Drive, Northvale, NJ 07647 Tel. (201) 784-1000 Fax (201) 784-0111	Drawing Title: GTM46161-165.0-USB, ICT / ITE / Medical Power Supply, Efficiency Level: USA DOE Level VI / Eco-design Directive 2009/125/EC, (EU) 2019/1782, Case Color/Style: GloBtek White, Wall Plug-in, Regulated Switchmode AC-DC Power Supply AC Adaptor, Input Rating: 100-240V~, 50-60 Hz, Interchangeable Blades <a href="http://en.globtek.com/interchangeable-blades.php">http://en.globtek.com/interchangeable-blades.php</a> , Output Rating: 16W, 5.0V@3.2A, Output Configuration: N/A mm, N/A/4 Cond, N/A, Type "A" USB "JACK", integral to power supply enclosure, Ferrite: None, N/A, GT Cord # C0132, Pin Out: Pin 1:(+), Pin 2 (D-): Connected to Pin 3 (D+), Pin 3 (D+): Connected to Pin 2 (D-), Pin 4:(-); P2 (D-) and P3 (D+) are shorted together inside power supply., Blades/Input Cord: (Order Separately), Approvals: CCC; RCM; UL 1310; ETL; CB 60601-1; S-Mark IEC/EN 60601-1; S-Mark 60950; EAC; CB 62368; Conforms to 62368-1; LPS 62368; Morocco; LVD 60335; UKCA; India BIS 5V pending; Double Insulation; Ukraine; RoHS; China RoHS; Level VI; WEEE; ETL; CE; FCC; CAN ICES-3; PSE; IP20; CB 60950;	
	Model No. GTM46161-165.0-USB	
	Part No./Ordering No. WR9QA3200USBNMEDR6W	Rev B

AGENCY ONLINE DOCUMENTS	<a href="http://www.globtek.info/certs/GTM46161/">http://www.globtek.info/certs/GTM46161/</a>
CE EC-Declaration for Medical	<a href="http://globtek.force.com/models/ec_declaration_product?id=01ta0000007drtS&amp;m=1">http://globtek.force.com/models/ec_declaration_product?id=01ta0000007drtS&amp;m=1</a>
CE EC-Declaration for Industrial/Commercial/ITE	<a href="http://globtek.force.com/models/ec_declaration_product?id=01ta0000007drtS&amp;i=2">http://globtek.force.com/models/ec_declaration_product?id=01ta0000007drtS&amp;i=2</a>
CE EC-Declaration for Household	<a href="#">Contact GloBtek for more information</a>
UKCA-Declaration for Medical	<a href="http://globtek.force.com/models/ukca_declaration_product?id=01ta0000007drtS&amp;m=1">http://globtek.force.com/models/ukca_declaration_product?id=01ta0000007drtS&amp;m=1</a>
UKCA-Declaration for Industrial/Commercial/ITE	<a href="http://globtek.force.com/models/ukca_declaration_product?id=01ta0000007drtS&amp;i=2">http://globtek.force.com/models/ukca_declaration_product?id=01ta0000007drtS&amp;i=2</a>
UKCA-Declaration for Household	<a href="#">Contact GloBtek for more information</a>
Morocco SDoC Declaration	<a href="https://globtek.secure.force.com/models/Morocco_SDoC_Declaration?id=a0Oa000000FiXUuEAN">https://globtek.secure.force.com/models/Morocco_SDoC_Declaration?id=a0Oa000000FiXUuEAN</a>
RoHS/RoHS3 Declaration	<a href="https://www.globtek.com/pdf/rohs_cert/01ta0000007drtSAAQ">https://www.globtek.com/pdf/rohs_cert/01ta0000007drtSAAQ</a>
REACH Declaration	<a href="https://www.globtek.com/pdf/iso_certificates/REACH.pdf">https://www.globtek.com/pdf/iso_certificates/REACH.pdf</a>
Conflict Minerals Declaration	<a href="https://www.globtek.com/pdf/conflict-minerals.pdf">https://www.globtek.com/pdf/conflict-minerals.pdf</a>
Prop 65 Statement	<a href="https://en.globtek.com/prop-65-statement.pdf">https://en.globtek.com/prop-65-statement.pdf</a>
IPXY rating is based on 3rd party testing and customers should check suitability and test system level IPXY rating before ordering.	

## Regulatory Certifications/Label Markings

Below follows a link to the latest regulatory certifications and marks for this specific product. National standards as well as certification schemes are constantly changing and so is the set of certification marks and symbols applicable to this product. Various standards, marks and symbols, and certificates are subject to change at any time without notice.

Additional standards or unique country certifications are available upon request. Please contact GloBtek to request a quotation.

LATEST PRODUCT/MODEL CERTIFICATIONS: <https://www.globtek.com/datasheet/w70798>

AGENCY ONLINE DOCUMENTS <http://www.globtek.info/certs/GTM46161/>



(F1) Class II / Double Insulated

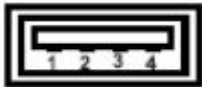

BC 1.2 compliant Dedicated Charging Port (DCP)  
This port does not support any data transfer, but is capable of supplying charge currents beyond 1.5A.  
It features a short between the D+ and D- lines.  
This type of port allows for wall chargers and car chargers with high-charge capability without the need for enumeration.

Pin 1:(+), Pin 2 (D-): Connected to Pin 3 (D+), Pin 3 (D+): Connected to Pin 2 (D-), Pin 4:(-);  
P2 (D-) and P3 (D+) are shorted together inside power supply.

GlobTek, Inc. www.globtek.com 186 Veterans Drive, Northvale, NJ 07647 Tel. (201) 784-1000 Fax (201) 784-0111	Drawing Title: GTM46161-165.0-USB, ICT / ITE / Medical Power Supply, Efficiency Level: USA DOE Level VI / Eco-design Directive 2009/125/EC, (EU) 2019/1782, Case Color/Style: GlobTek White, Wall Plug-in, Regulated Switchmode AC-DC Power Supply AC Adaptor, Input Rating: 100-240V~, 50-60 Hz, Interchangeable Blades <a href="http://en.globtek.com/interchangeable-blades.php">http://en.globtek.com/interchangeable-blades.php</a> , Output Rating: 16W, 5.0V@3.2A, Output Configuration: N/A mm, N/A/4 Cond, N/A, Type "A" USB "JACK", integral to power supply enclosure, Ferrite: None, N/A, GT Cord # C0132, Pin Out: Pin 1:(+), Pin 2 (D-): Connected to Pin 3 (D+), Pin 3 (D+): Connected to Pin 2 (D-), Pin 4:(-); P2 (D-) and P3 (D+) are shorted together inside power supply., Blades/Input Cord: (Order Separately), Approvals: CCC; RCM; UL 1310; ETL; CB 60601-1; S-Mark IEC/EN 60601-1; S-Mark 60950; EAC; CB 62368; Conforms to 62368-1; LPS 62368; Morocco; LVD 60335; UKCA; India BIS 5V pending; Double Insulation; Ukraine; RoHS; China RoHS; Level VI; WEEE; ETL; CE; FCC; CAN ICES-3; PSE; IP20; CB 60950;
	Model No. GTM46161-165.0-USB
	Part No./Ordering No. WR9QA3200USBNMEDR6W <span style="float: right;">Rev B</span>

## PACKAGING

Packing Spec P/N	Standard with USB Jack, Individually Box, User manual
Box Qty	210
Gift Box Size (mm)	74*35*42
Gift Box Color	White
Master Carton Size (mm)	544 x 375 x 151
Master Carton Cubic Volume (m³)	0.03
Master GW (Kg)	14.8 kg
BLADES INCLUDED	None: (Order Separately)
BLADE/CORD INSTALLED	None: (Order Separately)
USER MANUAL*	809-PSUQKITUSERMANUAL on A4 paper
USER MANUAL WEB LINK	<a href="https://en.globtek.com/pdf/809-PSUQKITUSERMANUAL.jpg">https://en.globtek.com/pdf/809-PSUQKITUSERMANUAL.jpg</a>

\* This specification sheet is considered the user manual for all applications. It is expected that the buyer of this product will use it to formulate their own user manual for their end product and a user manual specifically for the power adapter is not usually required. If a user manual is not specifically listed above then none will be provided with this unit.

If specific packaging is required, this section must specify all requirements and note "no exceptions". If this section does not specify packaging, it is subject to change without notice at GlobTek's discretion

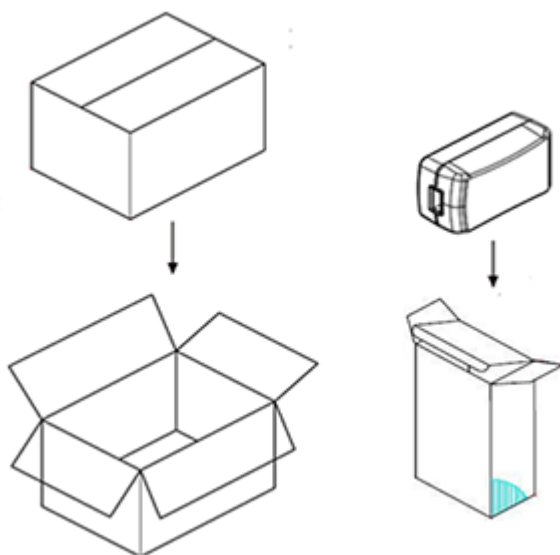

### PROPRIETARY INFORMATION

GloTek, Inc. www.globtek.com 186 Veterans Drive, Northvale, NJ 07647 Tel. (201) 784-1000 Fax (201) 784-0111	Drawing Title: GTM46161-165.0-USB, ICT / ITE / Medical Power Supply, Efficiency Level: USA DOE Level VI / Eco-design Directive 2009/125/EC, (EU) 2019/1782, Case Color/Style: GloTek White, Wall Plug-in, Regulated Switchmode AC-DC Power Supply AC Adaptor, Input Rating: 100-240V~, 50-60 Hz, Interchangeable Blades <a href="http://en.globtek.com/interchangeable-blades.php">http://en.globtek.com/interchangeable-blades.php</a> , Output Rating: 16W, 5.0V@3.2A, Output Configuration: N/A mm, N/A/4 Cond, N/A, Type "A" USB "JACK", integral to power supply enclosure, Ferrite: None, N/A, GT Cord # C0132, Pin Out: Pin 1:(+), Pin 2 (D-): Connected to Pin 3 (D+), Pin 3 (D+): Connected to Pin 2 (D-), Pin 4:(-); P2 (D-) and P3 (D+) are shorted together inside power supply., Blades/Input Cord: (Order Separately), Approvals: CCC; RCM; UL 1310; ETL; CB 60601-1; S-Mark IEC/EN 60601-1; S-Mark 60950; EAC; CB 62368; Conforms to 62368-1; LPS 62368; Morocco; LVD 60335; UKCA; India BIS 5V pending; Double Insulation; Ukraine; RoHS; China RoHS; Level VI; WEEE; ETL; CE; FCC; CAN ICES-3; PSE; IP20; CB 60950;	
	Model No. GTM46161-165.0-USB	
	Part No./Ordering No. WR9QA3200USBNMEDR6W	Rev B

## INSTRUCTIONS TO THE OEM SYSTEMS ENGINEER

It is the responsibility of the OEM systems engineer to provide the end system user instructions and warnings for the use of this product in the end system.

If an input cord is required for this product, AC Mains voltage should be provided to the power supply by a power supply cord approved to the national standards of the country in which it will be used.

This product is not designed to be repaired. No serviceable parts inside. A blown internal fuse is an indication of catastrophic failure of circuit component(s). If a Failure Analysis is required for a failed power supply/battery charger, please return the damaged unit to GloTek for an accurate determination of the root cause of the failure.

EMC Compliance of the complete OEM product, including the GloTek power supply/battery charger needs to be verified by the OEM systems engineer.

## INSTRUCTION SHEET

Q Blades Instruction Sheet (not required to be packaged with product)

Insertion Instructions: <http://www.globtek.com/pdf/Instructions-Interchangeable-Blades.pdf>

This manual is Provided to customer within the product specification - it is the responsibility of the OEM/customer to provide the end system user instructions + warnings for the use of this product in the end system. By accepting this specification the customer/OEM Agrees to these terms.

## USER MANUAL FOR Q-BLADE SERIES SWITCHING POWER SUPPLIES

Manual del Usuario. Fuentes de Alimentación Series Q-Blade

**WARNING! RISK OF FIRE! SHOCK HAZARD!:** To prevent electric shock, do not remove the cover. No user-serviceable parts inside. This unit contains hazardous voltages and should only be opened by a trained and qualified technician. Do not use if bent, cracked, modified or compromised. To avoid the possibility of electric shock, disconnect electric power to the product before connecting or disconnecting.

**Advertencia! Riesgo de Fuego! Peligro de Choque eléctrico!** No contiene dentro componentes servibles para el usuario. Desconecte el cable de alimentación antes de quitar la cubierta.

## INDOOR USE ONLY!

Únicamente para uso en el interior.

**POWER SUPPLY BLADE/CORD:** AC Mains voltage should be provided to the power supply by a power supply cords approved to the national standards in which it will be used. Please use the below table as a guideline for Suitable Power cords.

GlobTek, Inc. www.globtek.com 186 Veterans Drive, Northvale, NJ 07647 Tel. (201) 784-1000 Fax (201) 784-0111	Drawing Title: GTM46161-165.0-USB, ICT / ITE / Medical Power Supply, Efficiency Level: USA DOE Level VI / Eco-design Directive 2009/125/EC, (EU) 2019/1782, Case Color/Style: GlobTek White, Wall Plug-in, Regulated Switchmode AC-DC Power Supply AC Adaptor, Input Rating: 100-240V~, 50-60 Hz, Interchangeable Blades <a href="http://en.globtek.com/interchangeable-blades.php">http://en.globtek.com/interchangeable-blades.php</a> , Output Rating: 16W, 5.0V@3.2A, Output Configuration: N/A mm, N/A/4 Cond, N/A, Type "A" USB "JACK", integral to power supply enclosure, Ferrite: None, N/A, GT Cord # C0132, Pin Out: Pin 1:(+), Pin 2 (D-): Connected to Pin 3 (D+), Pin 3 (D+): Connected to Pin 2 (D-), Pin 4:(-); P2 (D-) and P3 (D+) are shorted together inside power supply., Blades/Input Cord: (Order Separately), Approvals: CCC; RCM; UL 1310; ETL; CB 60601-1; S-Mark IEC/EN 60601-1; S-Mark 60950; EAC; CB 62368; Conforms to 62368-1; LPS 62368; Morocco; LVD 60335; UKCA; India BIS 5V pending; Double Insulation; Ukraine; RoHS; China RoHS; Level VI; WEEE; ETL; CE; FCC; CAN ICES-3; PSE; IP20; CB 60950;	
	Model No. GTM46161-165.0-USB	
	Part No./Ordering No. WR9QA3200USBNMEDR6W	Rev B

CABLE DE ALIMENTACIÓN: El voltaje de la CA debe proporcionarse a la fuente de alimentación mediante los cables de alimentación aprobados conforme a las normas nacionales según las cuales será utilizada. Utilice por favor la tabla mencionada aquí abajo como guía para los cables eléctricos adecuados.

1. Class II model NEMA 1-15P AC power plug with 2 prongs, Q-NA(R)
2. Australian AS 3112 configuration: SAA 2 pins Class II, Q-SAA(R)
3. UK BS 1363 configuration: UK 2 pins Class II, Q-UK(R)
4. European CEE 7/16 configuration: Europlug 2 PINS, Class II, Q-EU(R)
5. Korean KS C8305 configuration: Q-KR(R)
6. Argentina IRAM 2073 configuration: 2 pins, Class II Q-AR(R)
7. China GR 2099 configuration: 2 pins, Class II Q-CN(R)
8. India configuration: 2 pins, Class II, Q-IN(R)
9. IEC320/C18 Inlet

FUSING: Internal fuse for Line is provided in the power supply. A blown internal fuse is an indication of catastrophic failure of circuit component(s). Repair must be performed by GlobTek, Inc. authorized personnel. Fuses must be replaced with same type and ratings per GlobTek internal documentation.

FUSIBLES: La fuente de alimentación provee un fusible interno para la línea. Un fusible interno quemado es un indicador de una falla catastrófica de los componentes del circuito. La reparación debe ser hecha por personal autorizado de GlobTek, Inc. Los fusibles se deben reemplazar por los mismos tipos y rangos que la documentación interna de GlobTek mencione.



GlobTek, Inc.  
www.globtek.com  
186 Veterans Drive,  
Northvale, NJ 07647  
Tel. (201) 784-1000  
Fax (201) 784-0111

Drawing Title: GTM46161-165.0-USB, ICT / ITE / Medical Power Supply, Efficiency Level: USA DOE Level VI / Eco-design Directive 2009/125/EC, (EU) 2019/1782, Case Color/Style: GlobTek White, Wall Plug-in, Regulated Switchmode AC-DC Power Supply AC Adaptor, Input Rating: 100-240V~, 50-60 Hz, Interchangeable Blades <http://en.globtek.com/interchangeable-blades.php>, Output Rating: 16W, 5.0V@3.2A, Output Configuration: N/A mm, N/A/4 Cond, N/A, Type "A" USB "JACK", integral to power supply enclosure, Ferrite: None, N/A, GT Cord # C0132, Pin Out: Pin 1:(+), Pin 2 (D-): Connected to Pin 3 (D+), Pin 3 (D+): Connected to Pin 2 (D-), Pin 4:(-); P2 (D-) and P3 (D+) are shorted together inside power supply., Blades/Input Cord: (Order Separately), Approvals: CCC; RCM; UL 1310; ETL; CB 60601-1; S-Mark IEC/EN 60601-1; S-Mark 60950; EAC; CB 62368; Conforms to 62368-1; LPS 62368; Morocco; LVD 60335; UKCA; India BIS 5V pending; Double Insulation; Ukraine; RoHS; China RoHS; Level VI; WEEE; ETL; CE; FCC; CAN ICES-3; PSE; IP20; CB 60950;

Model No. GTM46161-165.0-USB

Part No./Ordering No. WR9QA3200USBNMEDR6W

Rev B

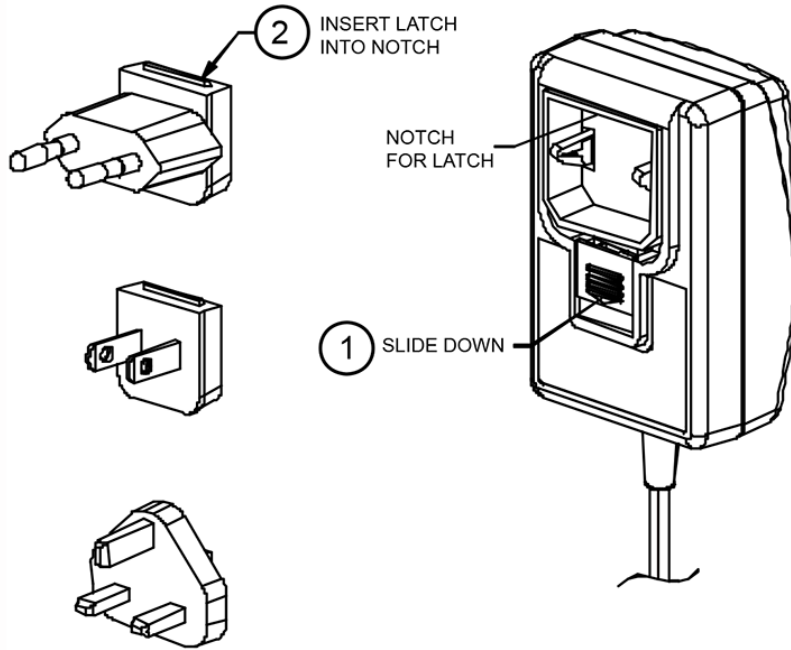

This symbol on an instrument indicates that the user should refer to the operating instructions located in the manual.

Please note:

The blades shown above are for representation of the installation process and do not indicate which AC blades are included with this power supply. Please reference the specifications "Power Supply Information" (page 2) and "Input Configuration" (page 6) for information regarding the actual blade included with this power supply, if any.

<p>GlobTek, Inc.  www.globtek.com  186 Veterans Drive,  Northvale, NJ 07647  Tel. (201) 784-1000  Fax (201) 784-0111</p>	<p>Drawing Title: GTM46161-165.0-USB, ICT / ITE / Medical Power Supply, Efficiency Level: USA DOE Level VI / Eco-design Directive 2009/125/EC, (EU) 2019/1782, Case Color/Style: GlobTek White, Wall Plug-in, Regulated Switchmode AC-DC Power Supply AC Adaptor, Input Rating: 100-240V~, 50-60 Hz, Interchangeable Blades <a href="http://en.globtek.com/interchangeable-blades.php">http://en.globtek.com/interchangeable-blades.php</a>, Output Rating: 16W, 5.0V@3.2A, Output Configuration: N/A mm, N/A/4 Cond, N/A, Type "A" USB "JACK", integral to power supply enclosure, Ferrite: None, N/A, GT Cord # C0132, Pin Out: Pin 1:(+), Pin 2 (D-): Connected to Pin 3 (D+), Pin 3 (D+): Connected to Pin 2 (D-), Pin 4:(-); P2 (D-) and P3 (D+) are shorted together inside power supply., Blades/Input Cord: (Order Separately), Approvals: CCC; RCM; UL 1310; ETL; CB 60601-1; S-Mark IEC/EN 60601-1; S-Mark 60950; EAC; CB 62368; Conforms to 62368-1; LPS 62368; Morocco; LVD 60335; UKCA; India BIS 5V pending; Double Insulation; Ukraine; RoHS; China RoHS; Level VI; WEEE; ETL; CE; FCC; CAN ICES-3; PSE; IP20; CB 60950;</p>
	<p>Model No. GTM46161-165.0-USB</p>
	<p>Part No./Ordering No. WR9QA3200USBNMEDR6W</p>
	<p>Rev B</p>

