

50-mA, 24-V, 3.2- μ A SUPPLY CURRENT, LOW-DROPOUT LINEAR REGULATOR

FEATURES

- **Controlled Baseline**
 - One Assembly Site
 - One Test Site
 - One Fabrication Site
- **Extended Temperature Performance of –55°C to 125°C**
- **Enhanced Diminishing Manufacturing Sources (DMS) Support**
- **Enhanced Product-Change Notification**
- **Qualification Pedigree⁽¹⁾**
- **24-V Maximum Input Voltage**
- **Low 3.2- μ A Quiescent Current at 50 mA**
- **Stable With Any Capacitor ($\geq 0.47 \mu\text{F}$)**
- **50-mA Low-Dropout Regulator**
- **Adjustable Output Voltage (1.2 V to 15 V)**
- **Designed to Support MSP430 Families:**
 - **1.9-V Version Ensured to be Higher Than Minimum V_{IN} of 1.8 V**
 - **2.3-V Version Ensured to Meet 2.2-V Minimum V_{IN} for Flash on MSP430F2xx**
 - **3.45-V Version Ensured to be Lower Than Maximum V_{IN} of 3.6 V**
 - **Wide Variety of Fixed Output Voltage Options to Match V_{IN} to the Minimum Required for Desired MSP430 Speed**

⁽¹⁾ Component qualification in accordance with JEDEC and industry standards to ensure reliable operation over an extended temperature range. This includes, but is not limited to, Highly Accelerated Stress Test (HAST) or biased 85/85, temperature cycle, autoclave or unbiased HAST, electromigration, bond intermetallic life, and mold compound life. Such qualification testing should not be viewed as justifying use of this component beyond specified performance and environmental limits.

- **Minimum/Maximum Specified Current Limit**
- **5-Pin SC70/SOT-323 (DCK) Package**
- **For 80-mA Rated Current and Higher Power Package, See [TPS715Axx](#)**

APPLICATIONS

- **Ultra-Low Power Microcontrollers**
- **Cellular/Cordless Handsets**
- **Portable/Battery-Powered Equipment**

DESCRIPTION

The TPS71501 low-dropout (LDO) voltage regulators offer the benefits of high input voltage, low dropout voltage, low-power operation, and miniaturized packaging. The device, which operates over an input range of 2.5 V to 24 V, is stable with any capacitor ($\geq 0.47 \mu\text{F}$). The low dropout voltage and low quiescent current allow operation at extremely low power levels. Therefore, the devices are ideal for powering battery-management ICs. Specifically, because the devices are enabled as soon as the applied voltage reaches the minimum input voltage, the output is quickly available to power continuously operating battery-charging ICs.

The usual PNP pass transistor has been replaced by a PMOS pass element. Because the PMOS pass element behaves as a low-value resistor, the low dropout voltage, typically 415 mV at 50 mA of load current, is directly proportional to the load current. The low quiescent current (3.2 μA typically) is stable over the entire range of output load current (0 mA to 50 mA).

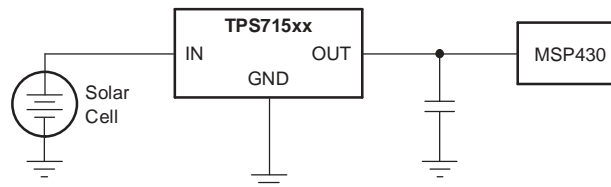
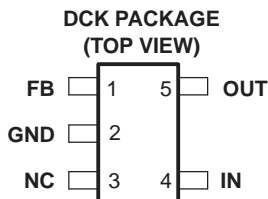

Please be aware that an important notice concerning availability, standard warranty, and use in critical applications of Texas Instruments semiconductor products and disclaimers thereto appears at the end of this data sheet.

All trademarks are the property of their respective owners.



This integrated circuit can be damaged by ESD. Texas Instruments recommends that all integrated circuits be handled with appropriate precautions. Failure to observe proper handling and installation procedures can cause damage.

ESD damage can range from subtle performance degradation to complete device failure. Precision integrated circuits may be more susceptible to damage because very small parametric changes could cause the device not to meet its published specifications.

ORDERING INFORMATION⁽¹⁾

T _J	PACKAGE ⁽²⁾		ORDERABLE PART NUMBER	TOP-SIDE MARKING
–55°C to 125°C	SC70 – DCK	Reel of 3000	TPS71501MDCKREP	CVP

- (1) For the most current package and ordering information, see the Package Option Addendum at the end of this document, or see the TI web site at www.ti.com.
- (2) Package drawings, thermal data, and symbolization are available at www.ti.com/packaging.

ABSOLUTE MAXIMUM RATINGS

over operating junction temperature range unless otherwise noted⁽¹⁾⁽²⁾

V _{IN}	Input voltage range	IN	–0.3 V to 24 V
V _{OUT}	Output voltage range	OUT	–0.3 V to 6 V
	Peak output current		Internally limited
	Continuous total power dissipation		See Dissipation Ratings Table
T _J	Junction temperature range		–55°C to 150°C
T _{stg}	Storage temperature range		–65°C to 150°C
ESD	Electrostatic discharge rating	Human-Body Model (HBM)	2000 V
		Charged-Device Model (CDM)	500 V

- (1) Stresses beyond those listed under *absolute maximum ratings* may cause permanent damage to the device. These are stress ratings only, and functional operation of the device at these or any other conditions beyond those indicated under the Electrical Characteristics is not implied. Exposure to absolute maximum rated conditions for extended periods may affect device reliability.
- (2) All voltage values are with respect to the network ground terminal.

DISSIPATION RATINGS

BOARD	PACKAGE	R _{θJC} °C/W	R _{θJA} °C/W	DERATING FACTOR ABOVE T _A = +25°C	T _A ≤ 25°C POWER RATING	T _A = 70°C POWER RATING	T _A = 85°C POWER RATING
Low-K ⁽¹⁾	DCK	165	395	2.52 mW/°C	250 mW	140 mW	100 mW
High-K ⁽²⁾	DCK	165	315	3.18 mW/°C	320 mW	175 mW	130 mW

- (1) The JEDEC Low-K (1s) board design used to derive this data was a 3-in × 3-in, two-layer board with 2-oz copper traces on top of the board.
- (2) The JEDEC High-K (2s2p) board design used to derive this data was a 3-in × 3-in, multilayer board with 1-oz internal power and ground planes and 2-oz copper traces on top and bottom of the board.

ELECTRICAL CHARACTERISTICS

Over operating junction temperature range ($T_J = -55^\circ\text{C}$ to 125°C), $V_{IN} = V_{OUT(NOM)} + 1\text{ V}$, $I_{OUT} = 1\text{ mA}$, and $C_{OUT} = 1\text{ }\mu\text{F}$ (unless otherwise noted). Typical values are at $T_J = 25^\circ\text{C}$.

PARAMETER		TEST CONDITIONS	MIN	TYP	MAX	UNIT
Input voltage ⁽¹⁾	V_{IN}	$I_O = 10\text{ mA}$	2.5		24	V
		$I_O = 50\text{ mA}$	3		24	
V_{OUT} voltage range			1.2		15	V
V_{OUT} accuracy ⁽¹⁾	Over V_{IN} , I_{OUT} , and temperature	$V_{IN} + 1.0\text{ V} \leq V_{IN} \leq 24\text{ V}$ $100\text{ }\mu\text{A} \leq I_{OUT} \leq 50\text{ mA}$	-6.25		+6.25	%
Ground pin current ⁽²⁾	I_{GND}	$0 \leq I_{OUT} \leq 50\text{ mA}$, $T_J = -40^\circ\text{C}$ to $+85^\circ\text{C}$		3.2	4.2	μA
		$0\text{ mA} \leq I_{OUT} \leq 50\text{ mA}$		3.2	4.8	
		$0\text{ mA} \leq I_{OUT} \leq 50\text{ mA}$, $V_{IN} = 24\text{ V}$			5.8	
Load regulation	$\Delta V_{OUT}/\Delta I_{OUT}$	$I_{OUT} = 100\text{ }\mu\text{A}$ to 50 mA		22		mV
Output voltage line regulation ⁽¹⁾	$\Delta V_{OUT}/\Delta V_{IN}$	$V_{OUT} + 1\text{ V} < V_{IN} \leq 24\text{ V}$		20	75	mV
Output noise voltage	V_n	$BW = 200\text{ Hz}$ to 100 kHz , $C_{OUT} = 10\text{ }\mu\text{F}$, $I_{OUT} = 50\text{ mA}$		575		μVrms
Output current limit	I_{CL}	$V_{OUT} = 0\text{ V}$, $V_{IN} \geq 3.5\text{ V}$	125		750	mA
		$V_{OUT} = 0\text{ V}$, $V_{IN} < 3.5\text{ V}$	90		750	mA
Power-supply ripple rejection	PSRR	$f = 100\text{ kHz}$, $C_{OUT} = 10\text{ }\mu\text{F}$		60		dB
Dropout voltage $V_{IN} = V_{OUT(NOM)} - 1\text{ V}$	V_{DO}	$I_{OUT} = 50\text{ mA}$		415	750	mV

(1) Minimum $V_{IN} = V_{OUT} + V_{DO}$ or the value shown for *Input voltage* in this table, whichever is greater.

(2) See [Figure 1](#). The TPS71501 employs a leakage null control circuit. This circuit is active only if output current is less than pass FET leakage current. The circuit is typically active when output load is less than $5\text{ }\mu\text{A}$, V_{IN} is greater than 18 V , and die temperature is greater than 100°C .

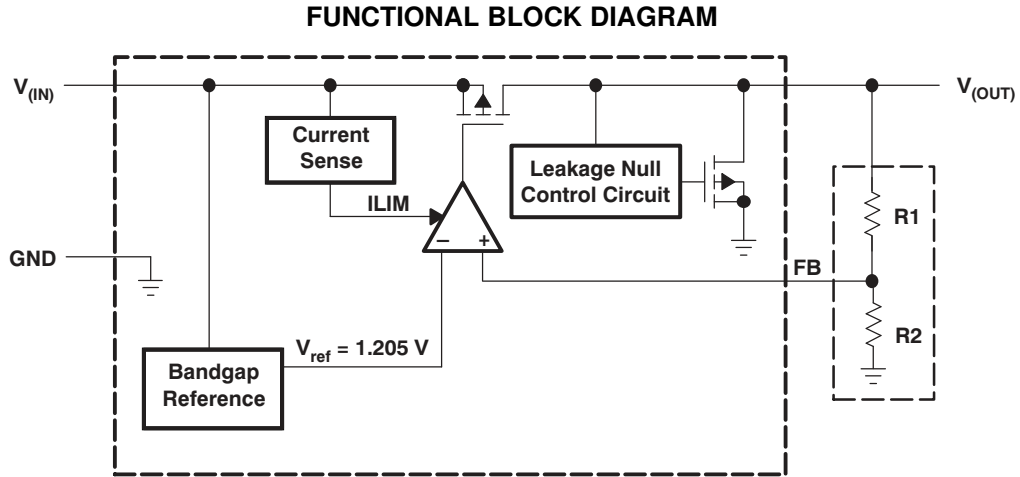

Figure 1. Functional Block Diagram

Table 1. Terminal Functions

TERMINAL		DESCRIPTION
NAME	NO.	
FB	1	Feedback. This terminal is used to set the output voltage.
GND	2	Ground
NC	3	No connection
IN	4	Input supply
OUT	5	Output of the regulator, any output capacitor $\geq 0.47 \mu\text{F}$ can be used for stability.

TYPICAL CHARACTERISTICS

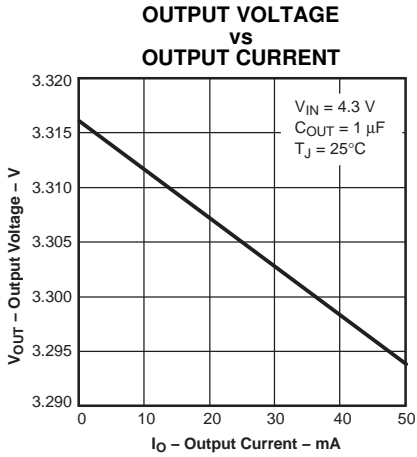

Figure 2.

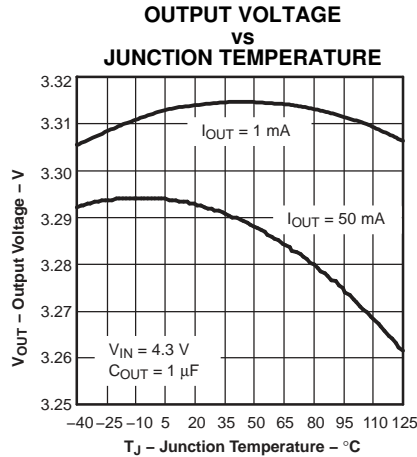

Figure 3.

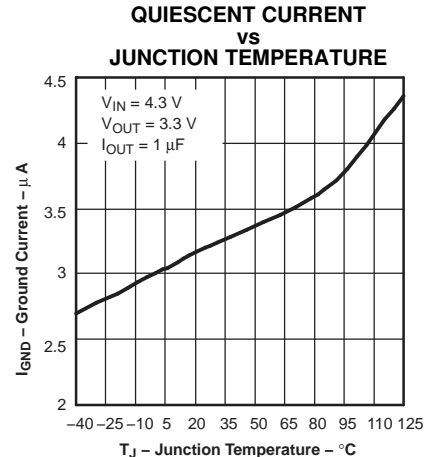

Figure 4.

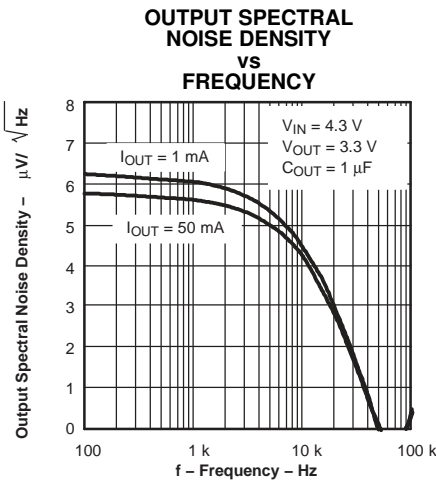

Figure 5.

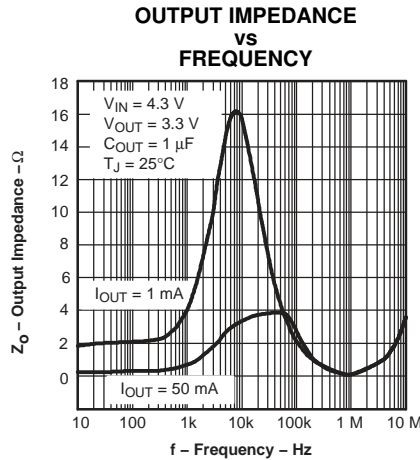

Figure 6.

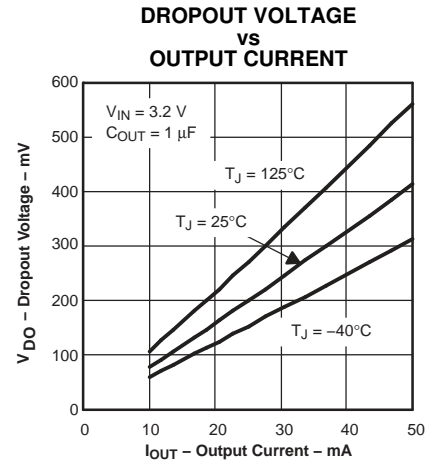

Figure 7.

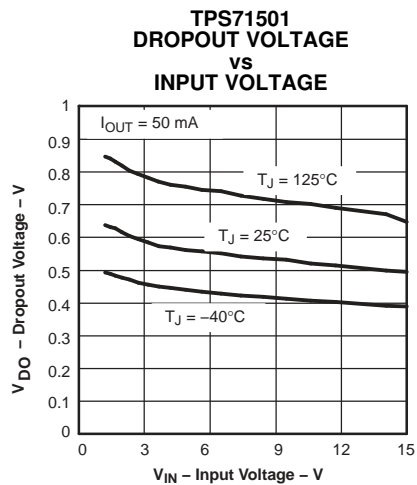

Figure 8.

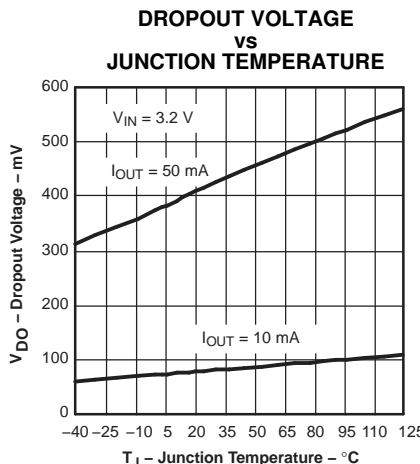

Figure 9.

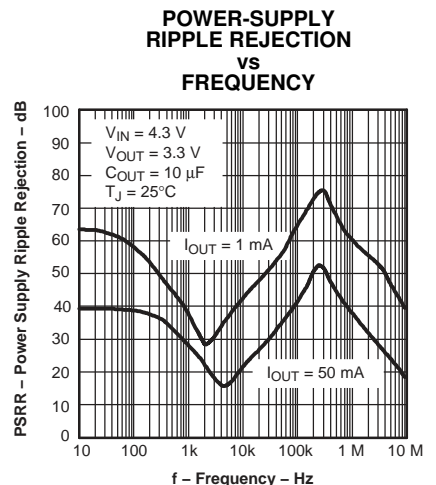

Figure 10.

TYPICAL CHARACTERISTICS (continued)

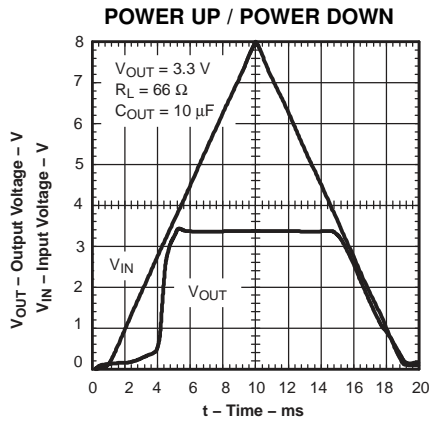

Figure 11.

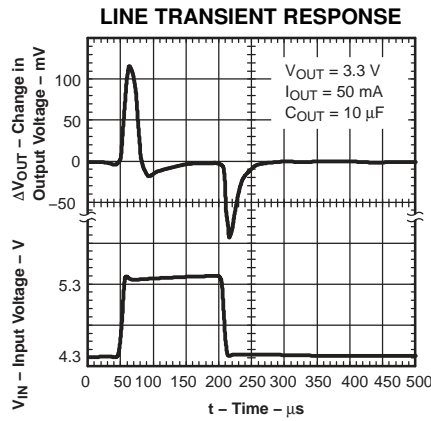

Figure 12.

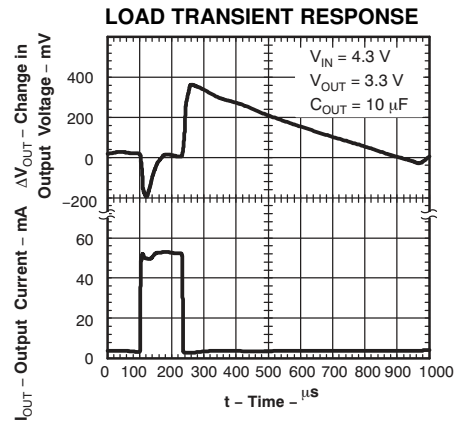

Figure 13.

APPLICATION INFORMATION

The TPS71501 LDO regulator has been optimized for ultra-low power applications such as the MSP430 microcontroller. Its ultra-low supply current maximizes efficiency at light loads, and its high input voltage range makes it suitable for supplies such as unconditioned solar panels.

External Capacitor Requirements

Although not required, a 0.047- μ F or larger input bypass capacitor, connected between IN and GND and located close to the device, is recommended to improve transient response and noise rejection of the power supply as a whole. A higher-value input capacitor may be necessary if large, fast-rise-time load transients are anticipated and the device is located several inches from the power source.

The TPS71501 requires an output capacitor connected between OUT and GND to stabilize the internal control loop. Any capacitor (including ceramic and tantalum) $\geq 0.47 \mu\text{F}$ properly stabilizes this loop. X7R type capacitors are recommended but X5R and others may be used.

Power Dissipation and Junction Temperature

To ensure reliable operation, worst-case junction temperature should not exceed +125°C. This restriction limits the power dissipation the regulator can handle in any given application. To ensure the junction temperature is within acceptable limits, calculate the maximum allowable dissipation, $P_{D(\text{max})}$, and the actual dissipation, P_D , which must be less than or equal to $P_{D(\text{max})}$.

The maximum-power-dissipation limit is determined using the following equation:

$$P_{D(\text{max})} = \frac{T_{J\text{max}} - T_A}{R_{\theta\text{JA}}} \quad (1)$$

where:

- $T_{J\text{max}}$ is the maximum allowable junction temperature.
- $R_{\theta\text{JA}}$ is the thermal resistance junction-to-ambient for the package (see the [Dissipation Ratings](#) table).
- T_A is the ambient temperature.

The regulator dissipation is calculated using:

$$P_D = (V_{\text{IN}} - V_{\text{OUT}}) \times I_{\text{OUT}} \quad (2)$$

For a higher power package version of the TPS715xx, see the [TPS715Axx](#).

Regulator Protection

The TPS71501 PMOS-pass transistor has a built-in back diode that conducts reverse current when the input voltage drops below the output voltage (e.g., during power-down). Current is conducted from the output to the input and is not internally limited. If extended reverse voltage operation is anticipated, external limiting might be appropriate.

The TPS71501 features internal current limiting. During normal operation, the TPS71501 limits output current to approximately 500 mA. When current limiting engages, the output voltage scales back linearly until the overcurrent condition ends. Take care not to exceed the power dissipation ratings of the package.

Programming the TPS71501 Adjustable LDO Regulator

The output voltage of the TPS71501 adjustable regulator is programmed using an external resistor divider as shown in Figure 14. The output voltage operating range is 1.2 V to 15 V, and is calculated using:

$$V_{OUT} = V_{REF} \times \left(1 + \frac{R1}{R2} \right) \tag{3}$$

where:

- $V_{REF} = 1.205\text{ V typ}$ (the internal reference voltage)

Resistors R1 and R2 should be chosen for approximately 1.5- μA divider current. Lower value resistors can be used for improved noise performance, but the solution consumes more power. Higher resistor values should be avoided as leakage current into/out of FB across R1/R2 creates an offset voltage that artificially increases/decreases the feedback voltage and thus erroneously decreases/increases V_{OUT} . The recommended design procedure is to choose $R2 = 1\text{ M}\Omega$ to set the divider current at 1.5 μA , and then calculate R1 using Equation 4:

$$R1 = \left(\frac{V_{OUT}}{V_{REF}} - 1 \right) \times R2 \tag{4}$$

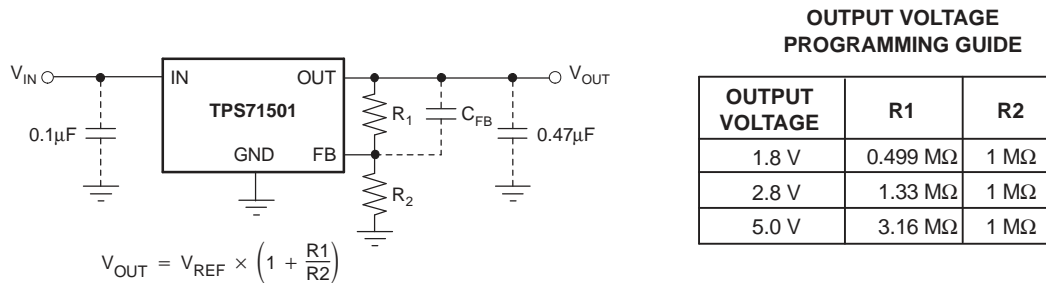

Figure 14. TPS71501 Adjustable LDO Regulator Programming

Power the MSP430 Microcontroller

Several versions of the TPS715xx are ideal for powering the MSP430 microcontroller. Table 2 shows potential applications of some voltage versions.

Table 2. Typical MSP430 Applications

DEVICE	V_{OUT} (TYP)	APPLICATION
TPS71519	1.9 V	$V_{OUT, MIN} > 1.800\text{ V}$ required by many MSP430s. Allows lowest power consumption operation.
TPS71523	2.3 V	$V_{OUT, MIN} > 2.200\text{ V}$ required by some MSP430s FLASH operation.
TPS71530	3.0 V	$V_{OUT, MIN} > 2.700\text{ V}$ required by some MSP430s FLASH operation.
TPS715345	3.45 V	$V_{OUT, MIN} < 3.600\text{ V}$ required by some MSP430s. Allows highest speed operation.

The TPS715xx family offers many output voltage versions to allow designers to minimize the supply voltage for the processing speed required of the MSP430. This minimizes the supply current consumed by the MSP430.

PACKAGING INFORMATION

Orderable Device	Status (1)	Package Type	Package Drawing	Pins	Package Qty	Eco Plan (2)	Lead finish/ Ball material (6)	MSL Peak Temp (3)	Op Temp (°C)	Device Marking (4/5)	Samples
TPS71501MDCKREP	LIFEBUY	SC70	DCK	5	3000	RoHS & Green	NIPDAUAG	Level-1-260C-UNLIM	-55 to 125	CVP	
V62/08619-01XE	LIFEBUY	SC70	DCK	5	3000	RoHS & Green	NIPDAUAG	Level-1-260C-UNLIM	-55 to 125	CVP	

(1) The marketing status values are defined as follows:

ACTIVE: Product device recommended for new designs.

LIFEBUY: TI has announced that the device will be discontinued, and a lifetime-buy period is in effect.

NRND: Not recommended for new designs. Device is in production to support existing customers, but TI does not recommend using this part in a new design.

PREVIEW: Device has been announced but is not in production. Samples may or may not be available.

OBSOLETE: TI has discontinued the production of the device.

(2) **RoHS:** TI defines "RoHS" to mean semiconductor products that are compliant with the current EU RoHS requirements for all 10 RoHS substances, including the requirement that RoHS substance do not exceed 0.1% by weight in homogeneous materials. Where designed to be soldered at high temperatures, "RoHS" products are suitable for use in specified lead-free processes. TI may reference these types of products as "Pb-Free".

RoHS Exempt: TI defines "RoHS Exempt" to mean products that contain lead but are compliant with EU RoHS pursuant to a specific EU RoHS exemption.

Green: TI defines "Green" to mean the content of Chlorine (Cl) and Bromine (Br) based flame retardants meet JS709B low halogen requirements of <=1000ppm threshold. Antimony trioxide based flame retardants must also meet the <=1000ppm threshold requirement.

(3) MSL, Peak Temp. - The Moisture Sensitivity Level rating according to the JEDEC industry standard classifications, and peak solder temperature.

(4) There may be additional marking, which relates to the logo, the lot trace code information, or the environmental category on the device.

(5) Multiple Device Markings will be inside parentheses. Only one Device Marking contained in parentheses and separated by a "~" will appear on a device. If a line is indented then it is a continuation of the previous line and the two combined represent the entire Device Marking for that device.

(6) Lead finish/Ball material - Orderable Devices may have multiple material finish options. Finish options are separated by a vertical ruled line. Lead finish/Ball material values may wrap to two lines if the finish value exceeds the maximum column width.

Important Information and Disclaimer:The information provided on this page represents TI's knowledge and belief as of the date that it is provided. TI bases its knowledge and belief on information provided by third parties, and makes no representation or warranty as to the accuracy of such information. Efforts are underway to better integrate information from third parties. TI has taken and continues to take reasonable steps to provide representative and accurate information but may not have conducted destructive testing or chemical analysis on incoming materials and chemicals. TI and TI suppliers consider certain information to be proprietary, and thus CAS numbers and other limited information may not be available for release.

In no event shall TI's liability arising out of such information exceed the total purchase price of the TI part(s) at issue in this document sold by TI to Customer on an annual basis.

TAPE AND REEL INFORMATION

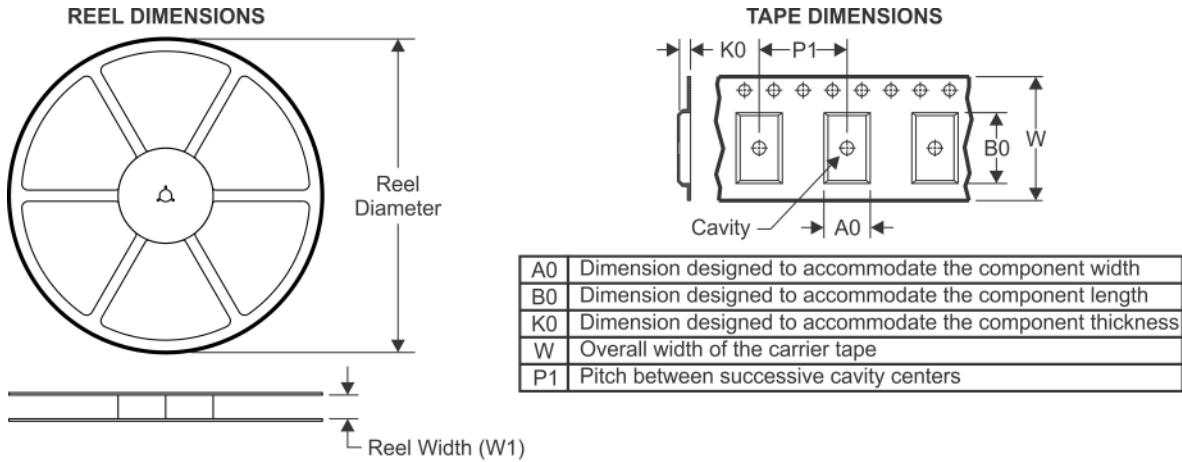

QUADRANT ASSIGNMENTS FOR PIN 1 ORIENTATION IN TAPE

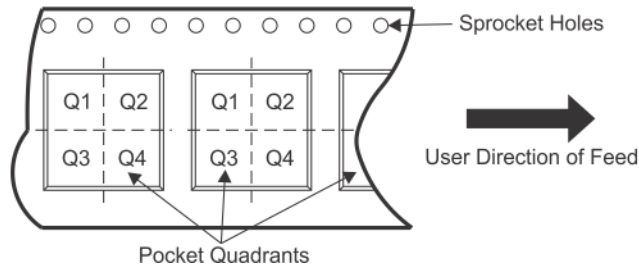

*All dimensions are nominal

Device	Package Type	Package Drawing	Pins	SPQ	Reel Diameter (mm)	Reel Width W1 (mm)	A0 (mm)	B0 (mm)	K0 (mm)	P1 (mm)	W (mm)	Pin1 Quadrant
TPS71501MDCKREP	SC70	DCK	5	3000	180.0	8.4	2.41	2.41	1.2	4.0	8.0	Q3

TAPE AND REEL BOX DIMENSIONS



*All dimensions are nominal

Device	Package Type	Package Drawing	Pins	SPQ	Length (mm)	Width (mm)	Height (mm)
TPS71501MDCKREP	SC70	DCK	5	3000	202.0	201.0	28.0

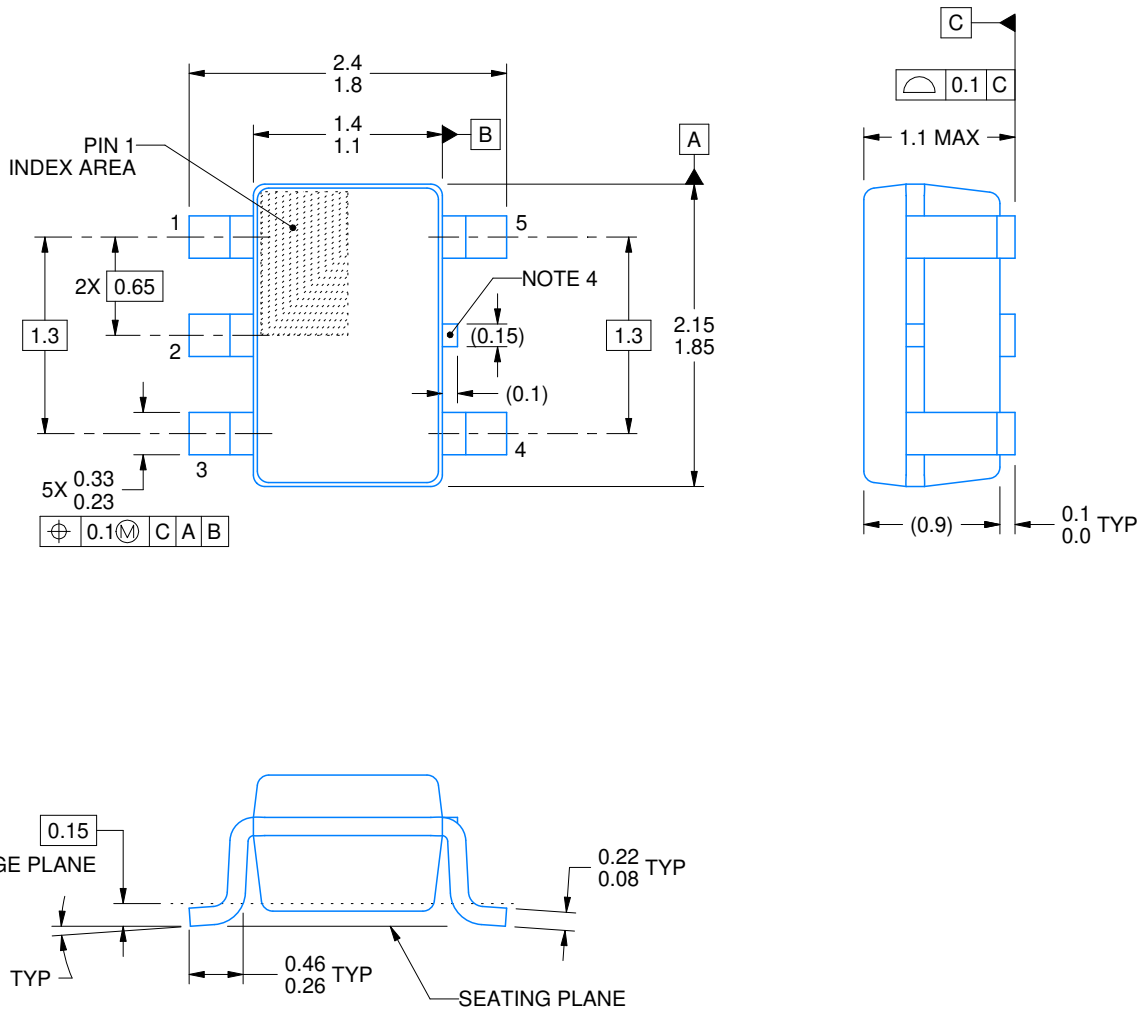

4214834/C 03/2023

NOTES:

1. All linear dimensions are in millimeters. Any dimensions in parenthesis are for reference only. Dimensioning and tolerancing per ASME Y14.5M.
2. This drawing is subject to change without notice.
3. Reference JEDEC MO-203.
4. Support pin may differ or may not be present.

EXAMPLE BOARD LAYOUT

DCK0005A

SOT - 1.1 max height

SMALL OUTLINE TRANSISTOR



LAND PATTERN EXAMPLE
EXPOSED METAL SHOWN
SCALE:18X



SOLDER MASK DETAILS

4214834/C 03/2023

NOTES: (continued)

- 4. Publication IPC-7351 may have alternate designs.
- 5. Solder mask tolerances between and around signal pads can vary based on board fabrication site.

EXAMPLE STENCIL DESIGN

DCK0005A

SOT - 1.1 max height

SMALL OUTLINE TRANSISTOR



SOLDER PASTE EXAMPLE
BASED ON 0.125 THICK STENCIL
SCALE:18X

4214834/C 03/2023

NOTES: (continued)

6. Laser cutting apertures with trapezoidal walls and rounded corners may offer better paste release. IPC-7525 may have alternate design recommendations.
7. Board assembly site may have different recommendations for stencil design.

IMPORTANT NOTICE AND DISCLAIMER

TI PROVIDES TECHNICAL AND RELIABILITY DATA (INCLUDING DATA SHEETS), DESIGN RESOURCES (INCLUDING REFERENCE DESIGNS), APPLICATION OR OTHER DESIGN ADVICE, WEB TOOLS, SAFETY INFORMATION, AND OTHER RESOURCES "AS IS" AND WITH ALL FAULTS, AND DISCLAIMS ALL WARRANTIES, EXPRESS AND IMPLIED, INCLUDING WITHOUT LIMITATION ANY IMPLIED WARRANTIES OF MERCHANTABILITY, FITNESS FOR A PARTICULAR PURPOSE OR NON-INFRINGEMENT OF THIRD PARTY INTELLECTUAL PROPERTY RIGHTS.

These resources are intended for skilled developers designing with TI products. You are solely responsible for (1) selecting the appropriate TI products for your application, (2) designing, validating and testing your application, and (3) ensuring your application meets applicable standards, and any other safety, security, regulatory or other requirements.

These resources are subject to change without notice. TI grants you permission to use these resources only for development of an application that uses the TI products described in the resource. Other reproduction and display of these resources is prohibited. No license is granted to any other TI intellectual property right or to any third party intellectual property right. TI disclaims responsibility for, and you will fully indemnify TI and its representatives against, any claims, damages, costs, losses, and liabilities arising out of your use of these resources.

TI's products are provided subject to [TI's Terms of Sale](#) or other applicable terms available either on [ti.com](https://www.ti.com) or provided in conjunction with such TI products. TI's provision of these resources does not expand or otherwise alter TI's applicable warranties or warranty disclaimers for TI products.

TI objects to and rejects any additional or different terms you may have proposed.

Mailing Address: Texas Instruments, Post Office Box 655303, Dallas, Texas 75265
Copyright © 2023, Texas Instruments Incorporated