

TAS6424-Q1 Evaluation Module

This manual describes the operations of the TAS6424Q1EVM. The TAS6424Q1EVM is a stand-alone EVM. The PurePath™ Control Console 3 GUI (PPC3) is used to initialize and operate the EVM. The main topics of this document are:

- Hardware implementation and descriptions
- Software implementation and descriptions
- TAS6424 EVM operations (hardware and software)

Required equipment and accessories:

1. TAS6424 EVM
2. USB A male to micro B male cable
3. Power Supply Unit (PSU) up to 26.4 V, > 6 A capable, if J12 is removed and 12 V is provided. If J12 is in, limit the input voltage to 18 V.
4. 1-4 resistive loads or speaker loads
5. 2-6 pair of wires stripped both ends
6. 2-mm slotted screwdriver
7. Optical audio source (optional)
8. Optical SPDIF cable (optional)
9. Desktop or laptop PC with Microsoft® Windows® 7 operating system

Contents

1	Hardware Overview.....	2
2	Hardware Overview.....	3
3	Software Overview.....	4
4	Board Layouts, Bill of Materials, and Schematic	20

List of Tables

1	TAS6424Q1EVM Bill of Materials	24
---	--------------------------------------	----

Trademarks

PurePath is a trademark of Texas Instruments.
 Microsoft, Windows are registered trademarks of Microsoft Corporation.
 All other trademarks are the property of their respective owners.

1 Hardware Overview

1.1 TAS6424E3 Evaluation Module Description

The TAS6424-Q1 EVM is a stand-alone EVM. It has single power supply input, USB control via PurePath Control Console 3 (PPC3) and two digital (I2S) audio input options. See the EVM block diagram in [Figure 1](#).

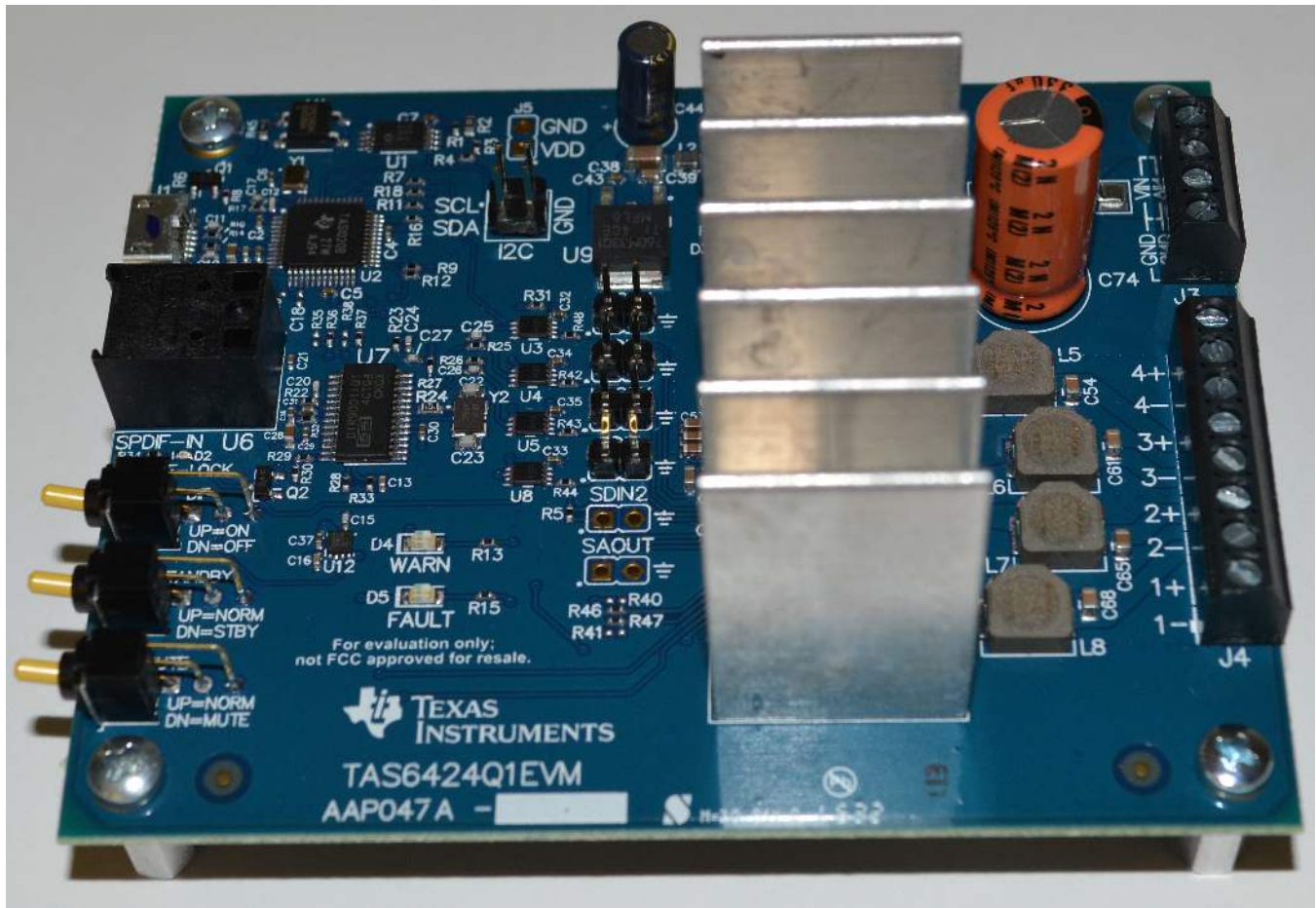
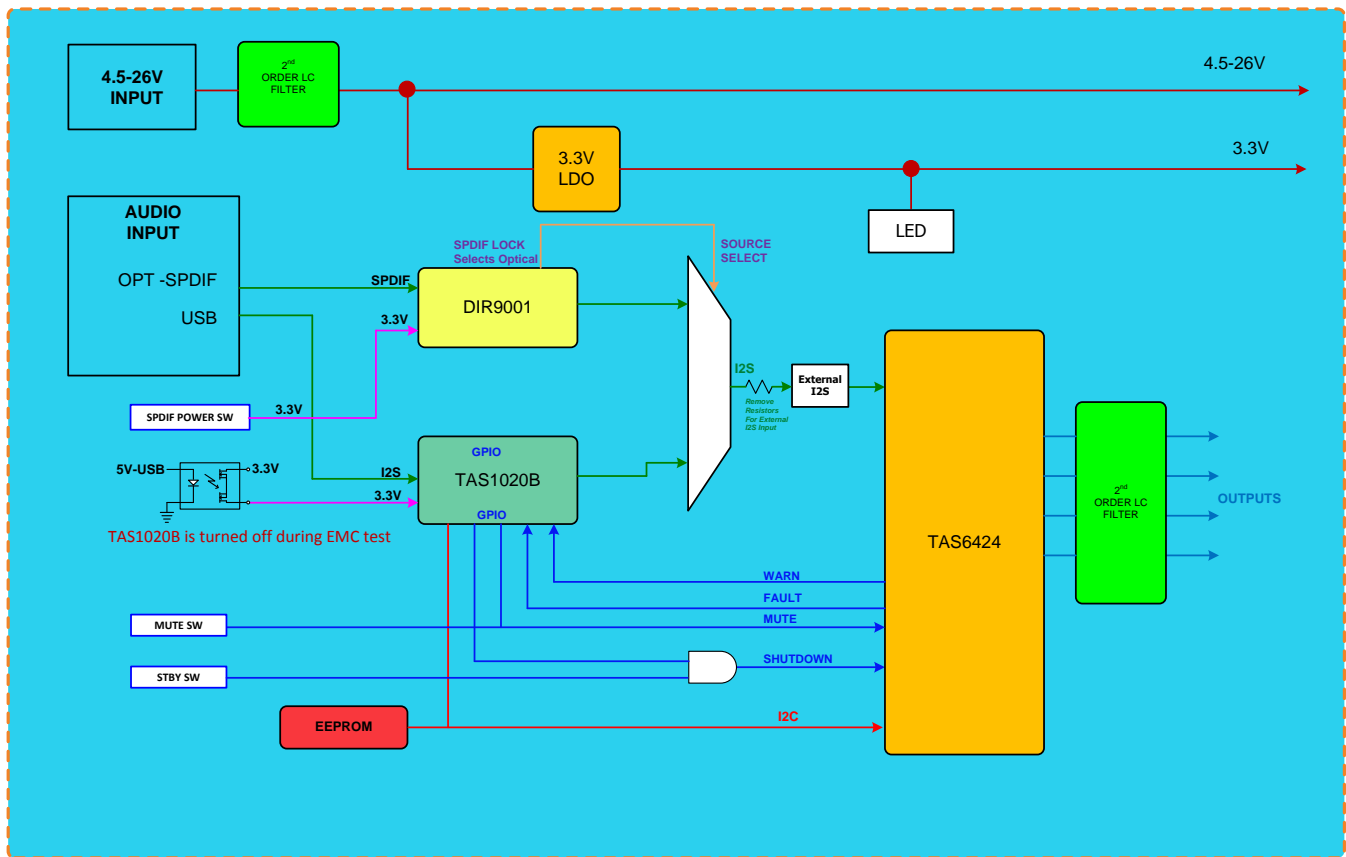

Figure 1. TAS6424-Q1 EVM

The block diagram shows the TAS6424E3 EVM signal flow.



Copyright © 2016, Texas Instruments Incorporated

Figure 2. EVM Block Diagram

2 Hardware Overview

2.1 TAS6424E3 Evaluation Module Functions

- The EVM only needs single supply to operate
- The VBAT can be separated for PVDD operation higher than 18 V
- Two audio sources can be selected readily
 1. If USB is selected, Windows Media Player can be used to stream audio.
 2. If optical is selected, an optical source such as DVD player can be used to stream audio.
 3. If external digital audio source such as Programmable Serial Interface Adapter (PSIA) from Audio Precision, series resistors on I2S signals can be removed and jumpers can be used to insert external I2S signals.
- There are three switches
 1. SPDIF power switch turns on and off optical to I2S converter.
 2. Standby switch puts the device on or out of standby.
 3. Mute switch stops or starts PWM modulation.
- USB connection also uses as a controller via I2C. The Pure Path Console 3 is the User Interface sending I2C commands to the device. PPC3 will be discussed in a later section.

3 Software Overview

3.1 PurePath™ Console 3 (PPC3) Access and Description

The PPC3 is a server-based tool. Access can be requested on <http://www.ti.com/tool/PUREPATHCONSOLE>.

Once approval is given, go to www.ti.com/mysecuresoftware to download the software. After login, the user will see this web page with a similar list of software products available for download.

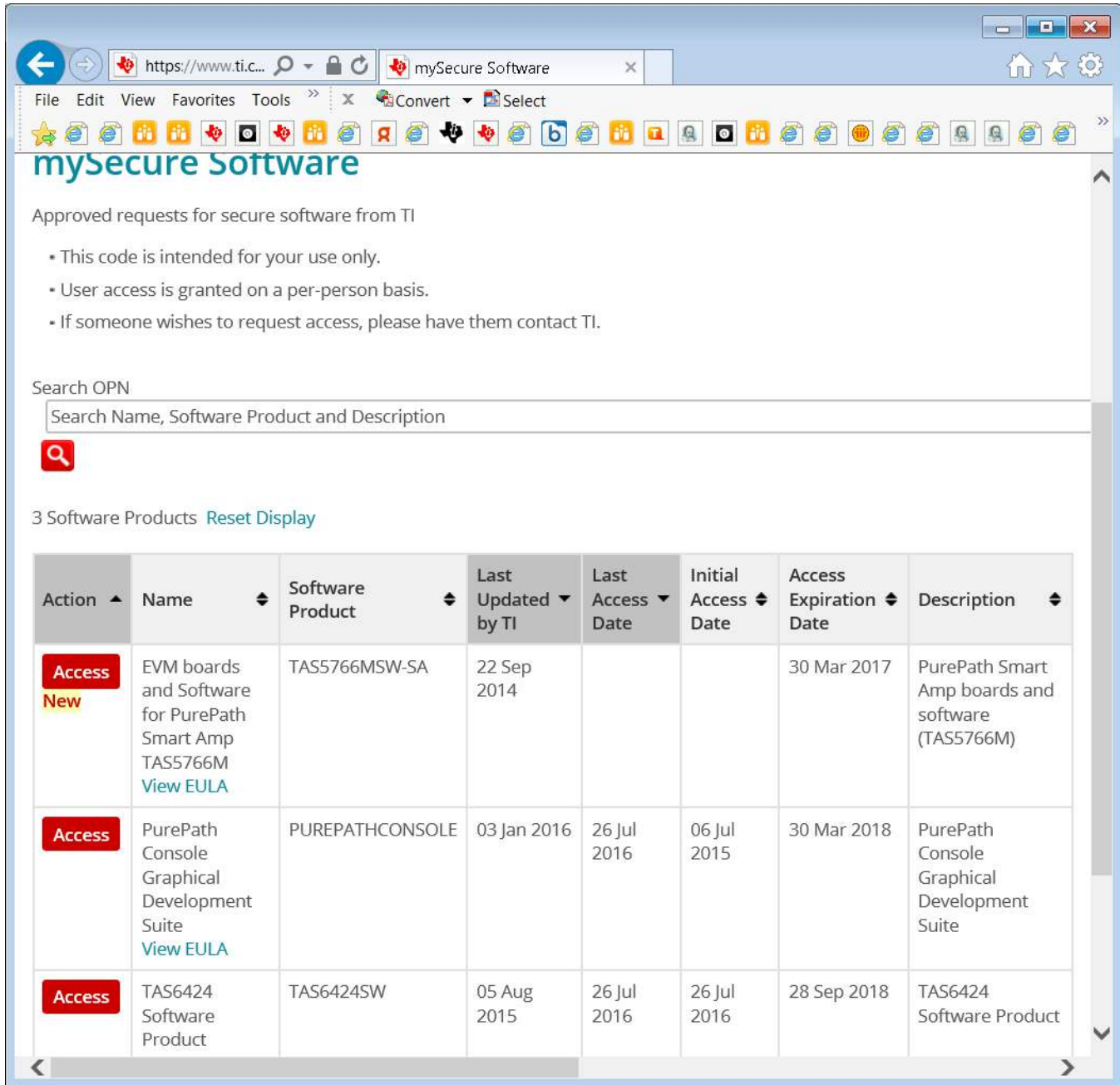

Figure 3. PPC3 Download Window

Run the installation program. Also download the PPC3 User Manual ([SLOU408](#)) for further instructions. The following window is displayed when first running PPC3.



Figure 4. PPC3 Window

When the window in [Figure 4](#) is displayed, click on “sign in” to see TAS6424 EVM application. All of the apps shown below may not be displayed for the user.

Click on TAS6424 App box to download TAS6424 application. Installation window will pop up, then click “Install”.

TAS6424 EVM box will appear in “Installed EVM Apps” section, see [Figure 5](#). Click on TAS6424 box to launch TAS6424 App.

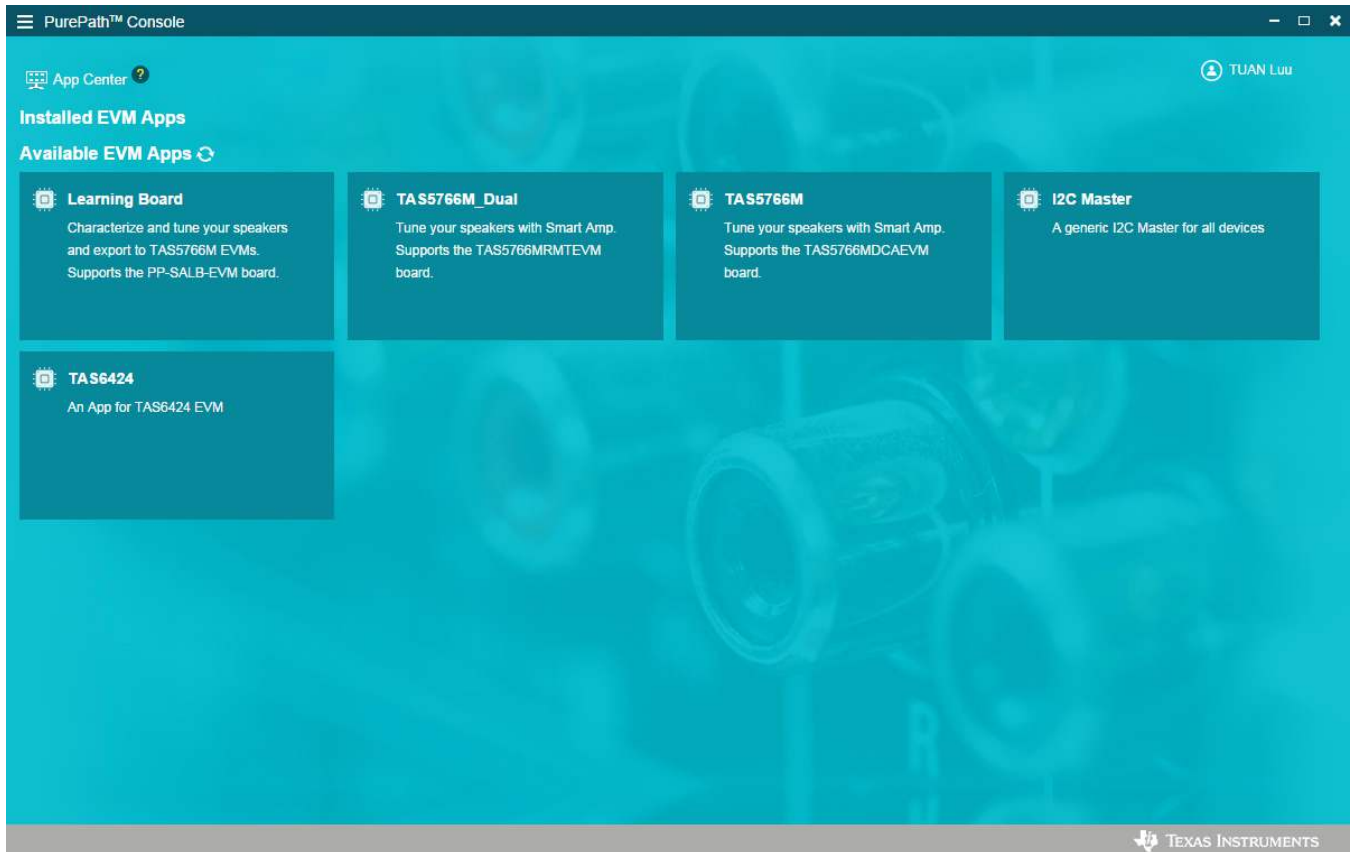

Figure 5. Available Apps Window

3.2 PurePath™ Console 3 – TAS6424 EVM Home Window

When the TAS6424 EVM PPC3 is launched, the Home Window is shown. If the EVM is powered on and the USB is connected to the PC, the Home Window will display “Connect” box in the bottom right hand corner. If the EVM is not powered on or the USB is not connected, only “TAS6424 EVM – Offline” is displayed.

Figure 6 shows the downloading progress of TAS6424 applications.

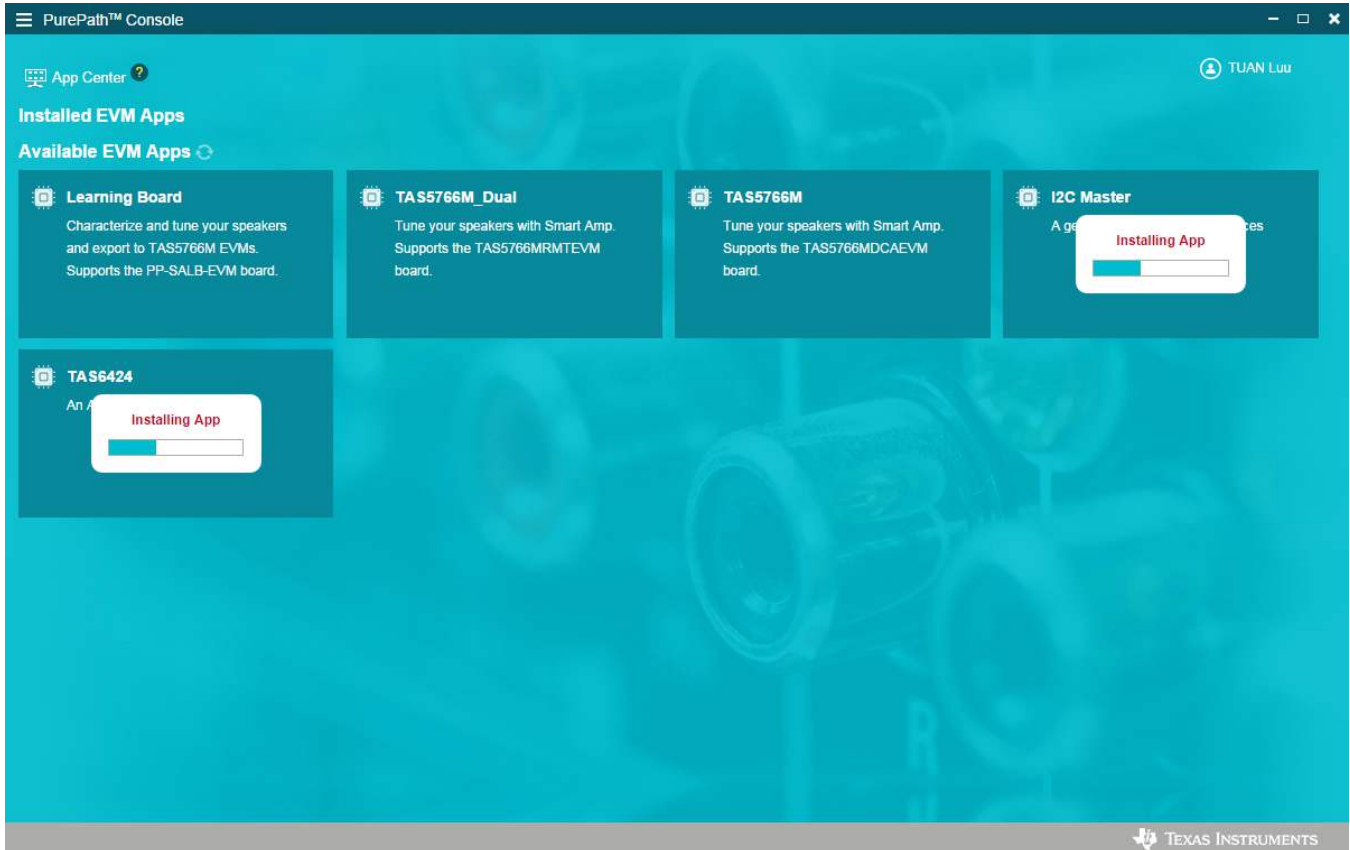

Figure 6. PPC3 Window

There are three windows available with the TAS6424 EVM PPC3: Home Window, Register Map Window and Device Monitor and Control Window.

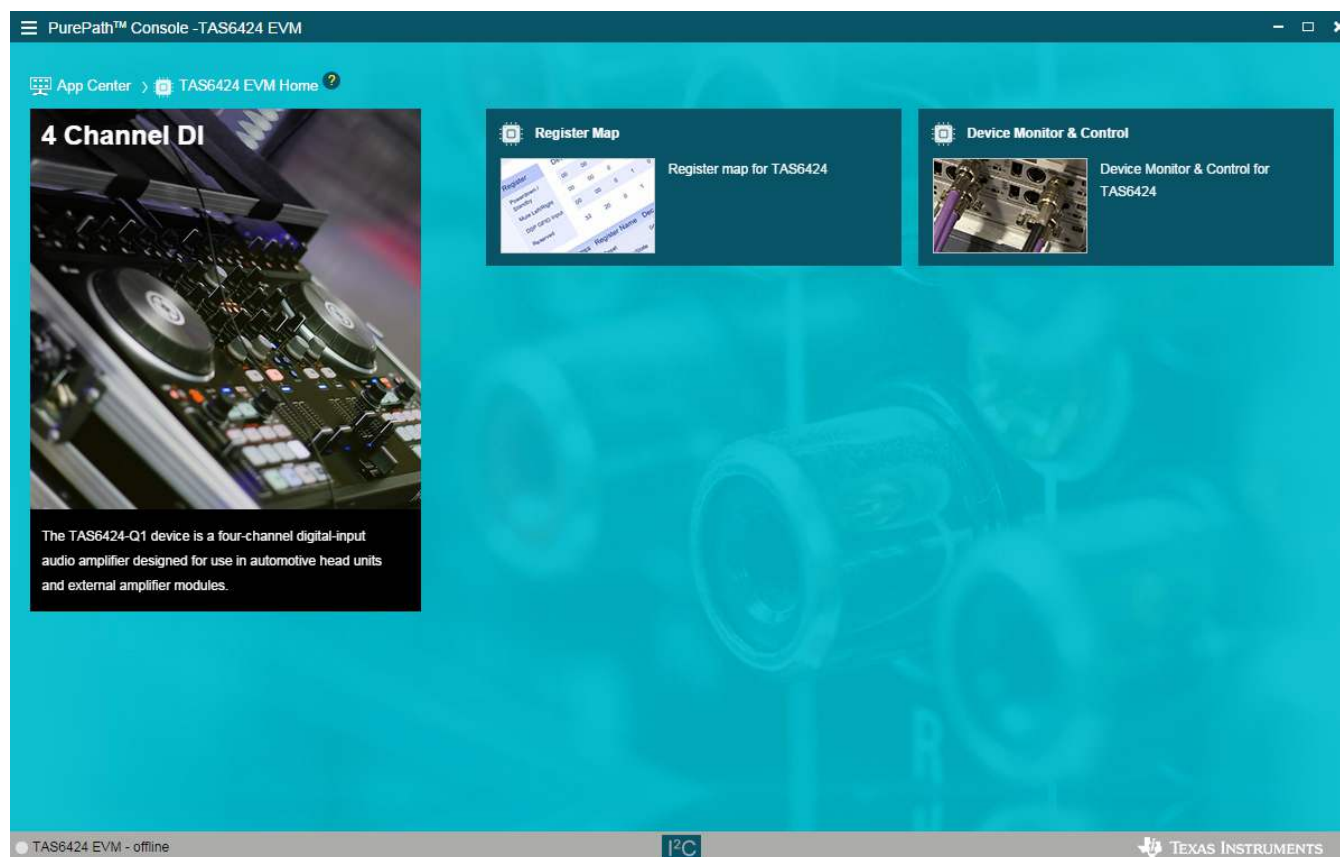

Figure 7. TAS6424 EVM Home Window

3.3 PurePath™ Console 3 – TAS6424 EVM Register Map Window

When click on Register Map Box on the Home Window, the Register Map Window is displayed. The Register Map indicates the current setting of all the registers in TAS6424.

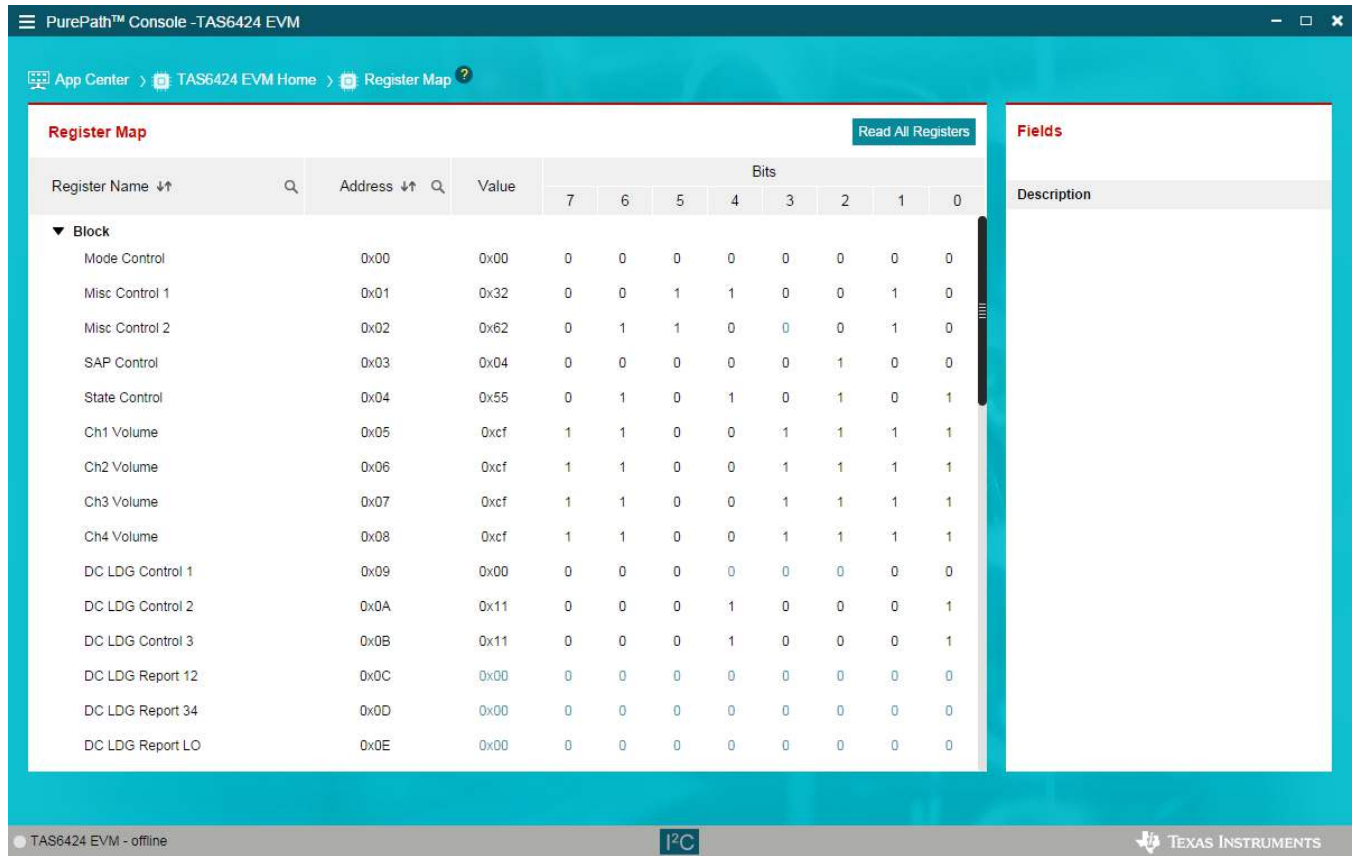

Figure 8. TAS6424 EVM Register Map Window

3.4 PurePath™ Console 3 – TAS6424 EVM Monitor and Control Window

When click on Device Monitor and Control Box on the Home Window, the Device Monitor and Control Window is displayed. The Register Map indicates the current setting of all the registers in TAS6424.

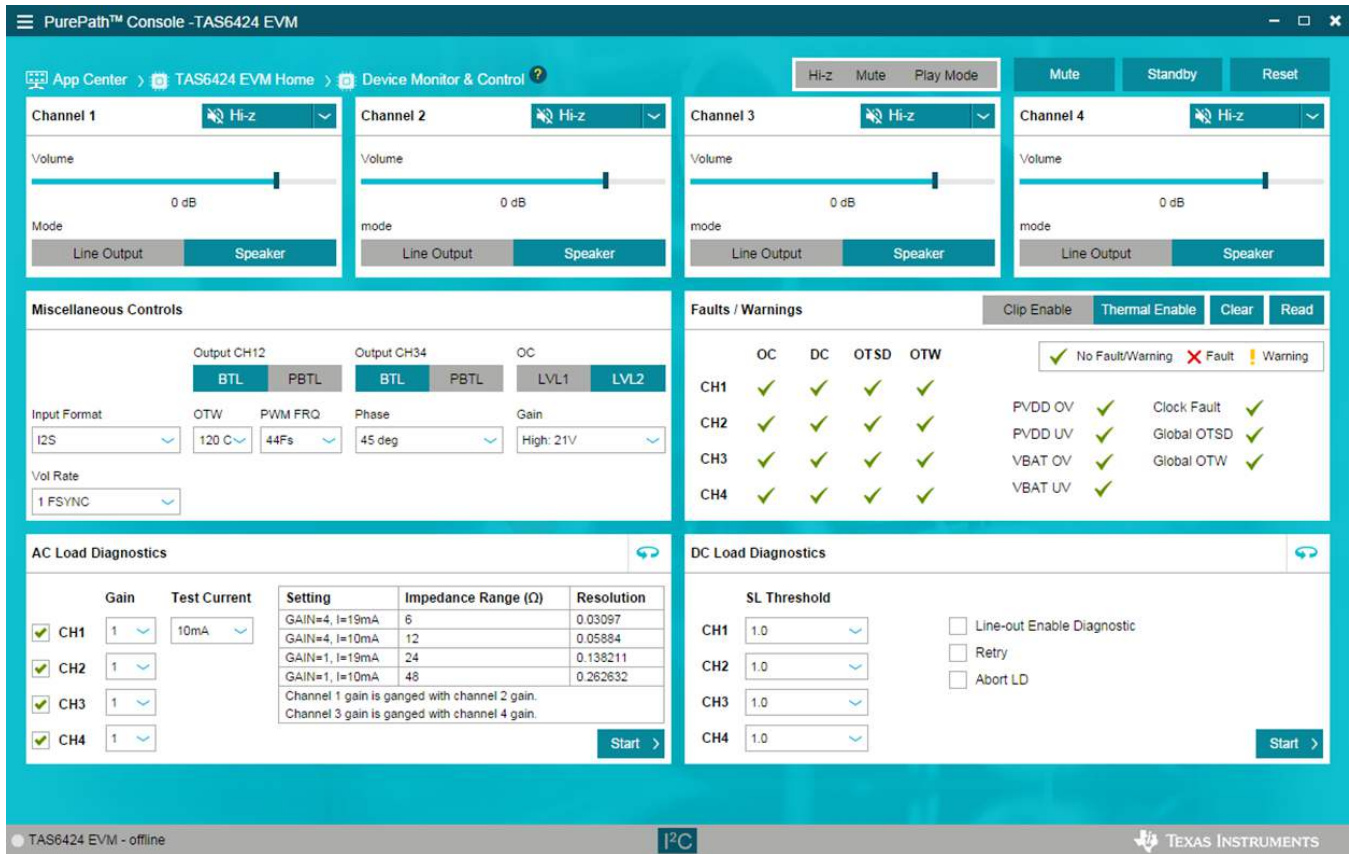

Figure 9. TAS6424 EVM Device Monitor and Control Window

3.5 TAS6424 EVM Start Up

This section describes the TAS6424 start-up procedure. Have the equipment and accessories listed on the first page of this document available.

3.5.1 TAS6424 EVM Setup

Hardware and software connections:

- Desk top or laptop PC running Windows 7. Open PPC3 GUI.
- Connect 14.4 VDC PSU to TAS6424 EVM
- Connect speakers or resistive loads to TAS6424 EVM
- Connect USB micro cable from PC to the EVM
- Set the switches (SPDIF, STANDBY, MUTE) to up positions
- Turn on the PSU
- Audio source: This can be a DVD player with optical SPDIF cable or Windows Media Player from PC
- At this point, 3.3 V LED, USB-LOCK LED and SPDIF-LOCK LED (if optical SPDIF is used) are on.
- If the SPDIF LED is not on, the default I2S input is the USB audio source.
- On the PPC3 window, launch TAS6424 EVM application
- The audio can be streamed now to the speakers. Go to the GUI and click on “Device Monitor & Control” box. Click on play button located on the top right of the window.
- The following sections describe in detail the register settings of TAS6424.

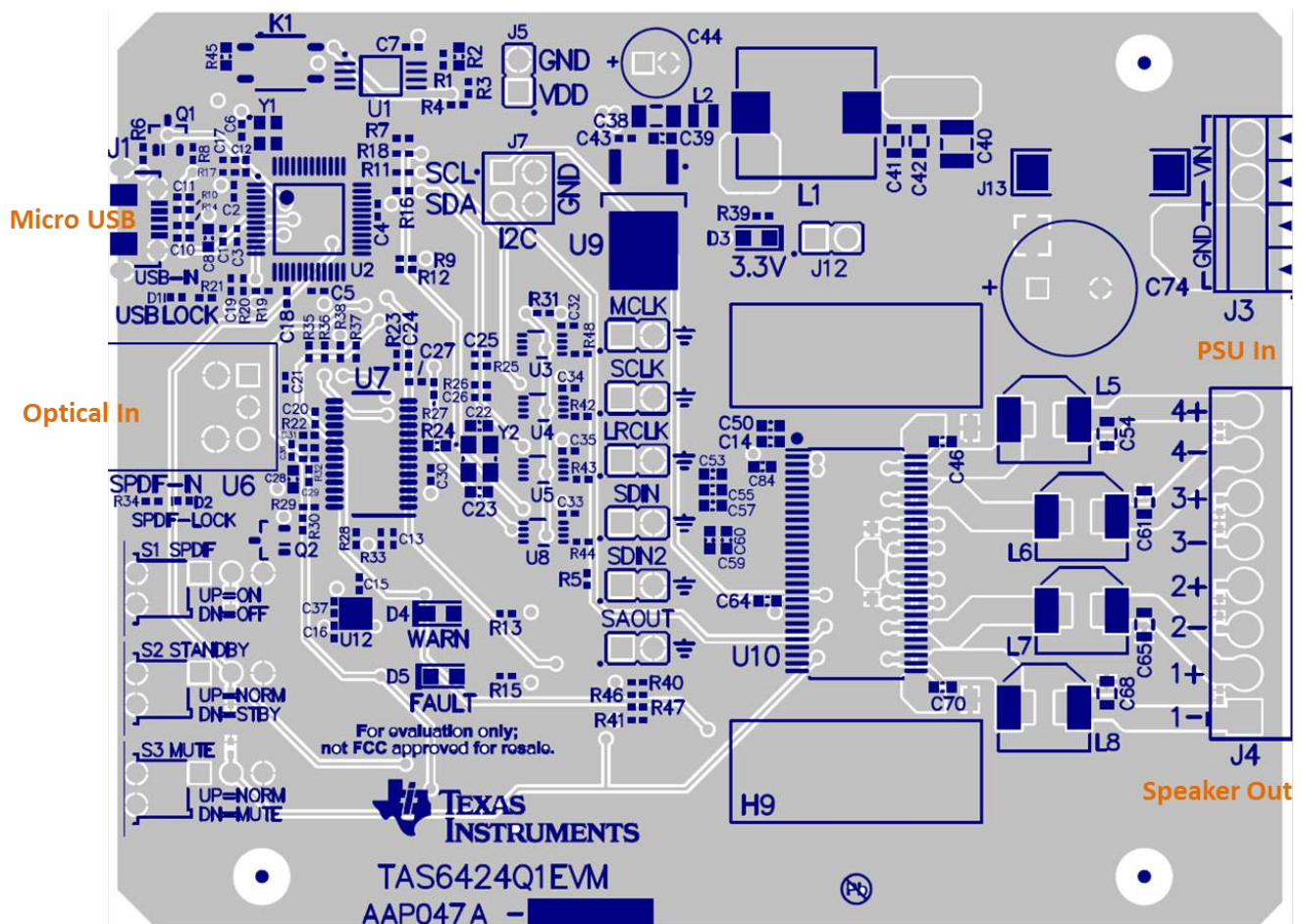

Figure 10. TAS6424 EVM Connection

3.5.2 TAS6424 Settings on Device Monitor and Control Window

The TAS6424 Register Map window is for reference. Most of the register settings are done on the Device Monitor and Control window

Click on “CONNECT” button on the bottom left corner of the TAS6424 EVM application window, see [Figure 11](#). The LED next to the TAS6424 EVM changes from gray to green and the “CONNECT” button changes to “DISCONNECT” button.

Click on the TAS6424 Device Monitor and Control box. The following window is displayed.

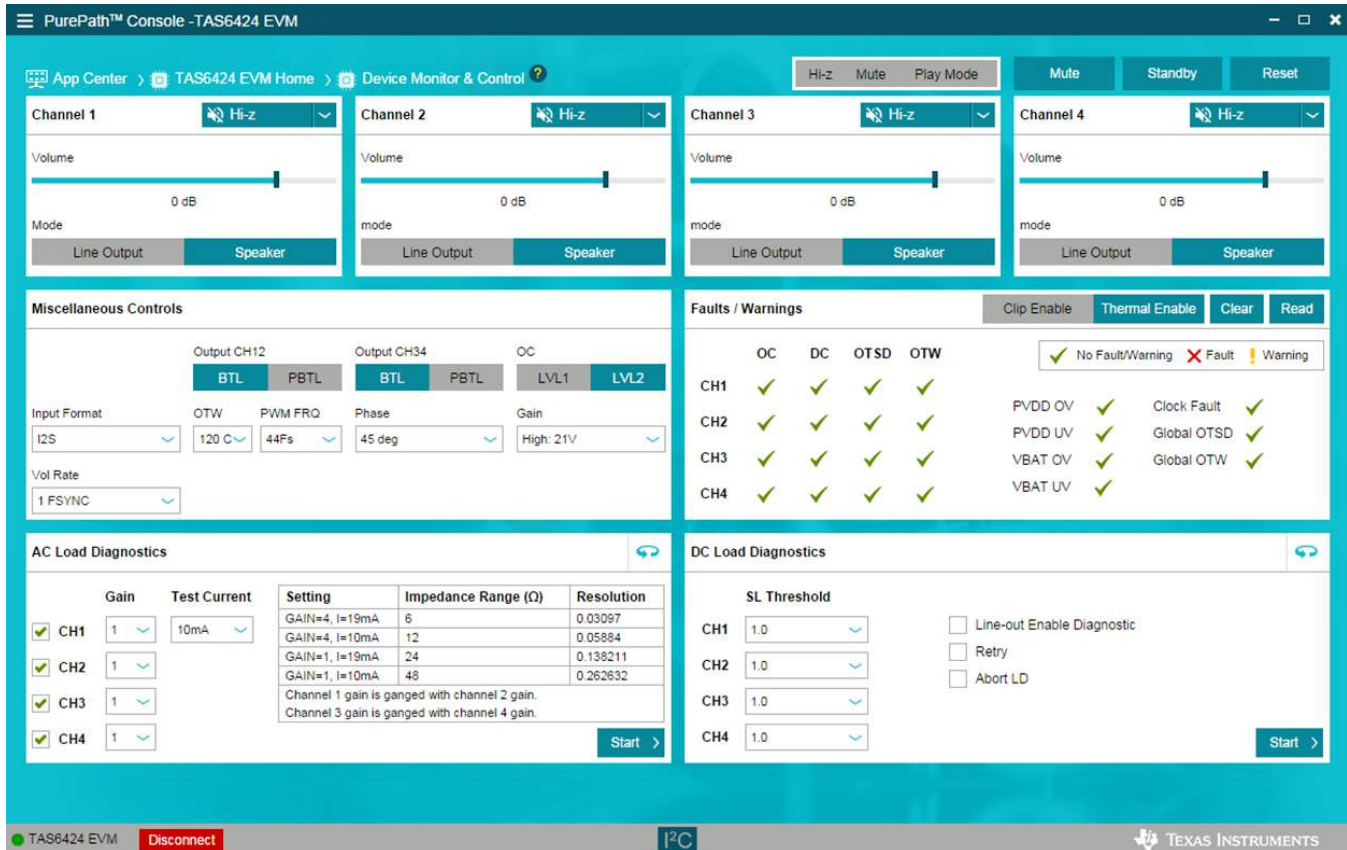

Figure 11. Device Monitor and Control Window

This window has 6 major sections: global control section, channel control section, other control section, faults and warnings section, AC load diagnostics section and DC load diagnostics section.

3.5.2.1 Global Control Section

The Hi-z, Mute and Unmute buttons with the gray background controls all 4 channels at the same time. When Hi-z is selected, all 4 channels are put in Hi-z. The display for each channel in the channel control section will reflect these buttons selections.

The Mute Pin button is the GPIO pin controlling the mute function of the device.

The Standby button is the GPIO pin controlling the standby function of the device.

The Reset button is software reset. This will put the device back in default settings.



Figure 12. Global Control Section

3.5.2.2 Channel Control Section

Each channel has the same setting selections: Hi-z, Mute, Unmute, Volume, Line-out mode and Speaker mode.

The drop down menu allows user to select either Hi-z, Mute or Unmute state of each channel.

The volume slide controls the digital gain of each channel.

The default setting for each channel is speaker mode. If line-out is used, select Line Output button.

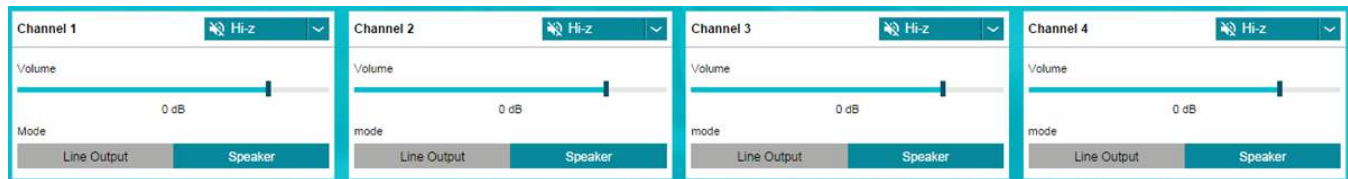

Figure 13. Channel Control Section

3.5.2.3 Miscellaneous Control Section

There are miscellaneous settings that are available on the GUI for easy access.

OSR is oversampling bit. For lower idle noise 64X OSR is set as default. For wider bandwidth, 128X OSR can be used. 64X OSR is recommended.

TAS6424 supports parallel Bridge-Tied Load. Channels 1 and 2 can be one PBTL channel and channels 3 and 4 can be the other. Before setting a set of channels to PBTL mode, connect the (+) terminals as PBTL channel (+) and the (-) terminals as PBTL channel (-). Then connect the speaker (+) to the PBTL channel (+) and connect the speaker (-) to the PBTL channel (-).

The over-current has two levels. The lower level is 1. The default is level 2. When running at lower output current, OC level can be set to 1. I2S and TDM are automatically detected. Use the pull down menu from "Input Format" box to manually select the audio format.

If sampling frequency is greater than 48 kHz, select 96 kHz from the "Input FS" pull down.

Over-temperature warning can be programmable, use the pull down menu to choose the OTW temperature. The default setting is 120°C.

The output switching frequency (FSW) or Pulse Width Modulation frequency (PWM) is set at 2.1 MHz. The pull-down menu on the PWM FRQ box is used to choose a lower FSW. LC value should be adjusted when FSW is changed.

The offset phase for each channel is set at 45 degrees. This helps lower the ripple current on the power supply as not all the channels switch at the same time. To choose a different phase offset, use the pull-down menu on the "Phase" box.

There are four gain settings in TAS6424: low, normal, high and maximum. The default setting is high. However, the recommended setting is normal for lower noise performance for driving speakers at 14.4 VDC. The gain setting is selectable via the drop down menu in the "Gain" box.

The volume slew rate is measured with sampling frequency. The default setting is 1 period of sampling frequency (FSYNC or FS). This rate is selectable from 1 to 8 sampling periods with the drop down menu under "Vol Rate" box.

Miscellaneous Controls

Output CH12

BTL

PBTL

Output CH34

BTL

PBTL

OC

LVL1

LVL2

Input Format:

OTW: PWM FRQ: Phase: Gain:

Vol Rate:

Figure 14. Other Control Section

3.5.2.4 Faults and Warnings Section

The top right buttons on this box serve as controlling and monitoring faults.

Clip enable route the clip detection bit to the warning pin. This is displayed as yellow LED on the EVM.

Thermal enable route the over-temperature warning bit to the warning pin. This is display as the same yellow LED on the EVM.

Clear button clears all the faults and warnings.

Read button manually read the faults and warnings.

Faults / Warnings				Clip Enable	Thermal Enable	Clear	Read
	OC	DC	OTSD	OTW	✓ No Fault/Warning ✗ Fault ! Warning		
CH1	✓	✓	✓	✓	PVDD OV	✓	Clock Fault
CH2	✓	✓	✓	✓	PVDD UV	✓	Global OTSD
CH3	✓	✓	✓	✓	VBAT OV	✓	Global OTW
CH4	✓	✓	✓	✓	VBAT UV	✓	

Figure 15. Faults and Warnings Section

3.5.2.5 AC Load Diagnostics Section

AC load diagnostics report speaker impedance and phase. The diagnostics can be performed with one or all four channels.

Select the correct output impedance and click start. Follow the pop up instructions to complete the load diagnostics run.

NOTE: Make sure to set the digital input to 0 dBFS (100% full-scale). If the sine wave is provided from the USB audio, turn the audio media volume and PC sound card volume to maximum.

Click on the “flip” icon located on the top right of the AC load diagnostics box to see the results.

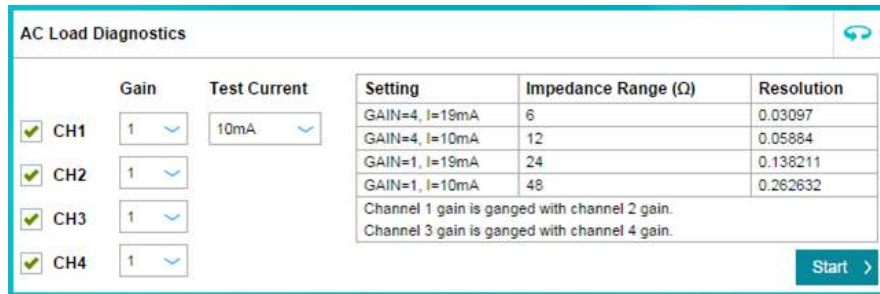

Figure 16. AC Load Diagnostics Section

3.5.2.6 DC Load Diagnostics Section

The DC load diagnostics report if a channel is short to power, short to ground, short to load or open.

Select the impedance of the load from 0.5 to 5 Ω. Click start and then click the “flip” on the top right of the box to view results.

If a channel is selected as a line-out, click on “LO ENA LD” to enable line-out load diagnostics.

“Retry” box is used when DC load diagnostics are run more than one time.

DC load diagnostics can be aborted by click on the “Abort LD” box.



Figure 17. DC Load Diagnostics Section

3.5.3 TAS6424 Settings on Register Map Window

The register map can be sorted either alphabetically or numerically (register number).

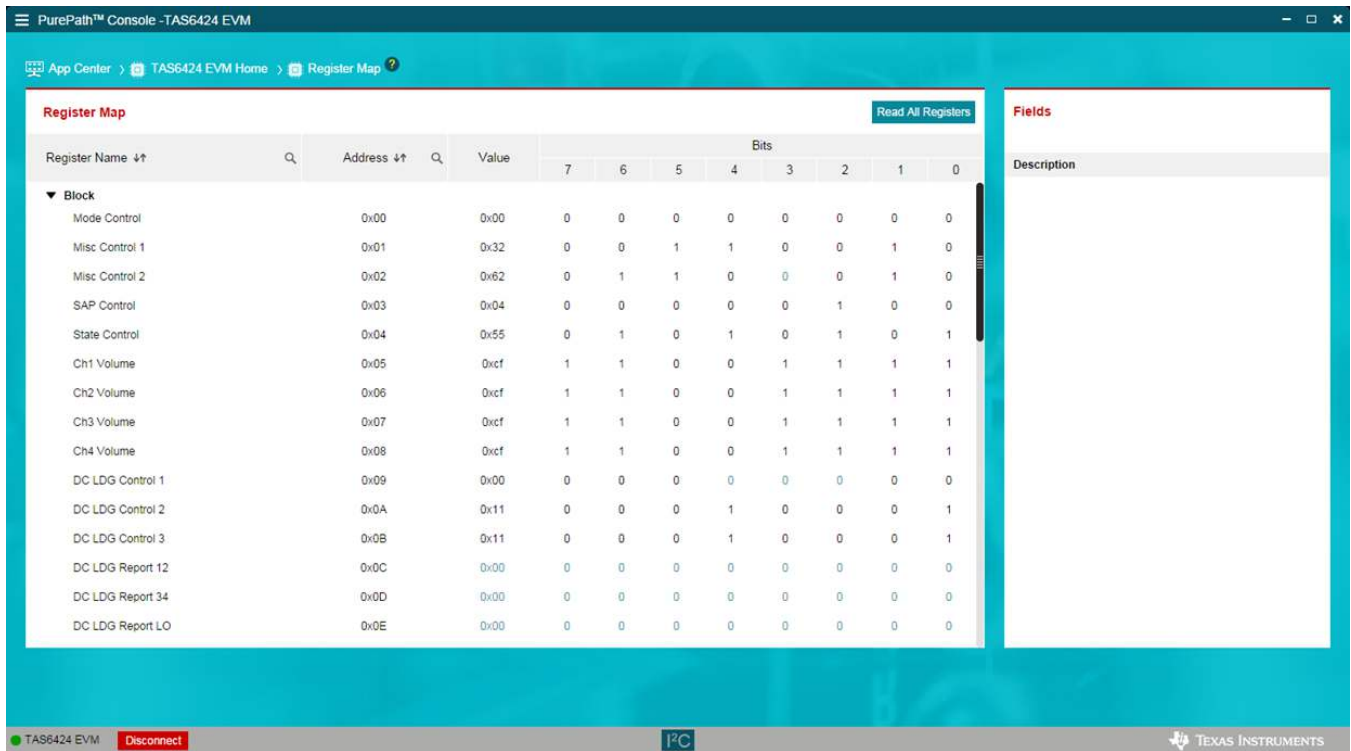

Figure 18. Register Map Window

When a register is selected, the hex value along with the individual bit value is displayed. The name and description for each bit are shown to the right in the "Fields" box.

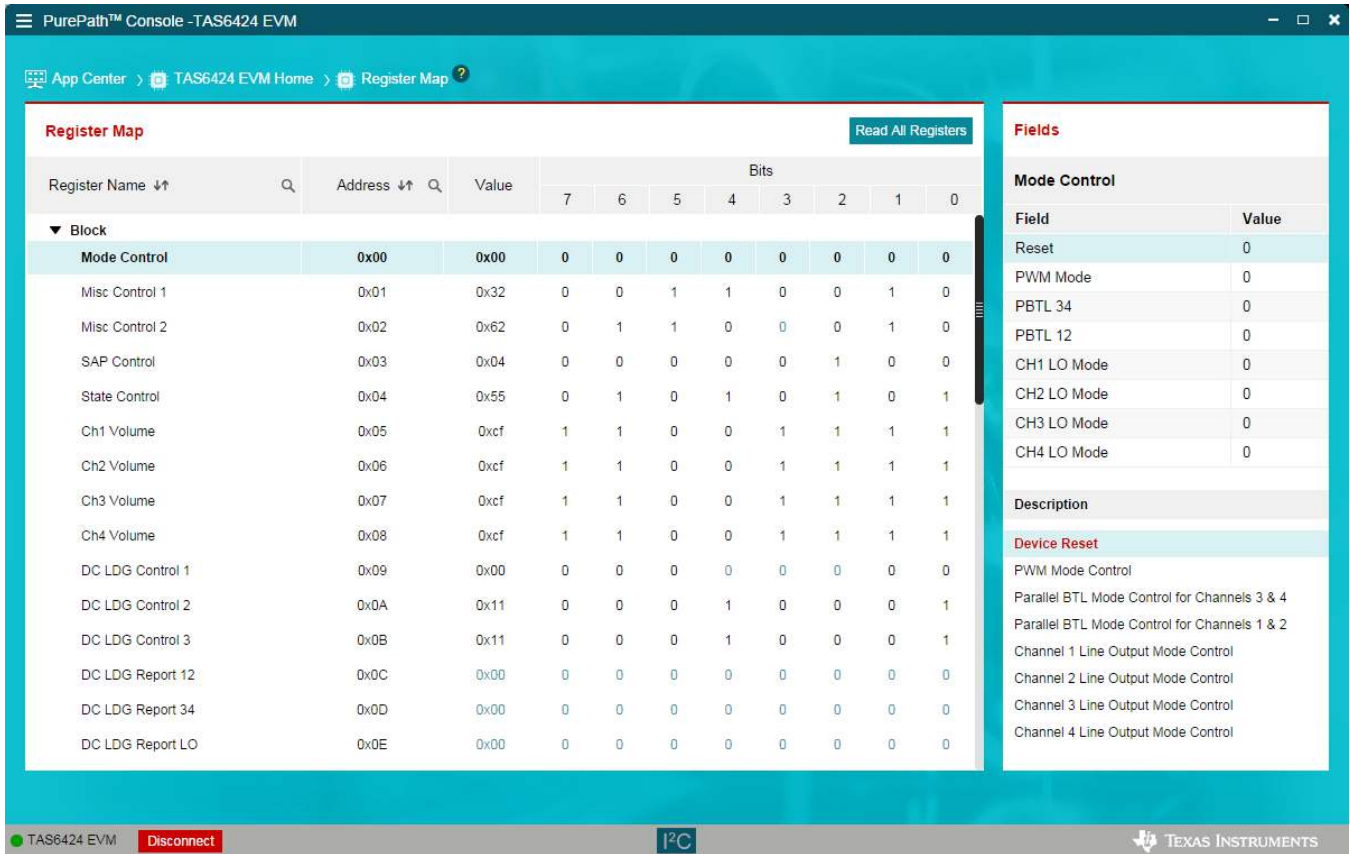

Figure 19. Register Map Window - Expanding

Double click on any bit, the bit will change state. This state is executed at the end of the click.

3.5.4 I2C Window

The PPC3 has an I2C monitor and also configuration program options.

When this window is first open, the round button is green. To record I2C commands, click on this button and it will turn red. The recording can be saved for later used by clicking the save icon.

The I2C commands can also be copied to clip board by clicking the icon next to trash bin icon.

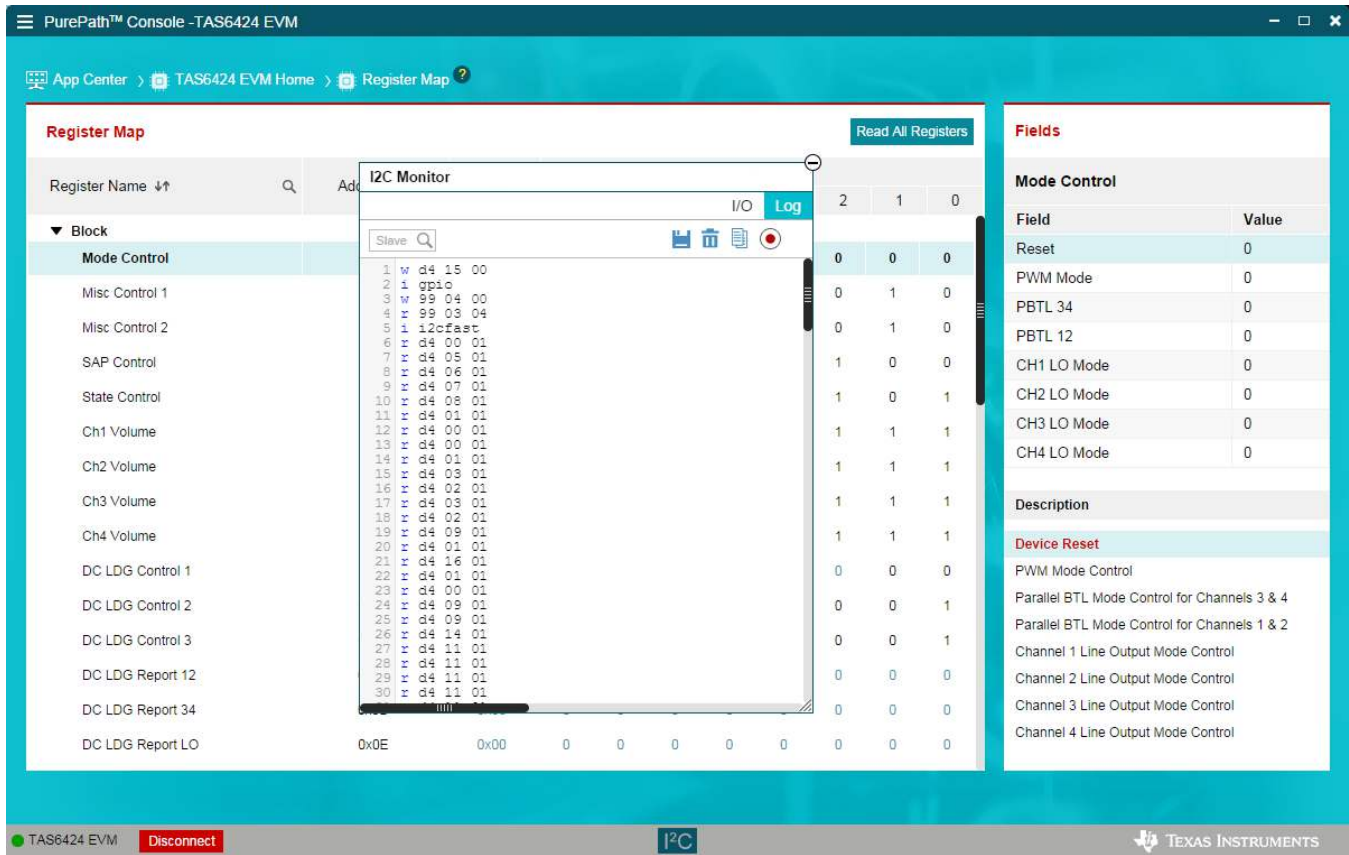

Figure 20. I2C Window – I2C Logging

A set of I2C commands can be loaded and executed from this window. On the top right corner, click on “I/O” button to display the above window. Write I2C commands here or open an existing *.cfg file then click “Execute” button on the bottom left corner. The I2C commands are sent to the device when the “Execute” button is pressed.

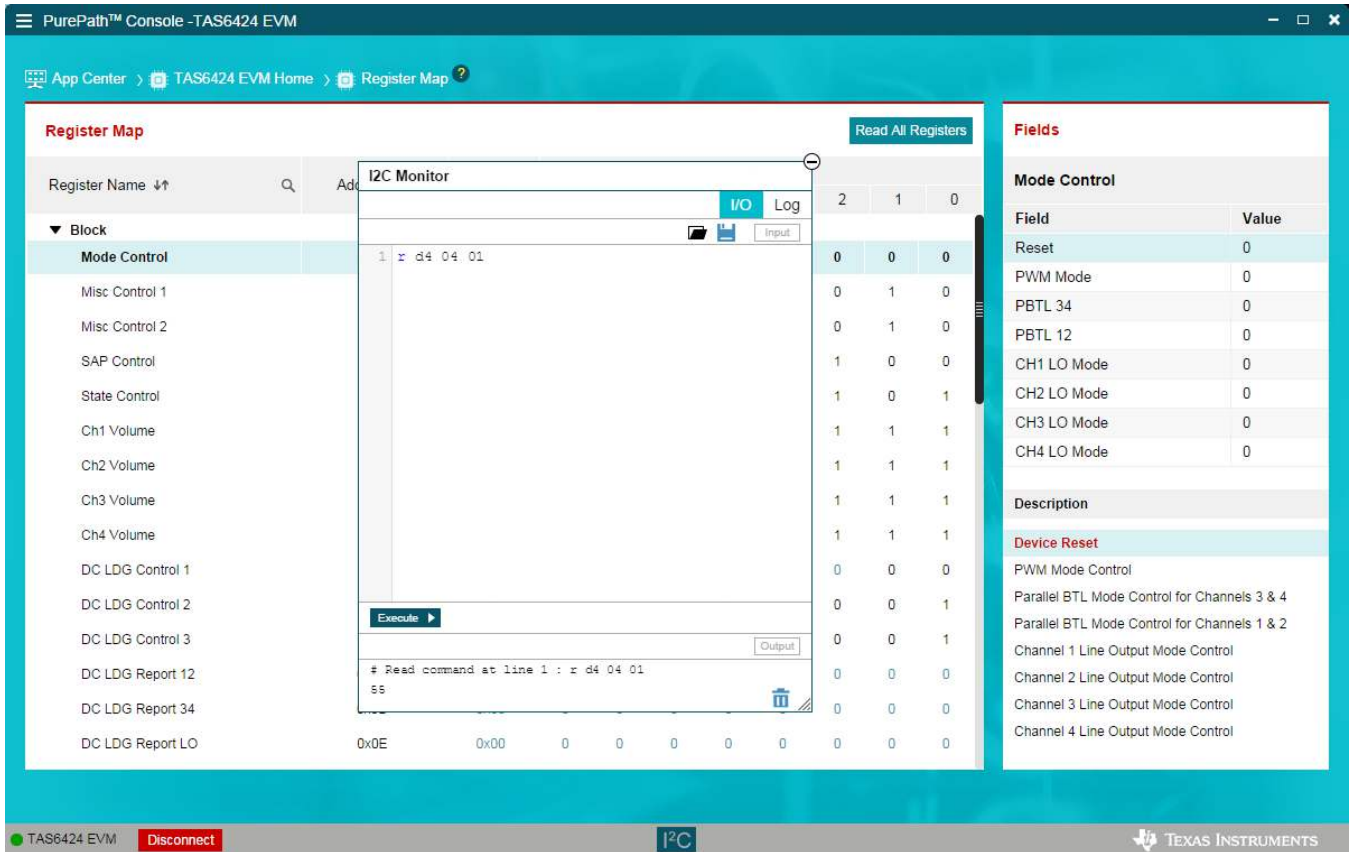

Figure 21. I2C Window – Sending I2C Commands

4 Board Layouts, Bill of Materials, and Schematic

4.1 TAS6424 EVM Layouts

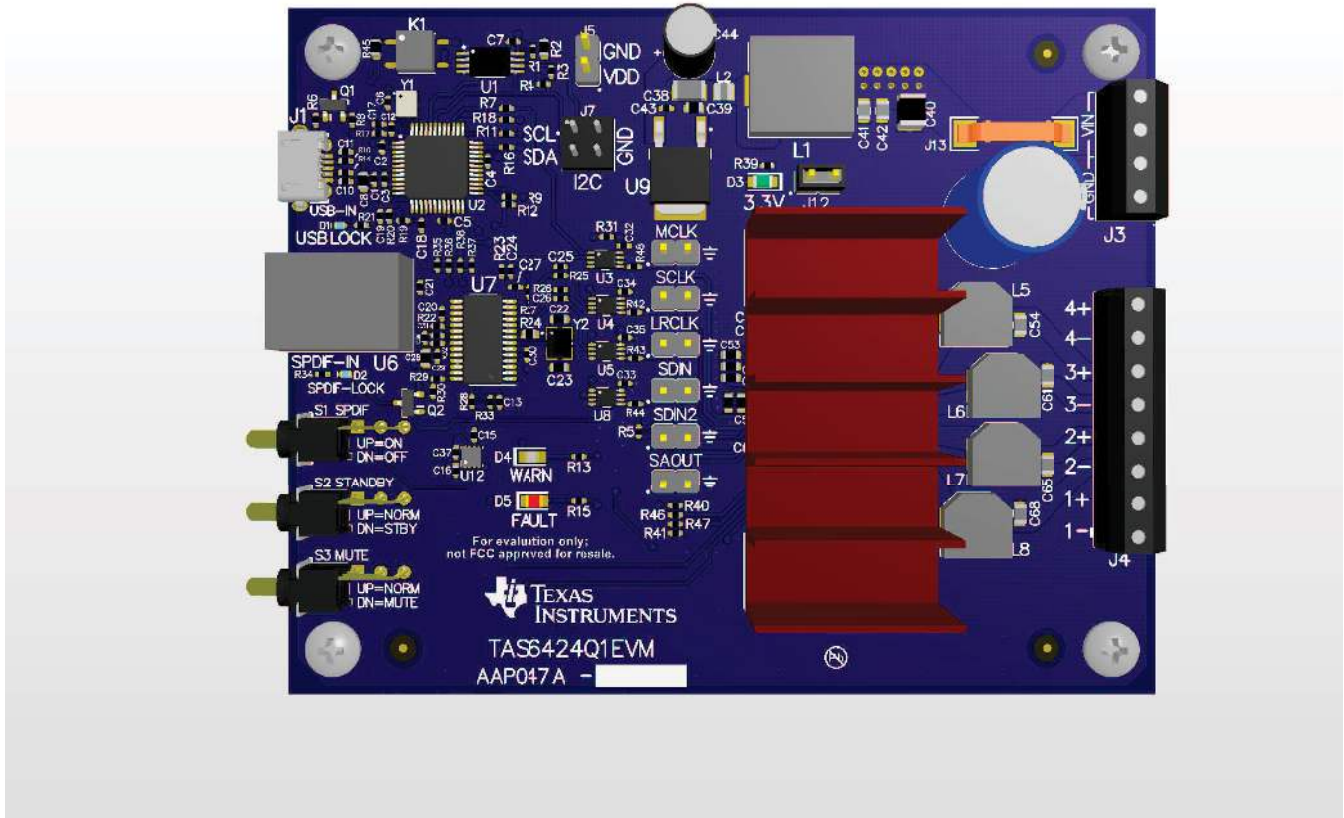

Figure 22. TAS6424 EVM Top

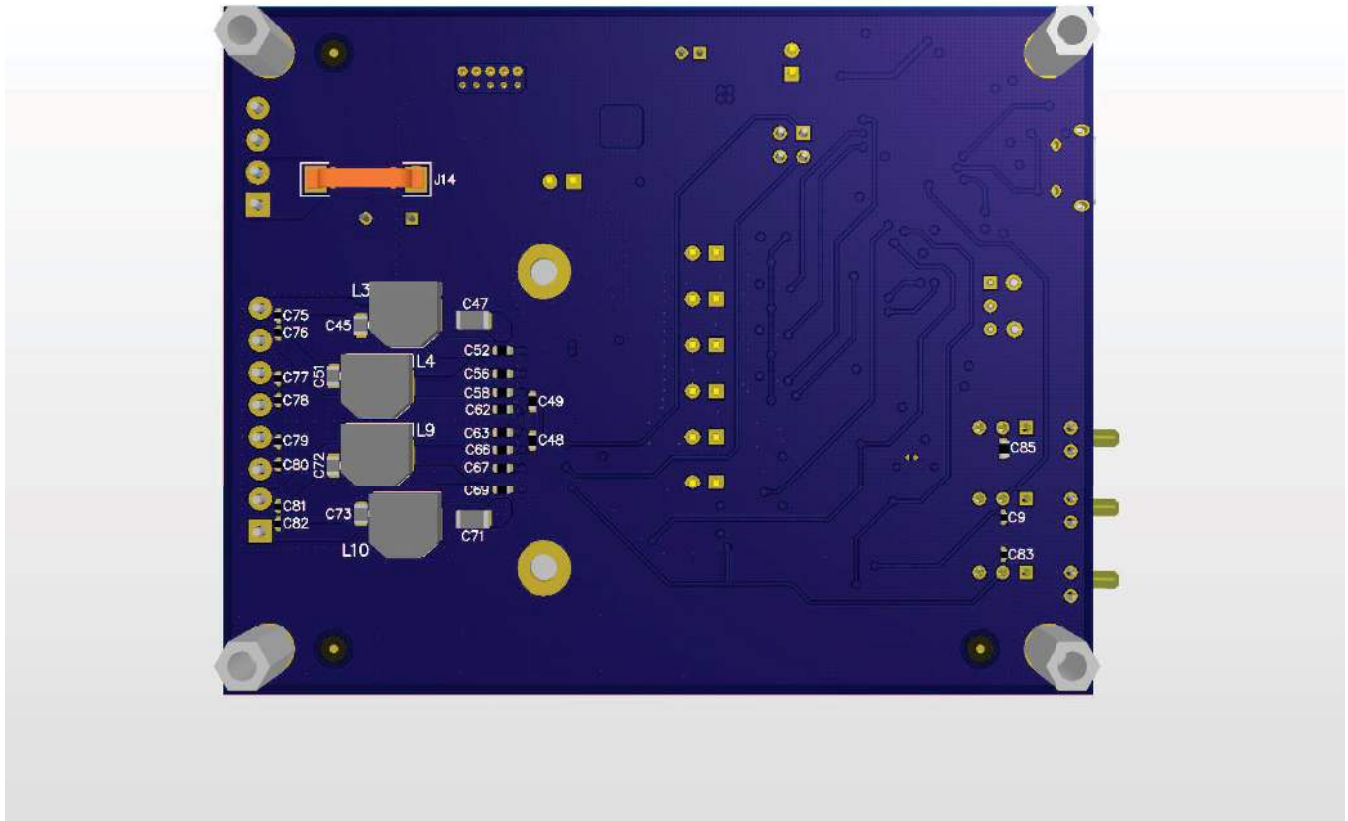

Figure 23. TAS6424 EVM Bottom

4.2 TAS6424E3 EVM Schematic

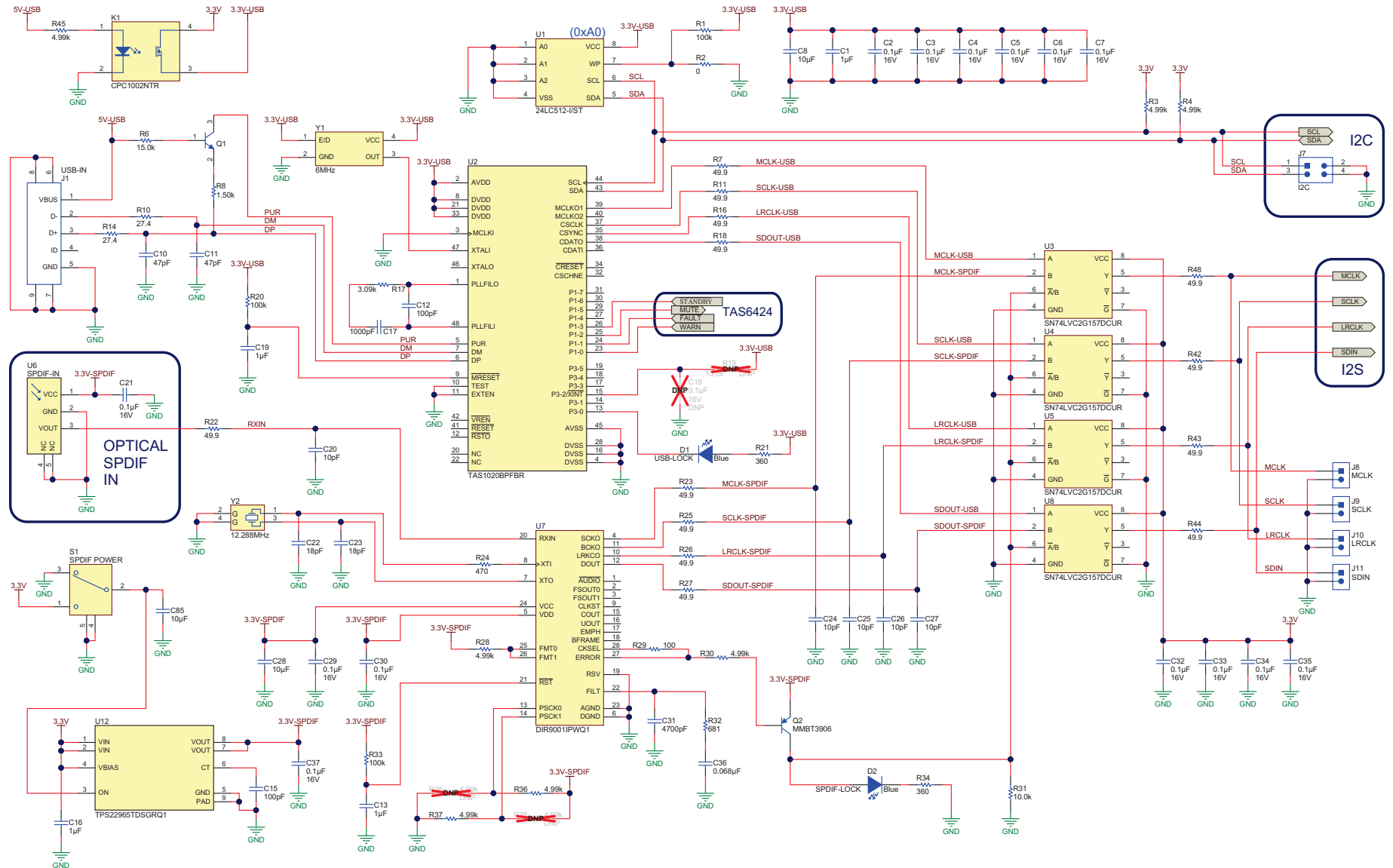

Figure 24. Schematic (Page 1)

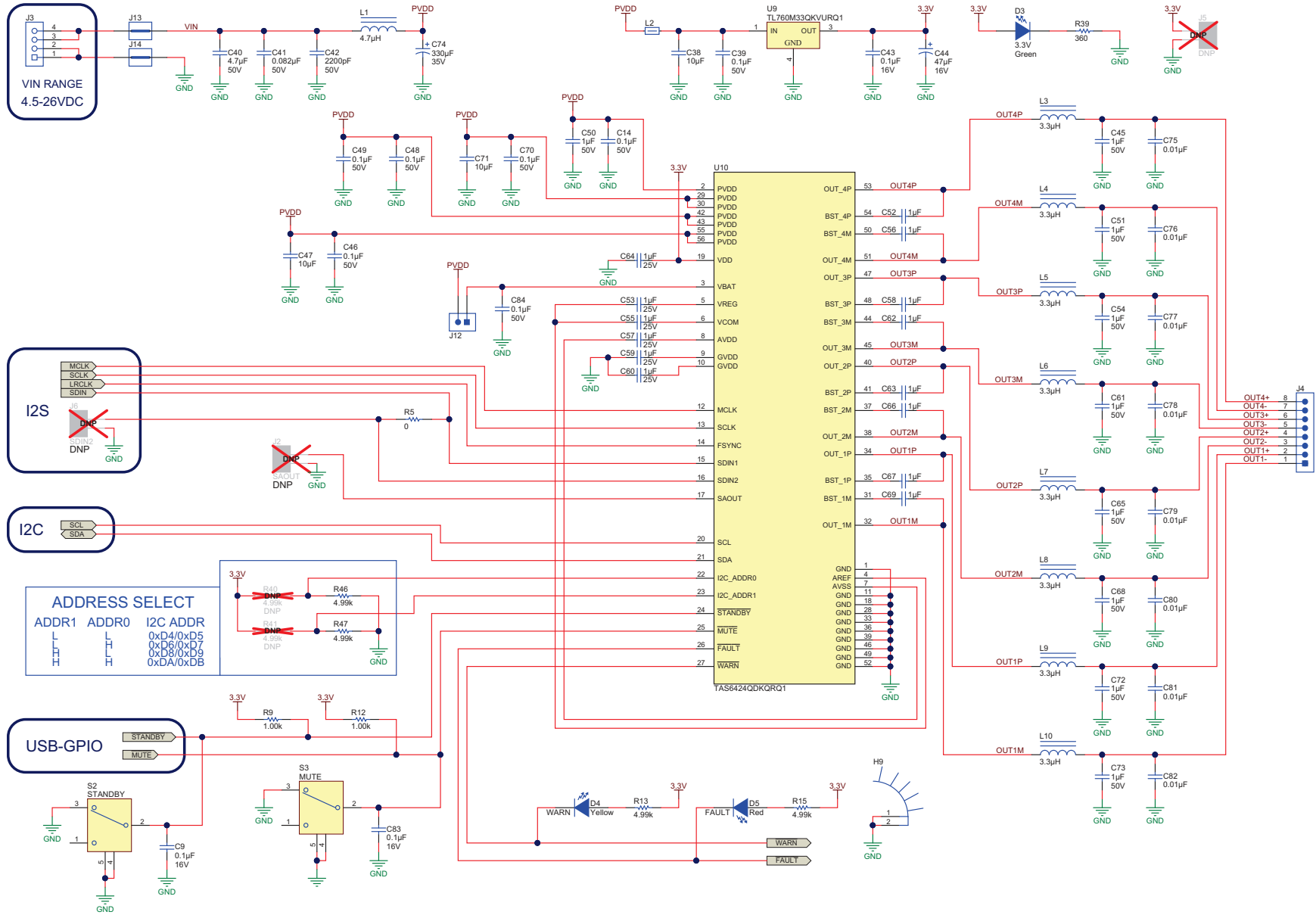

Figure 25. Schematic (Page 2)

4.3 Bill of Materials

Table 1 lists the TAS6424Q1EVM bill of materials.

Table 1. TAS6424Q1EVM Bill of Materials

Designator	Quantity	Value	Description	Package Reference	Part Number	Manufacturer	Alternate Part Number	Alternate Manufacturer
PCB1	1		Printed Circuit Board		AAP047	Any		
C1, C13, C16, C19	4	1uF	CAP, CERM, 1 μ F, 6.3 V, +/- 20%, X5R, 0402	0402	C1005X5R0J105M050BB	TDK		
C2, C3, C4, C5, C6, C7, C9, C21, C29, C30, C32, C33, C34, C35, C37, C43, C83	17	0.1uF	CAP, CERM, 0.1uF, 16V, +/-10%, X7R, 0402	0402	GRM155R71C104KA88D	Murata		
C8, C28, C85	3	10uF	CAP, CERM, 10 μ F, 10 V, +/- 20%, X5R, 0603	0603	C1608X5R1A106M080AC	TDK		
C10, C11	2	47pF	CAP, CERM, 47pF, 25V, +/-5%, C0G/NP0, 0402	0402	GRM1555C1E470JA01D	Murata		
C12, C15	2	100pF	CAP, CERM, 100pF, 50V, +/-5%, C0G/NP0, 0402	0402	GRM1555C1H101JA01D	Murata		
C14, C39, C46, C48, C49, C70, C84	7	0.1uF	CAP, CERM, 0.1 μ F, 50 V, +/- 10%, X7R, 0603	0603	GCM188R71H104KA57D	Murata		
C17	1	1000pF	CAP, CERM, 1000pF, 50V, +/-5%, C0G/NP0, 0402	0402	GRM1555C1H102JA01D	Murata		
C20, C24, C25, C26, C27	5	10pF	CAP, CERM, 10 pF, 50 V, +/- 5%, C0G/NP0, 0402	0402	GRM1555C1H100JA01D	Murata		
C22, C23	2	18pF	CAP, CERM, 18 pF, 50 V, +/- 5%, C0G/NP0, 0603	0603	GRM1885C1H180JA01D	Murata		
C31	1	4700pF	CAP, CERM, 4700 pF, 25 V, +/- 10%, X7R, 0402	0402	GRM155R71E472KA01D	Murata		
C36	1	0.068uF	CAP, CERM, 0.068 μ F, 50 V, +/- 10%, X7R, 0402	0402	C1005X7R1H683K050BB	TDK		
C38, C47, C71	3	10uF	CAP, CERM, 10 μ F, 35 V, +/- 10%, X7R, 1206_190	1206_190	GMK316AB7106KL-TR	Taiyo Yuden		
C40	1	4.7uF	CAP, CERM, 4.7 μ F, 50 V, +/- 10%, X7R, 1210	1210	GRM32ER71H475KA88L	Murata		
C41	1	0.082uF	CAP, CERM, 0.082 μ F, 50 V, +/- 10%, X7R, 0805	0805	08055C823KAT2A	AVX		
C42	1	2200pF	CAP, CERM, 2200 pF, 50 V, +/- 5%, C0G/NP0, 0805	0805	GRM2165C1H222JA01D	Murata		
C44	1	47uF	CAP, AL, 47 μ F, 16 V, +/- 20%, 0.8 ohm, TH	D5xL11mm	EEU-FC1C470	Panasonic		
C45, C51, C54, C61, C65, C68, C72, C73	8	1uF	CAP, CERM, 1 μ F, 50 V, +/- 10%, X7R, 0805	0805	GRM21BR71H105KA12L	Murata		
C50	1	1uF	CAP, CERM, 1 μ F, 50 V, +/- 10%, X7R, 0603	0603	UMK107AB7105KA-T	Taiyo Yuden		
C52, C53, C55, C56, C57, C58, C59, C60, C62, C63, C64, C66, C67, C69	14	1uF	CAP, CERM, 1 μ F, 25 V, +/- 10%, X7R, 0603	0603	GRM188R71E105KA12D	Murata		
C74	1	330uF	CAP, AL, 330 μ F, 35 V, +/- 20%, ohm, TH	D10xL20mm	UBT1V331MPD1TD	Nichicon		
C75, C76, C77, C78, C79, C80, C81, C82	8	0.01uF	CAP, CERM, 0.01 μ F, 50 V, +/- 10%, C0G/NP0, 0402	0402	GCM155R71H103KA55D	Murata		
D1, D2	2	Blue	LED, Blue, SMD	Blue LED	SMLP12BC7TT86	Rohm		
D3	1	Green	LED, Green, SMD	LED_0805	LTST-C170KGKT	Lite-On		

Table 1. TAS6424Q1EVM Bill of Materials (continued)

Designator	Quantity	Value	Description	Package Reference	Part Number	Manufacturer	Alternate Part Number	Alternate Manufacturer
D4	1	Yellow	LED, Yellow, SMD	LED_0805	LTST-C170KSKT	Lite-On		
D5	1	Red	LED, Red, SMD	Red 0805 LED	LTST-C170KRKT	Lite-On		
H1, H2, H3, H4	4		MACHINE SCREW PAN PHILLIPS M3 5mm	Screw M3 Phillips head	MPMS 003 0005 PH	B & F Fastener Supply		
H5, H6, H7, H8	4		Standoff, Hex, 12mm, M3, Aluminum	Aluminum M3 12mm Hex Standoff	24434	Keystone		
H9	1		Heat Sink for DKQ Packages, 41.4x20 mm	Heat Sink for DKQ Packages, 41.4x20 mm	HEATSINK-DKQ56_20MMX41.4X32.77MM	Any		
J1	1		Connector, Receptacle, Micro-USB Type AB, R/A, Bottom Mount SMT	Connector, USB Micro AB	DX4R205JJAR1800	JAE Electronics		
J3	1		Terminal Block, 3.5mm Pitch, 4x1, TH	14x8.2x6.5mm	ED555/4DS	On-Shore Technology		
J4	1		Terminal Block, 3.5mm, 8-Pos, TH	Terminal Block, 3.5mm, 8-Pos, TH	ED555/8DS	On-Shore Technology		
J7	1		Header, 100mil, 2x2, Tin, TH	Header, 2x2, 2.54mm, TH	PEC02DAAN	Sullins Connector Solutions		
J8, J9, J10, J11, J12	5		Header, 100mil, 2x1, Gold, TH	Sullins 100mil, 1x2, 230 mil above insulator	PBC02SAAN	Sullins Connector Solutions		
J13, J14	2		JUMPER TIN SMD, SMT	JUMPER TIN SMD	S1621-46R	Harwin		
K1	1		Relay, SPST-NO (1 Form A), 0.7 A, SMD	4.089x3.81mm	CPC1002NTR	IXYS		
L1	1	4.7uH	Inductor, Shielded, 4.7 uH, 9.7 A, 0.016 ohm, AEC-Q200 Grade 1, SMD	10.8x10mm	DFEG10040D-4R7M=P3	Murata Toko		
L2	1	300 ohm	Ferrite Bead, 300 ohm @ 100 MHz, 3.1 A, 0806	0806	NFZ2MSM301SN10L	Murata		
L3, L4, L5, L6, L7, L8, L9, L10	8	3.3uH	Inductor, Shielded, Metal Composite, 3.3 uH, 6.7 A, 0.024 ohm, AEC-Q200 Grade 1, SMD	7x6.6mm	DFEG7030D-3R3M=P3	Murata Toko		
Q1	1	0.3V	Transistor, NPN, 40V, 0.15A, SOT-23	SOT-23	MMBT2222A	Fairchild Semiconductor		
Q2	1	40 V	Transistor, PNP, 40 V, 0.2 A, SOT-23	SOT-23	MMBT3906	Fairchild Semiconductor		
R1, R20, R33	3	100k	RES, 100k ohm, 1%, 0.063W, 0402	0402	CRCW0402100KFKED	Vishay-Dale		
R2	1	0	RES, 0, 5%, 0.1 W, 0603	0603	CRCW06030000Z0EA	Vishay-Dale		
R3, R4, R13, R15, R28, R30, R36, R37, R46, R47	10	4.99k	RES, 4.99k ohm, 1%, 0.063W, 0402	0402	CRCW04024K99FKED	Vishay-Dale		
R5	1	0	RES, 0, 5%, 0.063 W, 0402	0402	CRCW04020000Z0ED	Vishay-Dale		
R6	1	15.0k	RES, 15.0k ohm, 1%, 0.063W, 0402	0402	CRCW040215K0FKED	Vishay-Dale		
R7, R11, R16, R18, R22, R23, R25, R26, R27	9	49.9	RES, 49.9 ohm, 1%, 0.063W, 0402	0402	CRCW040249R9FKED	Vishay-Dale		
R8	1	1.50k	RES, 1.50k ohm, 1%, 0.063W, 0402	0402	CRCW04021K50FKED	Vishay-Dale		
R9, R12	2	1.00k	RES, 1.00 k, 1%, 0.063 W, 0402	0402	CRCW04021K00FKED	Vishay-Dale		
R10, R14	2	27.4	RES, 27.4 ohm, 1%, 0.063W, 0402	0402	CRCW040227R4FKED	Vishay-Dale		
R17	1	3.09k	RES, 3.09k ohm, 1%, 0.063W, 0402	0402	CRCW04023K09FKED	Vishay-Dale		
R21, R34, R39	3	360	RES, 360 ohm, 5%, 0.063W, 0402	0402	CRCW0402360RJNED	Vishay-Dale		
R24	1	470	RES, 470, 1%, 0.1 W, 0603	0603	RC0603FR-07470RL	Yageo America		

Table 1. TAS6424Q1EVM Bill of Materials (continued)

Designator	Quantity	Value	Description	Package Reference	Part Number	Manufacturer	Alternate Part Number	Alternate Manufacturer
R29	1	100	RES, 100, 1%, 0.1 W, 0402	0402	ERJ-2RKF1000X	Panasonic		
R31	1	10.0k	RES, 10.0 k, 1%, 0.063 W, 0402	0402	CRCW040210K0FKED	Vishay-Dale		
R32	1	681	RES, 681, 1%, 0.063 W, 0402	0402	CRCW0402681RFKED	Vishay-Dale		
R42, R43, R44, R48	4	49.9	RES, 49.9, 1%, 0.063 W, 0402	0402	CRCW040249R9FKED	Vishay-Dale		
R45	1	4.99k	RES, 4.99 k, 1%, 0.1 W, 0603	0603	CRCW06034K99FKEA	Vishay-Dale		
S1, S2, S3	3		Switch, SPDT, On-On, 1 Pos, 0.4A, 28 VDC, TH	5.6x5.4mm	FT1D-4M-Z	Copal Electronics		
SH1	1		Shunt, 2.54mm, Gold, Black	Shunt, 2.54mm, Black	60900213421	Würth Elektronik		
U1	1		EEPROM, 512KBIT, 400KHZ, 8TSSOP	TSSOP-8	24LC512-I/ST	Microchip		
U2	1		USB Streaming Controller, PFB0048A, NRND	PFB0048A	TAS1020BPFBR	Texas Instruments	TAS1020BPFB	Texas Instruments
U3, U4, U5, U8	4		Single 2-Line to 1-Line Data Selector Multiplexer, DCU0008A	DCU0008A	SN74LVC2G157DCUR	Texas Instruments	SN74LVC2G157DCUT	Texas Instruments
U6	1		Photolink- Fiber Optic Receiver, TH	13.5x10x9.7mm	PLR135/T10	Everlight		
U7	1		Automotive Catalog 96-kHz 24-Bit Digital Audio Interface Receiver, 50 ps Jitter, 3.3V, -40 to 85 degC, 28-Pin TSSOP (PW), Green (RoHS & no Sb/Br)	PW0028A	DIR9001IPWQ1	Texas Instruments	Equivalent	None
U9	1		Single Output Automotive LDO, 500 mA, Fixed 3.3 V Output, 3.8 to 26 V Input, 3-pin PFM (KVU), -40 to 125 degC, Green (RoHS & no Sb/Br)	KVU0003A	TL760M33QKVURQ1	Texas Instruments	Equivalent	None
U10	1		Four-Channel Digital Input Automotive Digital Amplifier, DKQ0056A	DKQ0056A	TAS6424QDKQRQ1	Texas Instruments		Texas Instruments
U12	1		5.5-V, 4-A, 16-mOhm On-Resistance Load Switch, DSG0008A	DSG0008A	TPS22965TDSGRQ1	Texas Instruments	TPS22965TDSGTQ1	Texas Instruments
Y1	1		Oscillator, 6MHz, 3.3V, SMD	2.5x1x2.5mm	625L3I006M00000	CTS Electrocomponents		
Y2	1		Crystal, 12.288MHz, 18pF, SMD	Crystal, 2.5x1x3.2mm	ABM8G-12.288MHZ-18-D2Y-T	Abracon Corporation		
C18	0	0.1uF	CAP, CERM, 0.1uF, 16V, +/-10%, X7R, 0402	0402	GRM155R71C104KA88D	Murata		
FID1, FID2, FID3, FID4, FID5, FID6	0		Fiducial mark. There is nothing to buy or mount.	Fiducial	N/A	N/A		
J2, J5, J6	0		Header, 100mil, 2x1, Gold, TH	Sullins 100mil, 1x2, 230 mil above insulator	PBC02SAAN	Sullins Connector Solutions		
R19	0	10.0k	RES, 10.0 k, 1%, 0.063 W, 0402	0402	CRCW040210K0FKED	Vishay-Dale		
R35, R38, R40, R41	0	4.99k	RES, 4.99k ohm, 1%, 0.063W, 0402	0402	CRCW04024K99FKED	Vishay-Dale		

Revision History

NOTE: Page numbers for previous revisions may differ from page numbers in the current version.

Changes from Original (September 2016) to A Revision	Page
• Changed list item 3 From: "...if J2 is removed and 12 V is provided. If J2 is in,..." To: "...if J12 is removed and 12 V is provided. If J12 is in,..."	1

STANDARD TERMS FOR EVALUATION MODULES

1. *Delivery:* TI delivers TI evaluation boards, kits, or modules, including any accompanying demonstration software, components, and/or documentation which may be provided together or separately (collectively, an "EVM" or "EVMs") to the User ("User") in accordance with the terms set forth herein. User's acceptance of the EVM is expressly subject to the following terms.
 - 1.1 EVMs are intended solely for product or software developers for use in a research and development setting to facilitate feasibility evaluation, experimentation, or scientific analysis of TI semiconductor products. EVMs have no direct function and are not finished products. EVMs shall not be directly or indirectly assembled as a part or subassembly in any finished product. For clarification, any software or software tools provided with the EVM ("Software") shall not be subject to the terms and conditions set forth herein but rather shall be subject to the applicable terms that accompany such Software
 - 1.2 EVMs are not intended for consumer or household use. EVMs may not be sold, sublicensed, leased, rented, loaned, assigned, or otherwise distributed for commercial purposes by Users, in whole or in part, or used in any finished product or production system.
- 2 *Limited Warranty and Related Remedies/Disclaimers:*
 - 2.1 These terms do not apply to Software. The warranty, if any, for Software is covered in the applicable Software License Agreement.
 - 2.2 TI warrants that the TI EVM will conform to TI's published specifications for ninety (90) days after the date TI delivers such EVM to User. Notwithstanding the foregoing, TI shall not be liable for a nonconforming EVM if (a) the nonconformity was caused by neglect, misuse or mistreatment by an entity other than TI, including improper installation or testing, or for any EVMs that have been altered or modified in any way by an entity other than TI, (b) the nonconformity resulted from User's design, specifications or instructions for such EVMs or improper system design, or (c) User has not paid on time. Testing and other quality control techniques are used to the extent TI deems necessary. TI does not test all parameters of each EVM. User's claims against TI under this Section 2 are void if User fails to notify TI of any apparent defects in the EVMs within ten (10) business days after delivery, or of any hidden defects with ten (10) business days after the defect has been detected.
 - 2.3 TI's sole liability shall be at its option to repair or replace EVMs that fail to conform to the warranty set forth above, or credit User's account for such EVM. TI's liability under this warranty shall be limited to EVMs that are returned during the warranty period to the address designated by TI and that are determined by TI not to conform to such warranty. If TI elects to repair or replace such EVM, TI shall have a reasonable time to repair such EVM or provide replacements. Repaired EVMs shall be warranted for the remainder of the original warranty period. Replaced EVMs shall be warranted for a new full ninety (90) day warranty period.
- 3 *Regulatory Notices:*
 - 3.1 *United States*
 - 3.1.1 *Notice applicable to EVMs not FCC-Approved:*

FCC NOTICE: This kit is designed to allow product developers to evaluate electronic components, circuitry, or software associated with the kit to determine whether to incorporate such items in a finished product and software developers to write software applications for use with the end product. This kit is not a finished product and when assembled may not be resold or otherwise marketed unless all required FCC equipment authorizations are first obtained. Operation is subject to the condition that this product not cause harmful interference to licensed radio stations and that this product accept harmful interference. Unless the assembled kit is designed to operate under part 15, part 18 or part 95 of this chapter, the operator of the kit must operate under the authority of an FCC license holder or must secure an experimental authorization under part 5 of this chapter.
 - 3.1.2 *For EVMs annotated as FCC – FEDERAL COMMUNICATIONS COMMISSION Part 15 Compliant:*

CAUTION

This device complies with part 15 of the FCC Rules. Operation is subject to the following two conditions: (1) This device may not cause harmful interference, and (2) this device must accept any interference received, including interference that may cause undesired operation.

Changes or modifications not expressly approved by the party responsible for compliance could void the user's authority to operate the equipment.

FCC Interference Statement for Class A EVM devices

NOTE: This equipment has been tested and found to comply with the limits for a Class A digital device, pursuant to part 15 of the FCC Rules. These limits are designed to provide reasonable protection against harmful interference when the equipment is operated in a commercial environment. This equipment generates, uses, and can radiate radio frequency energy and, if not installed and used in accordance with the instruction manual, may cause harmful interference to radio communications. Operation of this equipment in a residential area is likely to cause harmful interference in which case the user will be required to correct the interference at his own expense.

FCC Interference Statement for Class B EVM devices

NOTE: This equipment has been tested and found to comply with the limits for a Class B digital device, pursuant to part 15 of the FCC Rules. These limits are designed to provide reasonable protection against harmful interference in a residential installation. This equipment generates, uses and can radiate radio frequency energy and, if not installed and used in accordance with the instructions, may cause harmful interference to radio communications. However, there is no guarantee that interference will not occur in a particular installation. If this equipment does cause harmful interference to radio or television reception, which can be determined by turning the equipment off and on, the user is encouraged to try to correct the interference by one or more of the following measures:

- Reorient or relocate the receiving antenna.
- Increase the separation between the equipment and receiver.
- Connect the equipment into an outlet on a circuit different from that to which the receiver is connected.
- Consult the dealer or an experienced radio/TV technician for help.

3.2 Canada

3.2.1 For EVMs issued with an Industry Canada Certificate of Conformance to RSS-210 or RSS-247

Concerning EVMs Including Radio Transmitters:

This device complies with Industry Canada license-exempt RSSs. Operation is subject to the following two conditions:

(1) this device may not cause interference, and (2) this device must accept any interference, including interference that may cause undesired operation of the device.

Concernant les EVMs avec appareils radio:

Le présent appareil est conforme aux CNR d'Industrie Canada applicables aux appareils radio exempts de licence. L'exploitation est autorisée aux deux conditions suivantes: (1) l'appareil ne doit pas produire de brouillage, et (2) l'utilisateur de l'appareil doit accepter tout brouillage radioélectrique subi, même si le brouillage est susceptible d'en compromettre le fonctionnement.

Concerning EVMs Including Detachable Antennas:

Under Industry Canada regulations, this radio transmitter may only operate using an antenna of a type and maximum (or lesser) gain approved for the transmitter by Industry Canada. To reduce potential radio interference to other users, the antenna type and its gain should be so chosen that the equivalent isotropically radiated power (e.i.r.p.) is not more than that necessary for successful communication. This radio transmitter has been approved by Industry Canada to operate with the antenna types listed in the user guide with the maximum permissible gain and required antenna impedance for each antenna type indicated. Antenna types not included in this list, having a gain greater than the maximum gain indicated for that type, are strictly prohibited for use with this device.

Concernant les EVMs avec antennes détachables

Conformément à la réglementation d'Industrie Canada, le présent émetteur radio peut fonctionner avec une antenne d'un type et d'un gain maximal (ou inférieur) approuvé pour l'émetteur par Industrie Canada. Dans le but de réduire les risques de brouillage radioélectrique à l'intention des autres utilisateurs, il faut choisir le type d'antenne et son gain de sorte que la puissance isotrope rayonnée équivalente (p.i.r.e.) ne dépasse pas l'intensité nécessaire à l'établissement d'une communication satisfaisante. Le présent émetteur radio a été approuvé par Industrie Canada pour fonctionner avec les types d'antenne énumérés dans le manuel d'usage et ayant un gain admissible maximal et l'impédance requise pour chaque type d'antenne. Les types d'antenne non inclus dans cette liste, ou dont le gain est supérieur au gain maximal indiqué, sont strictement interdits pour l'exploitation de l'émetteur.

3.3 Japan

3.3.1 *Notice for EVMs delivered in Japan:* Please see http://www.tij.co.jp/lstds/ti_ja/general/eStore/notice_01.page 日本国内に輸入される評価用キット、ボードについては、次のところをご覧ください。
http://www.tij.co.jp/lstds/ti_ja/general/eStore/notice_01.page

3.3.2 *Notice for Users of EVMs Considered "Radio Frequency Products" in Japan:* EVMs entering Japan may not be certified by TI as conforming to Technical Regulations of Radio Law of Japan.

If User uses EVMs in Japan, not certified to Technical Regulations of Radio Law of Japan, User is required to follow the instructions set forth by Radio Law of Japan, which includes, but is not limited to, the instructions below with respect to EVMs (which for the avoidance of doubt are stated strictly for convenience and should be verified by User):

1. Use EVMs in a shielded room or any other test facility as defined in the notification #173 issued by Ministry of Internal Affairs and Communications on March 28, 2006, based on Sub-section 1.1 of Article 6 of the Ministry's Rule for Enforcement of Radio Law of Japan,
2. Use EVMs only after User obtains the license of Test Radio Station as provided in Radio Law of Japan with respect to EVMs, or
3. Use of EVMs only after User obtains the Technical Regulations Conformity Certification as provided in Radio Law of Japan with respect to EVMs. Also, do not transfer EVMs, unless User gives the same notice above to the transferee. Please note that if User does not follow the instructions above, User will be subject to penalties of Radio Law of Japan.

【無線電波を送信する製品の開発キットをお使いになる際の注意事項】 開発キットの中には技術基準適合証明を受けていないものがあります。技術適合証明を受けていないものご使用に際しては、電波法遵守のため、以下のいずれかの措置を取っていただく必要がありますのでご注意ください。

1. 電波法施行規則第6条第1項第1号に基づく平成18年3月28日総務省告示第173号で定められた電波暗室等の試験設備でご使用いただく。
2. 実験局の免許を取得後ご使用いただく。
3. 技術基準適合証明を取得後ご使用いただく。

なお、本製品は、上記の「ご使用にあたっての注意」を譲渡先、移転先に通知しない限り、譲渡、移転できないものとします。

上記を遵守頂けない場合は、電波法の罰則が適用される可能性があることをご留意ください。日本テキサス・インスツルメンツ株式会社
東京都新宿区西新宿 6 丁目 2 4 番 1 号
西新宿三井ビル

3.3.3 *Notice for EVMs for Power Line Communication:* Please see http://www.tij.co.jp/llds/ti_ja/general/eStore/notice_02.page
電力線搬送波通信についての開発キットをお使いになる際の注意事項については、次のところをご覧ください。 http://www.tij.co.jp/llds/ti_ja/general/eStore/notice_02.page

3.4 *European Union*

3.4.1 *For EVMs subject to EU Directive 2014/30/EU (Electromagnetic Compatibility Directive):*

This is a class A product intended for use in environments other than domestic environments that are connected to a low-voltage power-supply network that supplies buildings used for domestic purposes. In a domestic environment this product may cause radio interference in which case the user may be required to take adequate measures.

4 *EVM Use Restrictions and Warnings:*

4.1 EVMS ARE NOT FOR USE IN FUNCTIONAL SAFETY AND/OR SAFETY CRITICAL EVALUATIONS, INCLUDING BUT NOT LIMITED TO EVALUATIONS OF LIFE SUPPORT APPLICATIONS.

4.2 User must read and apply the user guide and other available documentation provided by TI regarding the EVM prior to handling or using the EVM, including without limitation any warning or restriction notices. The notices contain important safety information related to, for example, temperatures and voltages.

4.3 *Safety-Related Warnings and Restrictions:*

4.3.1 User shall operate the EVM within TI's recommended specifications and environmental considerations stated in the user guide, other available documentation provided by TI, and any other applicable requirements and employ reasonable and customary safeguards. Exceeding the specified performance ratings and specifications (including but not limited to input and output voltage, current, power, and environmental ranges) for the EVM may cause personal injury or death, or property damage. If there are questions concerning performance ratings and specifications, User should contact a TI field representative prior to connecting interface electronics including input power and intended loads. Any loads applied outside of the specified output range may also result in unintended and/or inaccurate operation and/or possible permanent damage to the EVM and/or interface electronics. Please consult the EVM user guide prior to connecting any load to the EVM output. If there is uncertainty as to the load specification, please contact a TI field representative. During normal operation, even with the inputs and outputs kept within the specified allowable ranges, some circuit components may have elevated case temperatures. These components include but are not limited to linear regulators, switching transistors, pass transistors, current sense resistors, and heat sinks, which can be identified using the information in the associated documentation. When working with the EVM, please be aware that the EVM may become very warm.

4.3.2 EVMs are intended solely for use by technically qualified, professional electronics experts who are familiar with the dangers and application risks associated with handling electrical mechanical components, systems, and subsystems. User assumes all responsibility and liability for proper and safe handling and use of the EVM by User or its employees, affiliates, contractors or designees. User assumes all responsibility and liability to ensure that any interfaces (electronic and/or mechanical) between the EVM and any human body are designed with suitable isolation and means to safely limit accessible leakage currents to minimize the risk of electrical shock hazard. User assumes all responsibility and liability for any improper or unsafe handling or use of the EVM by User or its employees, affiliates, contractors or designees.

4.4 User assumes all responsibility and liability to determine whether the EVM is subject to any applicable international, federal, state, or local laws and regulations related to User's handling and use of the EVM and, if applicable, User assumes all responsibility and liability for compliance in all respects with such laws and regulations. User assumes all responsibility and liability for proper disposal and recycling of the EVM consistent with all applicable international, federal, state, and local requirements.

5. *Accuracy of Information:* To the extent TI provides information on the availability and function of EVMs, TI attempts to be as accurate as possible. However, TI does not warrant the accuracy of EVM descriptions, EVM availability or other information on its websites as accurate, complete, reliable, current, or error-free.

6. *Disclaimers:*
- 6.1 EXCEPT AS SET FORTH ABOVE, EVMS AND ANY MATERIALS PROVIDED WITH THE EVM (INCLUDING, BUT NOT LIMITED TO, REFERENCE DESIGNS AND THE DESIGN OF THE EVM ITSELF) ARE PROVIDED "AS IS" AND "WITH ALL FAULTS." TI DISCLAIMS ALL OTHER WARRANTIES, EXPRESS OR IMPLIED, REGARDING SUCH ITEMS, INCLUDING BUT NOT LIMITED TO ANY EPIDEMIC FAILURE WARRANTY OR IMPLIED WARRANTIES OF MERCHANTABILITY OR FITNESS FOR A PARTICULAR PURPOSE OR NON-INFRINGEMENT OF ANY THIRD PARTY PATENTS, COPYRIGHTS, TRADE SECRETS OR OTHER INTELLECTUAL PROPERTY RIGHTS.
- 6.2 EXCEPT FOR THE LIMITED RIGHT TO USE THE EVM SET FORTH HEREIN, NOTHING IN THESE TERMS SHALL BE CONSTRUED AS GRANTING OR CONFERRING ANY RIGHTS BY LICENSE, PATENT, OR ANY OTHER INDUSTRIAL OR INTELLECTUAL PROPERTY RIGHT OF TI, ITS SUPPLIERS/LICENSORS OR ANY OTHER THIRD PARTY, TO USE THE EVM IN ANY FINISHED END-USER OR READY-TO-USE FINAL PRODUCT, OR FOR ANY INVENTION, DISCOVERY OR IMPROVEMENT, REGARDLESS OF WHEN MADE, CONCEIVED OR ACQUIRED.
7. *USER'S INDEMNITY OBLIGATIONS AND REPRESENTATIONS.* USER WILL DEFEND, INDEMNIFY AND HOLD TI, ITS LICENSORS AND THEIR REPRESENTATIVES HARMLESS FROM AND AGAINST ANY AND ALL CLAIMS, DAMAGES, LOSSES, EXPENSES, COSTS AND LIABILITIES (COLLECTIVELY, "CLAIMS") ARISING OUT OF OR IN CONNECTION WITH ANY HANDLING OR USE OF THE EVM THAT IS NOT IN ACCORDANCE WITH THESE TERMS. THIS OBLIGATION SHALL APPLY WHETHER CLAIMS ARISE UNDER STATUTE, REGULATION, OR THE LAW OF TORT, CONTRACT OR ANY OTHER LEGAL THEORY, AND EVEN IF THE EVM FAILS TO PERFORM AS DESCRIBED OR EXPECTED.
8. *Limitations on Damages and Liability:*
- 8.1 *General Limitations.* IN NO EVENT SHALL TI BE LIABLE FOR ANY SPECIAL, COLLATERAL, INDIRECT, PUNITIVE, INCIDENTAL, CONSEQUENTIAL, OR EXEMPLARY DAMAGES IN CONNECTION WITH OR ARISING OUT OF THESE TERMS OR THE USE OF THE EVMS , REGARDLESS OF WHETHER TI HAS BEEN ADVISED OF THE POSSIBILITY OF SUCH DAMAGES. EXCLUDED DAMAGES INCLUDE, BUT ARE NOT LIMITED TO, COST OF REMOVAL OR REINSTALLATION, ANCILLARY COSTS TO THE PROCUREMENT OF SUBSTITUTE GOODS OR SERVICES, RETESTING, OUTSIDE COMPUTER TIME, LABOR COSTS, LOSS OF GOODWILL, LOSS OF PROFITS, LOSS OF SAVINGS, LOSS OF USE, LOSS OF DATA, OR BUSINESS INTERRUPTION. NO CLAIM, SUIT OR ACTION SHALL BE BROUGHT AGAINST TI MORE THAN TWELVE (12) MONTHS AFTER THE EVENT THAT GAVE RISE TO THE CAUSE OF ACTION HAS OCCURRED.
- 8.2 *Specific Limitations.* IN NO EVENT SHALL TI'S AGGREGATE LIABILITY FROM ANY USE OF AN EVM PROVIDED HEREUNDER, INCLUDING FROM ANY WARRANTY, INDEMNITY OR OTHER OBLIGATION ARISING OUT OF OR IN CONNECTION WITH THESE TERMS, , EXCEED THE TOTAL AMOUNT PAID TO TI BY USER FOR THE PARTICULAR EVM(S) AT ISSUE DURING THE PRIOR TWELVE (12) MONTHS WITH RESPECT TO WHICH LOSSES OR DAMAGES ARE CLAIMED. THE EXISTENCE OF MORE THAN ONE CLAIM SHALL NOT ENLARGE OR EXTEND THIS LIMIT.
9. *Return Policy.* Except as otherwise provided, TI does not offer any refunds, returns, or exchanges. Furthermore, no return of EVM(s) will be accepted if the package has been opened and no return of the EVM(s) will be accepted if they are damaged or otherwise not in a resalable condition. If User feels it has been incorrectly charged for the EVM(s) it ordered or that delivery violates the applicable order, User should contact TI. All refunds will be made in full within thirty (30) working days from the return of the components(s), excluding any postage or packaging costs.
10. *Governing Law:* These terms and conditions shall be governed by and interpreted in accordance with the laws of the State of Texas, without reference to conflict-of-laws principles. User agrees that non-exclusive jurisdiction for any dispute arising out of or relating to these terms and conditions lies within courts located in the State of Texas and consents to venue in Dallas County, Texas. Notwithstanding the foregoing, any judgment may be enforced in any United States or foreign court, and TI may seek injunctive relief in any United States or foreign court.

IMPORTANT NOTICE FOR TI DESIGN INFORMATION AND RESOURCES

Texas Instruments Incorporated ("TI") technical, application or other design advice, services or information, including, but not limited to, reference designs and materials relating to evaluation modules, (collectively, "TI Resources") are intended to assist designers who are developing applications that incorporate TI products; by downloading, accessing or using any particular TI Resource in any way, you (individually or, if you are acting on behalf of a company, your company) agree to use it solely for this purpose and subject to the terms of this Notice.

TI's provision of TI Resources does not expand or otherwise alter TI's applicable published warranties or warranty disclaimers for TI products, and no additional obligations or liabilities arise from TI providing such TI Resources. TI reserves the right to make corrections, enhancements, improvements and other changes to its TI Resources.

You understand and agree that you remain responsible for using your independent analysis, evaluation and judgment in designing your applications and that you have full and exclusive responsibility to assure the safety of your applications and compliance of your applications (and of all TI products used in or for your applications) with all applicable regulations, laws and other applicable requirements. You represent that, with respect to your applications, you have all the necessary expertise to create and implement safeguards that (1) anticipate dangerous consequences of failures, (2) monitor failures and their consequences, and (3) lessen the likelihood of failures that might cause harm and take appropriate actions. You agree that prior to using or distributing any applications that include TI products, you will thoroughly test such applications and the functionality of such TI products as used in such applications. TI has not conducted any testing other than that specifically described in the published documentation for a particular TI Resource.

You are authorized to use, copy and modify any individual TI Resource only in connection with the development of applications that include the TI product(s) identified in such TI Resource. NO OTHER LICENSE, EXPRESS OR IMPLIED, BY ESTOPPEL OR OTHERWISE TO ANY OTHER TI INTELLECTUAL PROPERTY RIGHT, AND NO LICENSE TO ANY TECHNOLOGY OR INTELLECTUAL PROPERTY RIGHT OF TI OR ANY THIRD PARTY IS GRANTED HEREIN, including but not limited to any patent right, copyright, mask work right, or other intellectual property right relating to any combination, machine, or process in which TI products or services are used. Information regarding or referencing third-party products or services does not constitute a license to use such products or services, or a warranty or endorsement thereof. Use of TI Resources may require a license from a third party under the patents or other intellectual property of the third party, or a license from TI under the patents or other intellectual property of TI.

TI RESOURCES ARE PROVIDED "AS IS" AND WITH ALL FAULTS. TI DISCLAIMS ALL OTHER WARRANTIES OR REPRESENTATIONS, EXPRESS OR IMPLIED, REGARDING TI RESOURCES OR USE THEREOF, INCLUDING BUT NOT LIMITED TO ACCURACY OR COMPLETENESS, TITLE, ANY EPIDEMIC FAILURE WARRANTY AND ANY IMPLIED WARRANTIES OF MERCHANTABILITY, FITNESS FOR A PARTICULAR PURPOSE, AND NON-INFRINGEMENT OF ANY THIRD PARTY INTELLECTUAL PROPERTY RIGHTS.

TI SHALL NOT BE LIABLE FOR AND SHALL NOT DEFEND OR INDEMNIFY YOU AGAINST ANY CLAIM, INCLUDING BUT NOT LIMITED TO ANY INFRINGEMENT CLAIM THAT RELATES TO OR IS BASED ON ANY COMBINATION OF PRODUCTS EVEN IF DESCRIBED IN TI RESOURCES OR OTHERWISE. IN NO EVENT SHALL TI BE LIABLE FOR ANY ACTUAL, DIRECT, SPECIAL, COLLATERAL, INDIRECT, PUNITIVE, INCIDENTAL, CONSEQUENTIAL OR EXEMPLARY DAMAGES IN CONNECTION WITH OR ARISING OUT OF TI RESOURCES OR USE THEREOF, AND REGARDLESS OF WHETHER TI HAS BEEN ADVISED OF THE POSSIBILITY OF SUCH DAMAGES.

You agree to fully indemnify TI and its representatives against any damages, costs, losses, and/or liabilities arising out of your non-compliance with the terms and provisions of this Notice.

This Notice applies to TI Resources. Additional terms apply to the use and purchase of certain types of materials, TI products and services. These include; without limitation, TI's standard terms for semiconductor products (<http://www.ti.com/sc/docs/stdterms.htm>), [evaluation modules](#), and [samples](http://www.ti.com/sc/docs/sampterm.htm) (<http://www.ti.com/sc/docs/sampterm.htm>).

Mailing Address: Texas Instruments, Post Office Box 655303, Dallas, Texas 75265
Copyright © 2017, Texas Instruments Incorporated