

CLC409

Very Wideband, Low Distortion Monolithic Op Amp

General Description

The CLC409 is a very wideband, DC coupled monolithic operational amplifier designed specifically for wide dynamic range systems requiring exceptional signal fidelity. Benefiting from National's current feedback architecture, the CLC409 offers a gain range of ± 1 to ± 10 while providing stable, oscillation free operation without external compensation, even at unity gain.

With its 350MHz small signal bandwidth ($V_{OUT} = 2V_{PP}$), 10-bit distortion levels through 20MHz ($R_L = 100\Omega$), 8-bit distortion levels through 60MHz, $2.2nV/\sqrt{Hz}$ input referred noise and 13.5mA supply current, the CLC409 is the ideal driver or buffer for high speed flash A/D and D/A converters.

Wide dynamic range systems such as radar and communication receivers requiring a wideband amplifier offering exceptional signal purity will find the CLC409's low input referred noise and low harmonic and intermodulation distortion make it an attractive high speed solution.

Constructed using an advanced, complimentary bipolar process and National's proven current feedback architecture, the CLC409 is available in several versions to meet a variety of requirements.

Enhanced Solutions (Military/Aerospace)

SMD Number: 5962-92034

Space level versions also available.

For more information, visit <http://www.national.com/mil>

Features

- 350MHz small signal bandwidth
- -65/-72dBc 2nd/3rd harmonics (20MHz)
- Low noise
- 8ns settling to 0.1%
- 1200V/ μs slew rate
- 13.5mA supply current ($\pm 5V$)
- 60mA output current

Applications

- Flash A/D driver
- D/A transimpedance buffer
- Wide dynamic range IF amp
- Radar/communication receivers
- DDS post-amps
- Wideband inverting summer
- Line driver

Harmonic Distortion vs. Load and Frequency

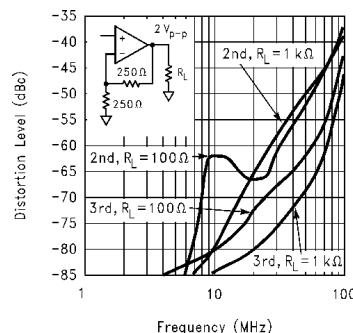

01274804

Connection Diagrams

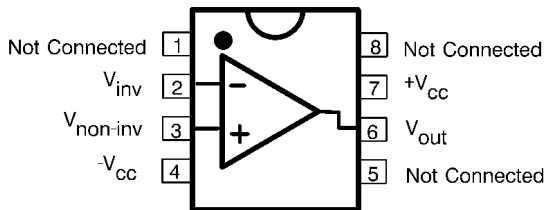

01274815

Pinout
DIP & SOIC

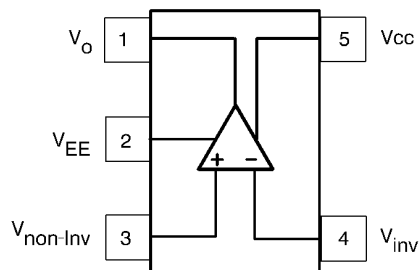

01274814

Pinout
SOT23-5

Absolute Maximum Ratings (Note 1)

If Military/Aerospace specified devices are required, please contact the National Semiconductor Sales Office/Distributors for availability and specifications.

Supply Voltage (V_{CC})	$\pm 7V$
I_{OUT}	
Output is short circuit protected to ground, but maximum reliability will be maintained if I_{OUT} does not exceed...	60mA
Common Mode Input Voltage	$\pm V_{CC}$
Differential Input Voltage	10V
Junction Temperature	+150°C

Operating Temperature Range	-40°C to +85°C
Storage Temperature Range	-65°C to +150°C
Lead Solder Duration (+300°C)	10 sec
ESD rating (human body model)	1000V

Operating Ratings

Thermal Resistance		
Package	(θ_{JC})	(θ_{JA})
MDIP	95°C/W	115°C/W
SOIC	75°C/W	160°C/W
SOT23-5	115°C/W	185°C/W

Electrical Characteristics

$A_V = +2$, $V_{CC} = \pm 5V$, $R_L = 100\Omega$, $R_f = 250\Omega$; unless specified

Symbol	Parameter	Conditions	Typ	Max/Min (Note 2)			Units
Ambient Temperature		CLC409AJ	+25°C	-40°C	+25°C	+85°C	
Frequency Domain Performance							
SSBW	-3dB Bandwidth	$V_{OUT} < 2V_{PP}$	350	>250	>250	>200	MHz
LSBW		$V_{OUT} < 5V_{PP}$	110	>90	>90	>80	MHz
	Gain Flatness	$V_{OUT} < 0.5V_{PP}$					
GFPL	Peaking	DC to 75MHz	0	<0.4	<0.4	<0.4	dB
GFPH	Peaking	>75MHz	0	<0.8	<0.8	<0.8	dB
GFR1	Rolloff	DC to 125MHz	0.2	<1.0	<1.0	<1.0	dB
GFR2	Rolloff	@ 200MHz	1.0	<2.0	<2.2	<3.0	dB
LPD	Linear Phase Deviation	DC to 100MHz	0.3	<0.8	<0.8	<1.0	deg
DG1	Differential Gain	$R_L = 150\Omega$, 3.58MHz	0.03	<0.07	<0.06	<0.06	%
DG2		$R_L = 150\Omega$, 4.43MHz	0.03	<0.07	<0.06	<0.06	%
DP1	Differential Phase	$R_L = 150\Omega$, 3.58MHz	0.01	<0.02	<0.02	<0.02	deg
DP2		$R_L = 150\Omega$, 4.43MHz	0.01	<0.02	<0.02	<0.02	deg
Time Domain Response							
TRS	Rise and Fall Time	2V Step	1.3	<1.6	<1.6	<1.6	ns
TRL		5V Step	3.5	<4.2	<4.2	<4.6	ns
TS	Settling Time to $\pm 0.1\%$	2V Step	8	<12	<12	<12	ns
OS	Overshoot	2V Step	5	<15	<18	<18	%
SR	Slew Rate		1200	>1000	>1000	>1000	V/ μ s
Distortion And Noise Response							
HD2L	2nd Harmonic Distortion	$2V_{PP}$, 5MHz	-86	<-78	<-81	<-81	dBc
HD2		$2V_{PP}$, 20MHz	-65	<-56	<-56	<-56	dBc
HD2H		$2V_{PP}$, 60MHz	-49	<-41	<-44	<-44	dBc
HD3L	3rd Harmonic Distortion	$2V_{PP}$, 5MHz	-84	<-76	<-76	<-76	dBc
HD3		$2V_{PP}$, 20MHz	-72	<-65	<-65	<-65	dBc
HD3H		$2V_{PP}$, 60MHz	-59	<-52	<-52	<-52	dBc
Equivalent Input Noise							
VN	Non-Inverting Voltage	>1MHz	2.2	<2.8	<2.8	<3.1	nV/ \sqrt{Hz}
ICN	Inverting Current	>1MHz	14.3	<18	<18	<20	pA/ \sqrt{Hz}
NCN	Non-Inverting Current	>1MHz	3.2	<4.0	<4.0	<4.5	pA/ \sqrt{Hz}
SNF	Total Noise Floor	>1MHz	-157	<-155	<-155	<-154	dBm _{1Hz}
INV	Total Integrated Noise	1MHz to 150MHz	38	<47	<47	<52	μ V

Electrical Characteristics (Continued)
 $A_V = +2$, $V_{CC} = \pm 5V$, $R_L = 100\Omega$, $R_f = 250\Omega$; unless specified

Symbol	Parameter	Conditions	Typ	Max/Min (Note 2)			Units
Static, DC Performance							
VIO	Input Offset Voltage (Note 3)		0.5	<8.5	<4.5	<9.5	mV
DVIO	Average Temperature Coefficient		25	<50	-	<50	$\mu V/^{\circ}C$
IBN	Input Bias Current (Note 3)	Non Inverting	10	<44	<22	<22	μA
DIBN	Average Temperature Coefficient		100	<275	-	<125	$nA/^{\circ}C$
IBI	Input Bias Current (Note 3)	Inverting	10	<36	<20	<30	μA
DIBI	Average Temperature Coefficient		100	<200	-	<100	$nA/^{\circ}C$
PSRR	Power Supply Rejection Ratio		50	>45	>45	>45	dB
CMRR	Common Mode Rejection Ratio		50	>45	>45	>45	dB
ICC	Supply Current (Note 3)	No Load	13.5	<14.2	<14.2	<14.2	mA
Miscellaneous Performance							
RIN	Non-Inverting Input Resistance		1000	>250	>500	>1000	k Ω
CIN	Non-Inverting Input Capacitance		1	<2	<2	<2	pF
RO	Output Impedance	DC	0.1	<0.3	<0.2	<0.2	Ω
VO	Output Voltage Range	$R_L = 100\Omega$	± 3.5	$> \pm 3.0$	$> \pm 3.2$	$> \pm 3.2$	V
CMIR	Common Mode Input Range		± 2.2	± 1.5	± 2.0	± 2.0	V
IO	Output Current		60	36	50	50	mA

Note 1: "Absolute Maximum Ratings" are those values beyond which the safety of the device cannot be guaranteed. They are not meant to imply that the devices should be operated at these limits. The table of "Electrical Characteristics" specifies conditions of device operation.

Note 2: Max/min ratings are based on product characterization and simulation. Individual parameters are tested as noted. Outgoing quality levels are determined from tested parameters.

Note 3: AJ-level: spec. is 100% tested at +25°C.

Ordering Information

Package	Temperature Range Industrial	Part Number	Package Marking	NSC Drawing
8-pin plastic DIP	-40°C to +85°C	CLC409AJP	CLC409AJP	N08E
8-pin plastic SOIC	-40°C to +85°C	CLC409AJE	CLC409AJE	M08A
5-pin SOT	-40°C to +85°C	CLC409AJM5	A18	MA05A

Typical Performance Characteristics ($T_A = 25^\circ\text{C}$, $A_V = +6$, $V_{CC} = \pm 5\text{V}$, $R_L = 100\Omega$, $R_f = 500\Omega$; Unless Specified).

Non-Inverting Frequency Response

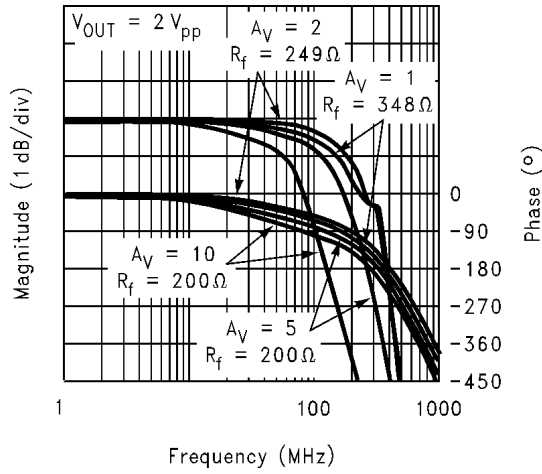

01274801

Inverting Frequency Response

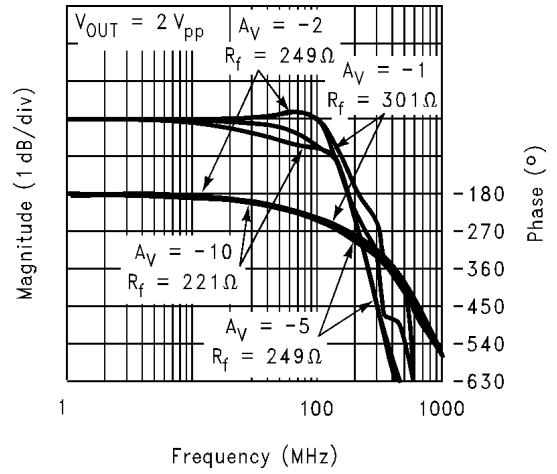

01274802

Frequency Response for Various R_L S

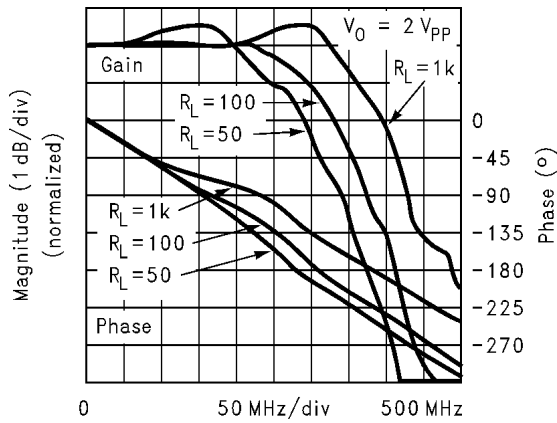

01274803

Small Signal Pulse Response

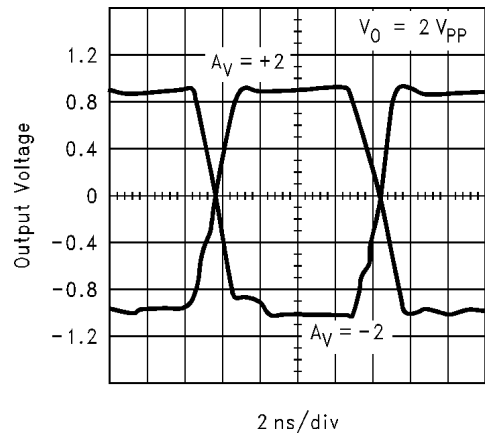

01274816

Short-Term Settling Response

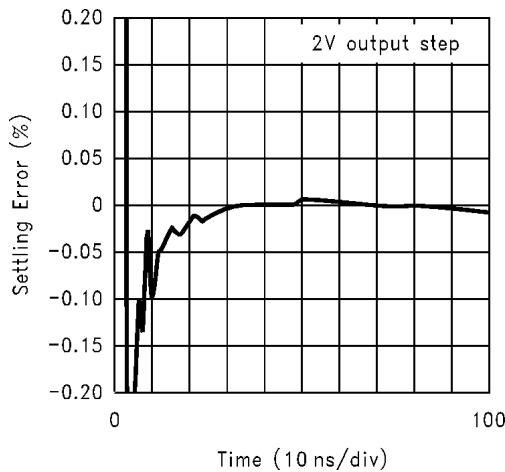

01274817

Long-Term Settling Time

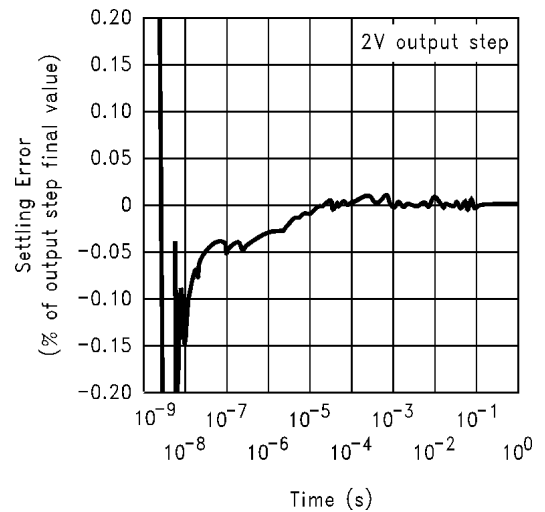

01274818

Typical Performance Characteristics ($T_A = 25^\circ\text{C}$, $A_V = +6$, $V_{CC} = \pm 5\text{V}$, $R_L = 100\Omega$, $R_f = 500\Omega$; Unless Specified). (Continued)

Harmonic Distortion vs. Load and Frequency

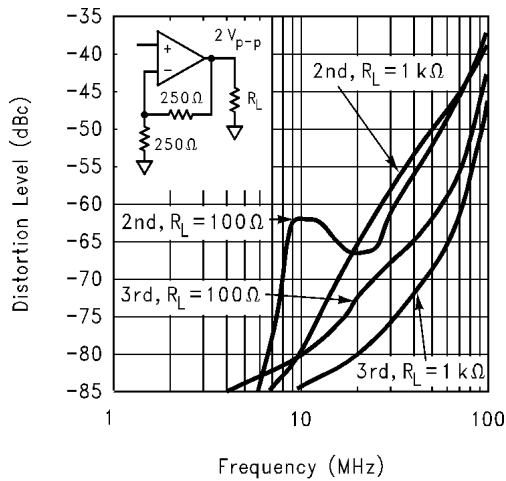

01274804

2-Tone, 3rd Order Spurious Levels

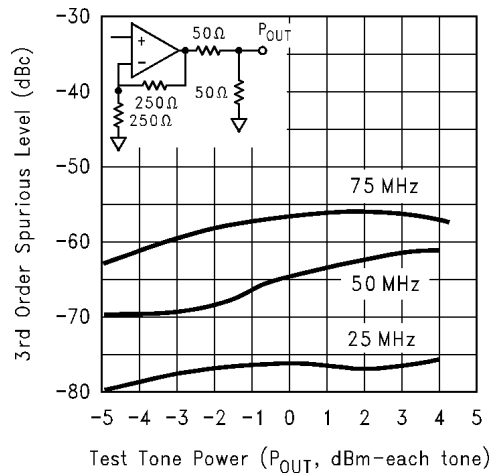

01274805

Settling Time vs. Capacitive Load

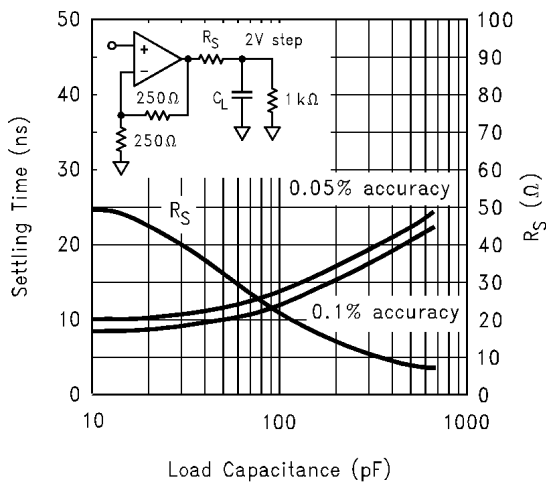

01274806

2nd Harmonic Distortion vs. P_{OUT}

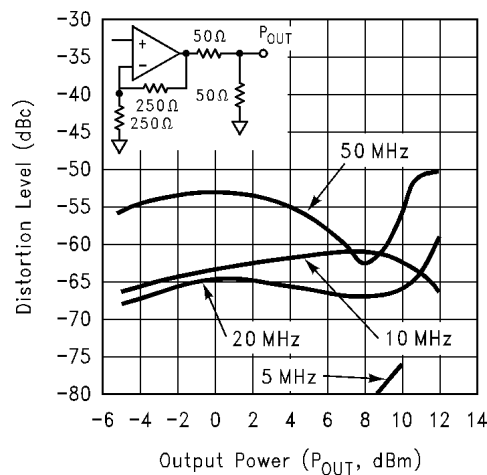

01274807

3rd Harmonic Distortion vs. P_{OUT}

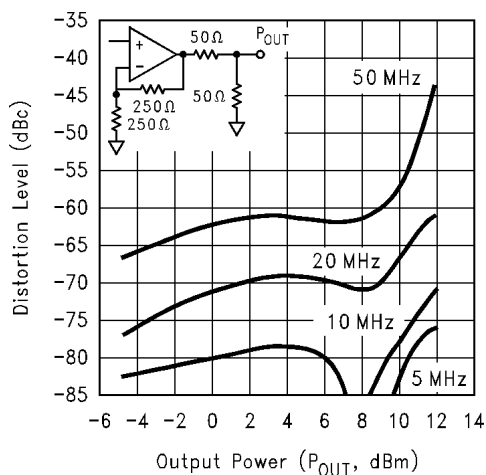

01274808

Typical D.C. Errors vs. Temperature

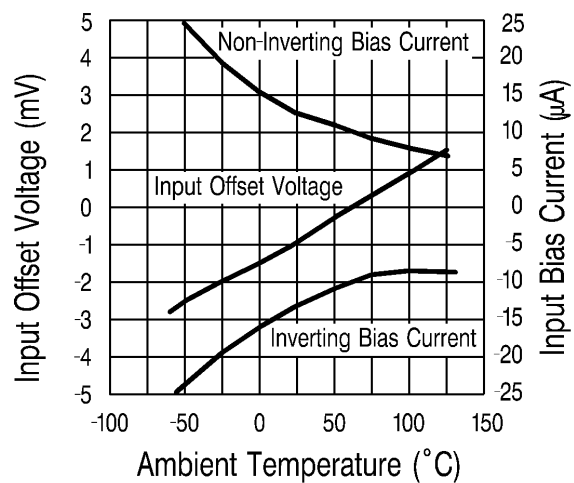

01274819

Typical Performance Characteristics ($T_A = 25^\circ\text{C}$, $A_V = +6$, $V_{CC} = \pm 5\text{V}$, $R_L = 100\Omega$, $R_f = 500\Omega$; Unless Specified). (Continued)

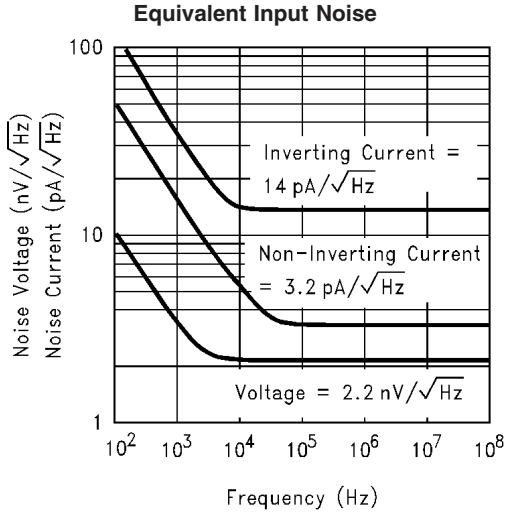

01274809

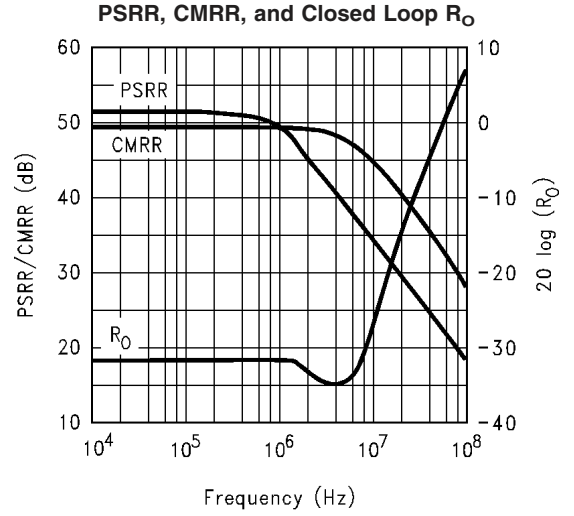

01274810

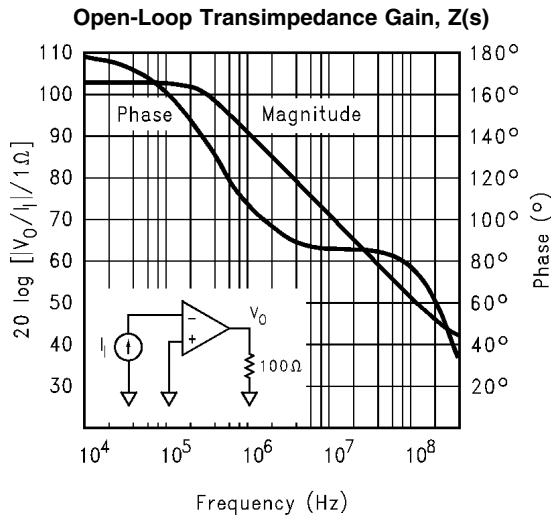

01274811

Application Division

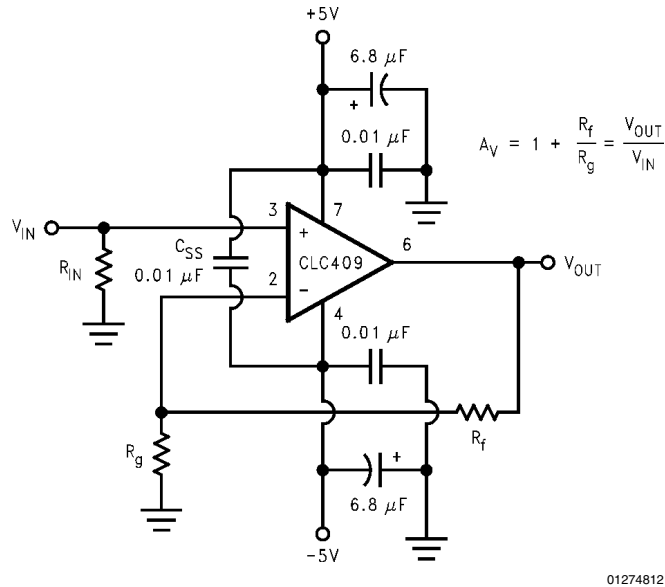

FIGURE 1. Recommended Non-Inverting Gain Circuit

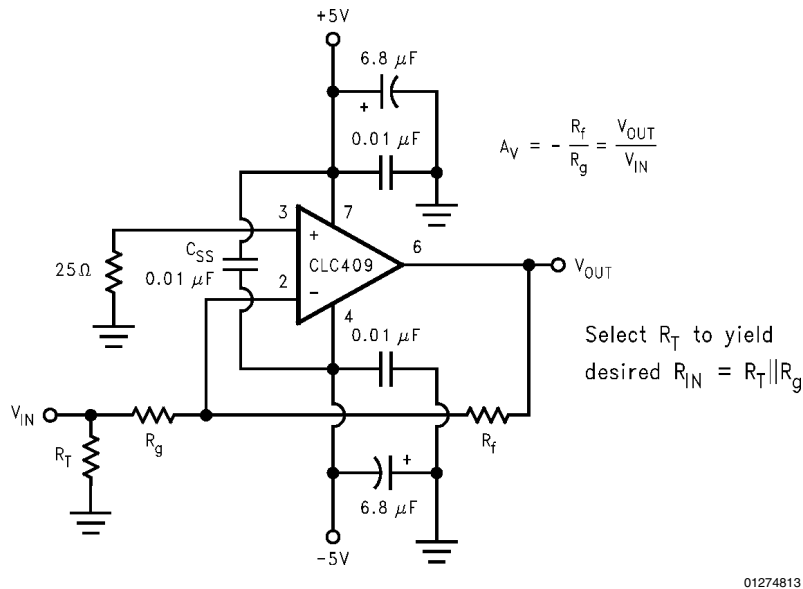

FIGURE 2. Recommended Inverting Gain Circuit

Feedback Resistor

The CLC409 achieves its excellent pulse and distortion performance by using the current feedback topology pioneered by Comlinear Corporation. The loop gain for a current feedback op amp, and hence the frequency response, is predominantly set by the feedback resistor value. The CLC409 is optimized for use with a 250Ω feedback resistor. Using lower values can lead to excessive ringing in the pulse response while a higher value will limit the bandwidth. Application Note OA-13 discusses this in detail along with the occasions where a different R_f might be advantageous.

Harmonic Distortion

The CLC409 has been optimized for exceptionally low harmonic distortion while driving very demanding resistive or capacitive loads. Generally, when used as the input amplifier to very high speed flash ADCs, the distortions introduced by the converter will dominate over the low CLC409 distortions shown on the plots on the previous page. The 0.01μF capacitor (C_{SS}) shown across the supplies in *Figure 1* and *Figure 2* is critical to achieving the lowest 2nd harmonic distortion.

The 2-tone, 3rd order spurious plot shows a relatively constant difference between the test power level and the spurious level with that difference depending on frequency. The

Application Division (Continued)

CLC409 does not show an intercept type performance. (where the relative spurious levels change at a 2X rate vs. the test tone powers), due to an internal full power bandwidth enhancement circuit that boosts the performance as the output swing increases while dissipating negligible quiescent power under low output power conditions. This feature enhances the distortion performance and full power bandwidth to match that of much higher quiescent supply current parts.

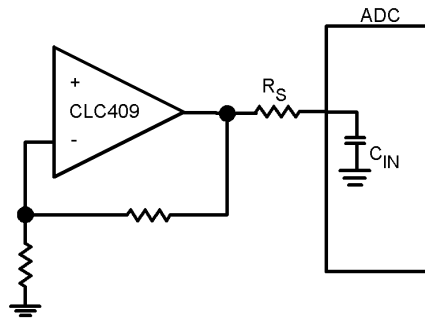

01274820

FIGURE 3. Input Amplifier to ADC

Figure 3 shows a typical application using the CLC409 to drive an ADC. The series resistor, R_s , between the amplifier output and the ADC input is critical to achieving best system performance. This load capacitance, if applied directly to the output pin, can quickly lead to unacceptable levels of ringing in the pulse response. The plot of R_s and settling time vs. C_L on the previous page is an excellent starting point for setting R_s . The value derived in that plot minimizes the step settling time into a fixed discrete capacitive load. Several additional constraints should be considered, however, in driving the capacitive input or an ADC.

There is an option to increase R_s , bandlimiting at the ADC input for either noise or Nyquist bandlimiting purposes. Increasing R_s too much, however, can induce an unacceptably large input glitch due to switching transients coupling

through from the convert signal. Also, C_{in} is oftentimes a voltage dependent capacitance. This input impedance non-linearity will induce distortion terms that will increase as R_s is increased. Only slight adjustments up or down from the recommended R_s value should therefore be attempted in optimizing system performance.

DC Accuracy and Noise

The CLC409 offers an improved offset voltage over the pin compatible CLC400 low gain amplifier. The offset adjustment available on the CLC400 was therefore not included in this part. The Output Offset equation below shows the output offset computation equation for the non-inverting configuration with an example using the typical bias current and offset specifications for $A_v = +2$.

Output Offset

$$V_O = (\pm I_{br} R_{in} \pm V_{io})(1 + R_f/R_g) \pm I_{bi} R_f$$

Example Computation for $A_v = +2$, $R_f = 250\Omega$, $R_{in} = 25\Omega$:

$$V_O = (\pm 10\mu A (25\Omega) \pm 0.5mV) 2 \pm 10\mu A (250\Omega) = \pm 3.25mV$$

This low output offset voltage is a marked improvement over earlier very high speed amplifiers. Further improvement in the output offset voltage and drift is possible using the composite amplifiers described in Application Note OA-7.

The two input bias currents are physically unrelated in both magnitude and polarity for the current feedback topology. It is not possible, therefore, to cancel their effects by matching the source impedance for the two inputs (as is commonly done for matched input bias current devices).

The total output noise is computed in a similar fashion to output offset voltage. Using the input noise voltage and two input noise currents, the output noise is developed through the same gain equations for each term but combined as the square root of the sum of squared contributing elements. See Application Note OA-12 for a full discussion of noise calculations for current feedback amplifiers.

Printed Circuit Layout

As with any high speed component, a careful attention to the board layout is necessary for optimum performance. Evaluation PC boards (CLC730013-DIP, CLC730027-SOIC, and CLC730068-SOT) for the CLC409 are available. This additional supply bypassing capacitor, C_{ss} , can easily be added to the board if desired. Further layout suggestions can be found in Application Note OA-15.

Physical Dimensions inches (millimeters)

unless otherwise noted

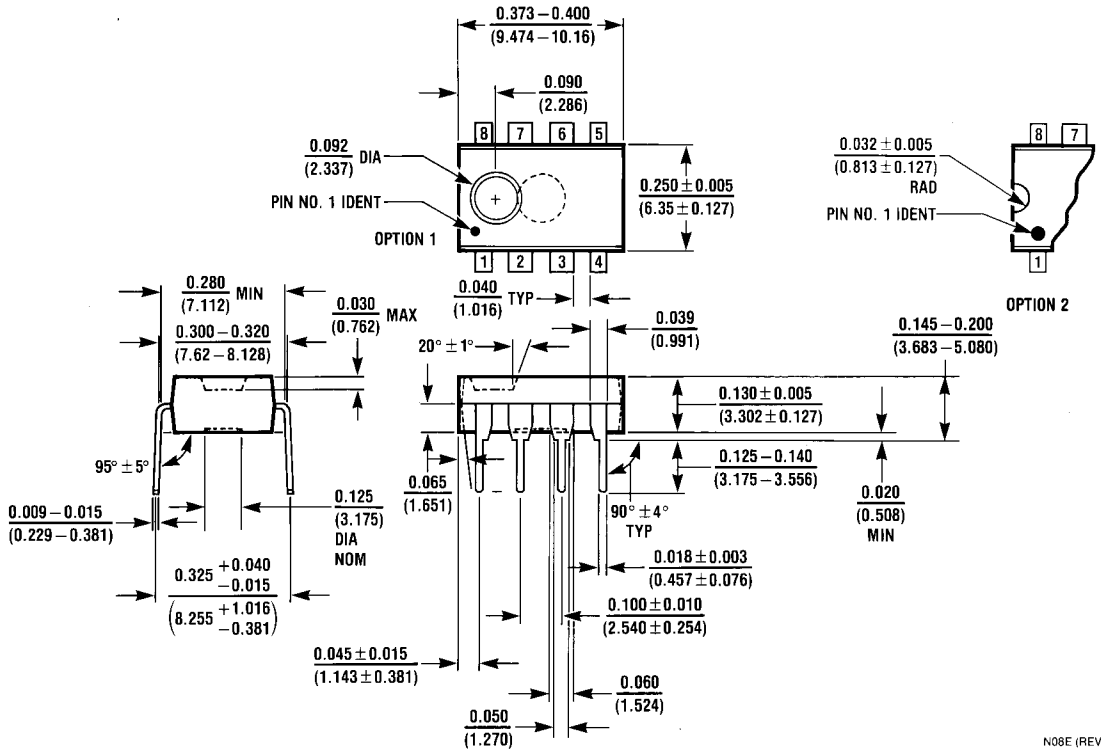

8-Pin MDIP
NS Package Number N08E

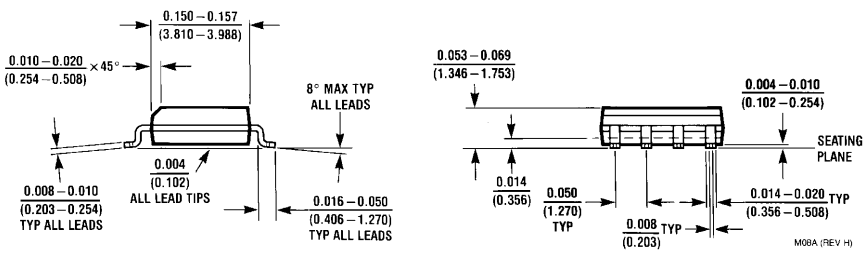
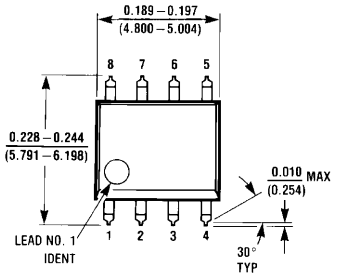

8-Pin SOIC
NS Package Number M08A

Physical Dimensions inches (millimeters) unless otherwise noted (Continued)

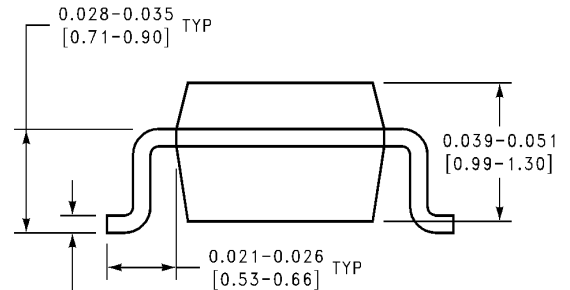
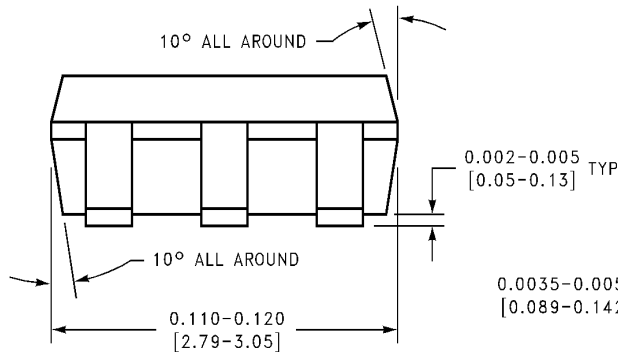
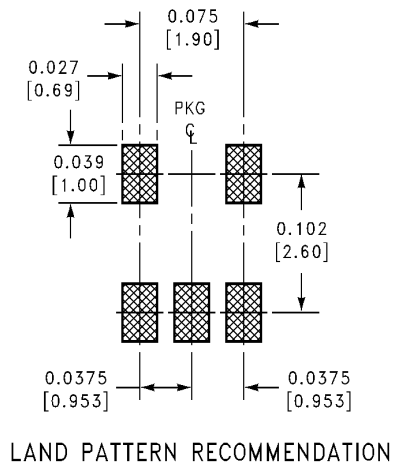
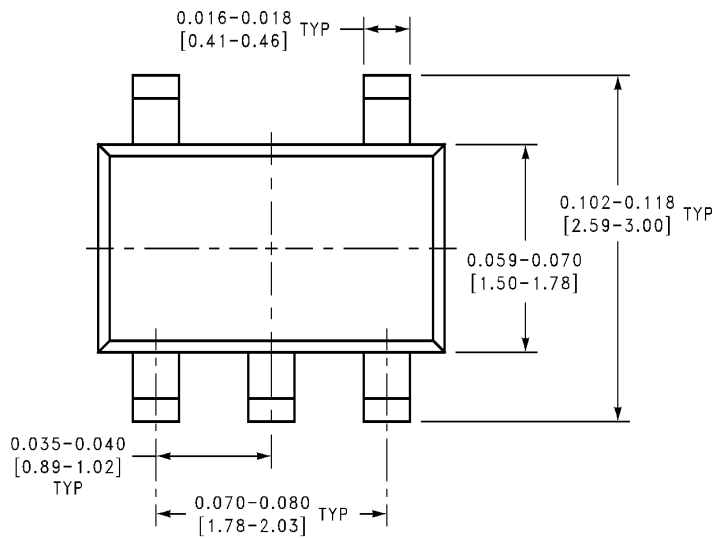

MA05A (REV D)

**5-Pin SOT23
NS Package Number MA05A**

LIFE SUPPORT POLICY

NATIONAL'S PRODUCTS ARE NOT AUTHORIZED FOR USE AS CRITICAL COMPONENTS IN LIFE SUPPORT DEVICES OR SYSTEMS WITHOUT THE EXPRESS WRITTEN APPROVAL OF THE PRESIDENT AND GENERAL COUNSEL OF NATIONAL SEMICONDUCTOR CORPORATION. As used herein:

1. Life support devices or systems are devices or systems which, (a) are intended for surgical implant into the body, or (b) support or sustain life, and whose failure to perform when properly used in accordance with instructions for use provided in the labeling, can be reasonably expected to result in a significant injury to the user.
2. A critical component is any component of a life support device or system whose failure to perform can be reasonably expected to cause the failure of the life support device or system, or to affect its safety or effectiveness.

 **National Semiconductor Corporation**
Americas
Email: support@nsc.com

www.national.com

National Semiconductor Europe
Fax: +49 (0) 180-530 85 86
Email: europe.support@nsc.com
Deutsch Tel: +49 (0) 69 9508 6208
English Tel: +44 (0) 870 24 0 2171
Français Tel: +33 (0) 1 41 91 8790

National Semiconductor Asia Pacific Customer Response Group
Tel: 65-2544466
Fax: 65-2504466
Email: ap.support@nsc.com

National Semiconductor Japan Ltd.
Tel: 81-3-5639-7560
Fax: 81-3-5639-7507