

FSK Radio Receiver Module

RC-RFSK1-868 is an FSK Radio Receiver Module with PLL Synthesizer and crystal oscillator. Single Line Package with power down mode and RSSI Output.

Frequency : 868.35MHz
RF Sensitivity = 100dBm

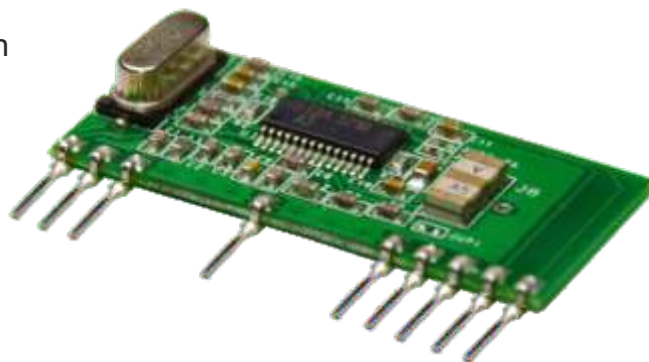

Applications :

- Wireless security systems
- Home and building automation
- Automatic Measure Reading
- Wireless Sensor Network

Technical Characteristics

Characteristics	MIN	TYP	MAX	UNIT
V _{cc} Supply Voltage	4.5		5.5	Vdc
I _s Supply Current (Operation mode)		5.7	6.8	mA
I _s Supply Current (Shut down mode)			100	nA
F Frequency		868.35		MHz
D Max Data Rate			4.8	Kbit/s
S RF Sensitivity		100		dBm
B 3dB Bandwith		± 150		KHz
L Level of emitted spectrum			70	dBm
T Power Up Time (from Power to stable data)			8	ms
T1 Power Up Time1 (from PD to stable data)			5	ms
TE Operating Temperature Range	-25		+80	°C

Pin Description

Pads	Name	Description
1	VCC	Vcc Power
2	GND	Ground
3	IN	Antenna
7	GND	Ground
11	GND	Ground
12	NC	Not connected
13	RSSI	Received Signal Strenght Output
14	OUT	Data Out
15	PD	Power down

PD = LOW ----> RX OFF
PD = HIGH ----> RX ON

Mechanical Dimensions

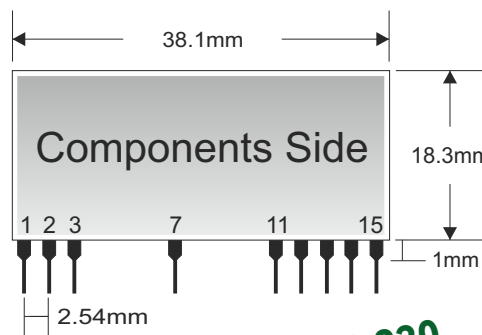

**ETSI EN 300 220
COMPLIANCE**

RSSI Output

The RSSI provides a DC Voltage proportional to the peak value of the receive data signal. This output can be used as an indicator for the received signal strength to use in wake-up circuits and other application.

RF IN (dBm)	RSSI (Volt)
- 120 dBm	1.20 Volt
- 110 dBm	1.32 Volt
- 100 dBm	1.50 Volt
- 90 dBm	1.78 Volt
- 80 dBm	2.06 Volt
- 70 dBm	2.35 Volt
- 60 dBm	2.62 Volt
- 50 dBm	2.72 Volt
- 40 dBm	2.75 Volt

Typical application

