

9001KR16H2

Harmony 9001K, emergency stop push-button, metal, mushroom 40mm, red, 30mm, 2 positions, turn to release, 2 C/O



Main

Range of Product	Harmony 9001K
Product or Component Type	Emergency stop push-button
Device short name	9001K
Type of operator	Turn to release trigger action
Operator profile	Red mushroom Ø 40 mm, unmarked

Complementary

Bezel material	Metal
Mounting diameter	1.18 in (30 mm)
CAD overall width	1.57 in (40 mm)
CAD overall height	1.57 in (40 mm)
CAD overall depth	4.57 in (116 mm)
Net Weight	0.31 lb(US) (0.141 kg)
Operating position	Any position
Shape of signaling unit head	Round
Head material	Plastic
Operator position information	2 positions
Contacts type and composition	2 C/O
Mechanical durability	5000000 cycles
Connections - terminals	Screw clamp terminals, 1 x 0.22...2 x 1.5 mm ² EN/IEC 60947-1
Tightening torque	7.08 lbf.in (0.8 N.m) EN/IEC 60947-1
Shape of screw head	Cross slotted
Contacts material	Silver alloy contacts
Short-circuit protection	10 A cartridge fuse EN/IEC 60947-5-1
[I _{th}] conventional free air thermal current	10 A
[U _i] rated insulation voltage	250 V 3)EN/IEC 60947-1
[U _{imp}] rated impulse withstand voltage	2.5 kV EN/IEC 60947-1
[I _e] rated operational current	3 A 240 V, AC-15, A600-Q600 NEMA 0.55 A 125 V, DC-13, A600-Q600 NEMA
[I _{cm}] rated short-circuit making capacity	12 KA 120 V AC-15, 7200 VA 0.1 KA 600 V DC-13 0.27 KA 250 V DC-13 0.55 KA 125 V DC-13
Rated breaking capacity	3 KA 240 V AC-15, 720 VA 6 KA 120 V AC-15, 720 VA 1.2 KA 600 V AC-15, 720 VA 1.5 KA 480 V AC-15, 720 VA 0.1 KA 600 V DC-13 0.27 KA 250 V DC-13 0.55 KA 125 V DC-13
Device presentation	Complete product

The information provided in this documentation contains general descriptions and/or technical characteristics of the performance of the products contained herein. This documentation is not intended as a substitute for and is not to be used for determining suitability or reliability of these products for specific user applications. It is the duty of any such user or integrator to perform the appropriate and complete risk analysis, evaluation and testing of the products with respect to the relevant specific application or use thereof. Neither Schneider Electric Industries SAS nor any of its affiliates or subsidiaries shall be responsible or liable for misuse of the information contained herein.

Environment

Protective treatment	TC
Ambient Air Temperature for Storage	-40...158 °F (-40...70 °C)
Ambient Air Temperature for Operation	-13...158 °F (-25...70 °C)
Overvoltage category	Class II IEC 61140
IP degree of protection	IP66 IEC 60529
NEMA degree of protection	NEMA 1 NEMA 12 NEMA 13 NEMA 2 NEMA 3 NEMA 3R NEMA 4 NEMA 6
Standards	EN/IEC 60204-1, for emergency stop devices if used with emergency stop legend plate type 9001KN EN/ISO 13850, for emergency stop devices if used with emergency stop legend plate type 9001KN EN/IEC 60947-5-1 EN/IEC 60947-1 EN/IEC 60947-5-4 EN/IEC 60947-5-5 JIS C 4520 JIS C 852 UL 508 CSA C22.2 No 14
Product Certifications	NEMA UL 508
Vibration resistance	7 gn 2...500 Hz)IEC 60068-2-6
Shock resistance	50 gn IEC 60068-2-27





Ordering and shipping details

Category	21426-9001 K (NOT KA,KM,KX)
Discount Schedule	CS1
GTIN	785901623595
Nbr. of units in pkg.	1
Package weight(Lbs)	8.00 oz (226.8 g)
Returnability	Yes
Country of origin	MX

Packing Units

Unit Type of Package 1	PCE
Package 1 Height	2.01 in (5.1 cm)
Package 1 width	2.40 in (6.1 cm)
Package 1 Length	4.49 in (11.4 cm)

Offer Sustainability

Sustainable offer status	Green Premium product
California proposition 65	WARNING: This product can expose you to chemicals including: Lead and lead compounds, which is known to the State of California to cause cancer and birth defects or other reproductive harm. For more information go to www.P65Warnings.ca.gov
REACH Regulation	 REACH Declaration
EU RoHS Directive	Pro-active compliance (Product out of EU RoHS legal scope)  EU RoHS Declaration
Mercury free	Yes
RoHS exemption information	 Yes
China RoHS Regulation	 China RoHS Declaration

Environmental Disclosure	Product Environmental Profile
WEEE	The product must be disposed on European Union markets following specific waste collection and never end up in rubbish bins.

Contractual warranty

Warranty	18 months
----------	-----------

Dimensions

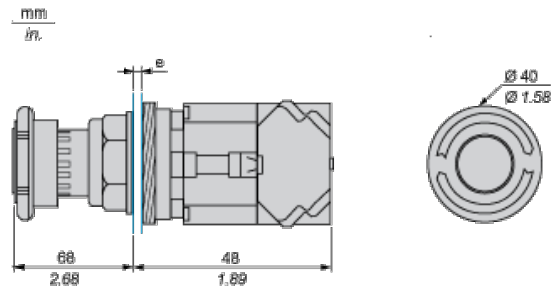

e panel thickness: 1 to 6 mm / 0.04 to 0.24 in.

Contact Block Mounting Position

Top and Rear views

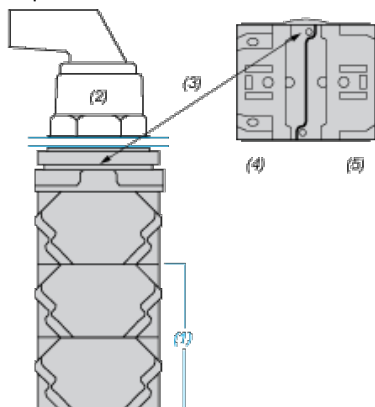

- (1) It is possible to mount up to 3 levels of contacts blocks (maximum of 6 contacts blocks)
- (2) Operator
- (3) Locating notch
- (4) Side 1
- (5) Side 2

Panel Cut-Out

Clearance

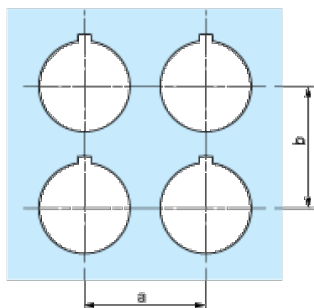

Legend plate	a min.		b min.	
	mm	in.	mm	in.
9001KN2••	57.2	2.25	44.5	1.75
9001KN3••	57.2	2.25	50.8	2.00

Individual Cut-outs Details

2 alternatives

