

63662-1 ✓ ACTIVE

MAG-MATE

TE Internal #: 63662-1

Magnet Wire Terminals, Poke-In, Size 2, Lead Wire Size 20 – 18

AWG, Lead Wire Size .5 – .9 mm², .16 – .18 mm Magnet Wire, MAG-MATE

[View on TE.com >](#)



Terminals & Splices > Magnet Wire Terminals



Magnet Wire Terminal Type: **Poke-In**

Compatible With Cavity Size: **Size 2**

Lead Wire Size: **.5 – .9 mm²**

Magnet Wire Size: **34 – 33 AWG**

Features

Product Type Features

Compatible With Discrete Wire Type

Magnet Wire, Solid

Body Features

Compatible With Cavity Size

Size 2

Contact Features

Magnet Wire Terminal Type

Poke-In

Terminal Plating Material

Tin

Terminal Orientation

Twisted

Termination Features

Termination Method to Wire & Cable

Insulation Displacement (IDC)

Mechanical Attachment

Mating Retention Type

Locking

Dimensions

Terminal Height

7.62 mm [.3 in]

Lead Wire Size

.5 – .9 mm²



Magnet Wire Size	.16 – .18 mm
------------------	--------------

Product Length	7.87 mm [.309 in]
----------------	-------------------

Usage Conditions

Insulation Option	Uninsulated
-------------------	-------------

Operating Temperature Range	-65 – 150 °C [-85 – 302 °F]
-----------------------------	-----------------------------

Operation/Application

Compatible With Wire Base Material	Copper
------------------------------------	--------

Identification Marking

Identification Number	3
-----------------------	---

Packaging Features

Packaging Quantity	12000
--------------------	-------

Packaging Method	Reel, Reel/Carton
------------------	-------------------

Other

Terminals & Splices Comment	Solid or overcoated stranded lead wire only., Two magnet wires may be terminated in the same terminal slot if diameters are equal.
-----------------------------	--

Product Compliance

[For compliance documentation, visit the product page on TE.com>](#)

EU RoHS Directive 2011/65/EU	Compliant
------------------------------	-----------

EU ELV Directive 2000/53/EC	Compliant
-----------------------------	-----------

China RoHS 2 Directive MIIT Order No 32, 2016	No Restricted Materials Above Threshold
---	---

EU REACH Regulation (EC) No. 1907/2006	Current ECHA Candidate List: JUNE 2023 (235) Candidate List Declared Against: JUNE 2023 (235) Does not contain REACH SVHC
--	---

Halogen Content	Low Halogen - Br, Cl, F, I < 900 ppm per homogenous material. Also BFR/CFR/PVC Free
-----------------	---













Solder Process Capability	Not applicable for solder process capability
---------------------------	--

Product Compliance Disclaimer

This information is provided based on reasonable inquiry of our suppliers and represents our current actual knowledge based on the information they provided. This information is subject to change. The part numbers that TE has identified as EU RoHS compliant have a maximum concentration of 0.1% by weight in homogenous materials for lead, hexavalent chromium, mercury, PBB, PBDE, DBP, BBP, DEHP, DIBP, and 0.01% for cadmium, or qualify for an exemption to these

limits as defined in the Annexes of Directive 2011/65/EU (RoHS2). Finished electrical and electronic equipment products will be CE marked as required by Directive 2011/65/EU. Components may not be CE marked. Additionally, the part numbers that TE has identified as EU ELV compliant have a maximum concentration of 0.1% by weight in homogenous materials for lead, hexavalent chromium, and mercury, and 0.01% for cadmium, or qualify for an exemption to these limits as defined in the Annexes of Directive 2000/53/EC (ELV). Regarding the REACH Regulation, the information TE provides on SVHC in articles for this part number is based on the latest European Chemicals Agency (ECHA) 'Guidance on requirements for substances in articles' posted at this URL: <https://echa.europa.eu/guidance-documents/guidance-on-reach>

Compatible Parts

 <p>TE Part # 1217234-1 MAG-MATE TERM 28-31 013TPBR</p>	 <p>TE Part # 62833-1 MAG-MATE POKE-IN TERM 016TPBR</p>	 <p>TE Part # 63658-1 MAG MATE TERM 25-22 016TPBR</p>	 <p>TE Part # 62527-1 MAG-MATE TERM 31-32 010 TPBR</p>
 <p>TE Part # 63591-1 MAG-MATE TERM #20 016TPBR</p>	 <p>TE Part # 1742379-1 TERMINAL,POKE-IN,MAG-MATE</p>	 <p>TE Part # 62833-2 MAG-MATE POKE-IN TERM 016TPBR</p>	 <p>TE Part # 62833-4 TERMINAL,POKE-IN,MAG-MATE</p>
 <p>TE Part # 62912-1 MAG-MATE POKE-IN 016 TPBR</p>	 <p>TE Part # 63658-2 MAG-MATE TERM 25-22 016 TPBR</p>	 <p>TE Part # 63044-1 MAG-MATE TERM 27-23 016 TPBR</p>	 <p>TE Part # 63569-1 MAG-MATE 048 PIN 28-31 010TPBR</p>
 <p>TE Part # 1217026-1 MAG-MATE TERM 31-32 010 TPBR</p>	 <p>TE Part # 63570-1 MAG-MATE 048 PIN 23-27 TPBR</p>		

Also in the Series | **MAG-MATE**

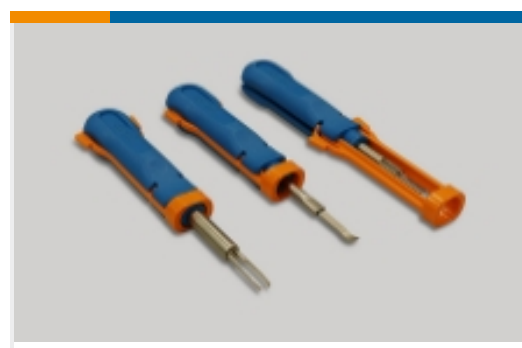

Insertion & Extraction Tools(7)



Magnet Wire Terminals(435)

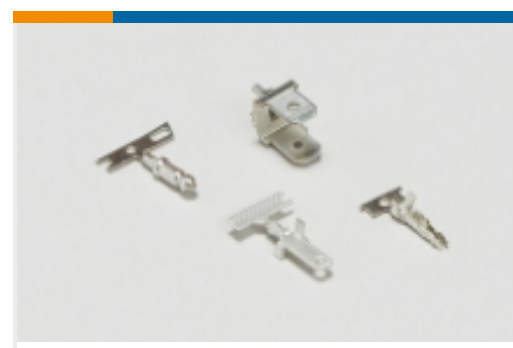

PCB Terminals(1)

Customers Also Bought

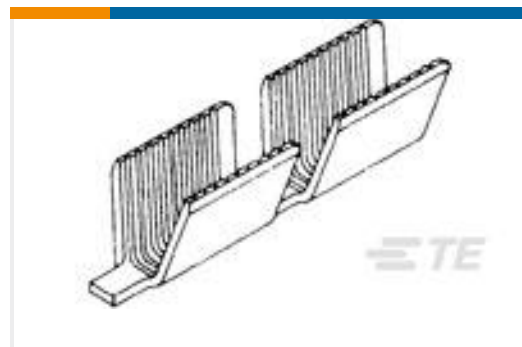
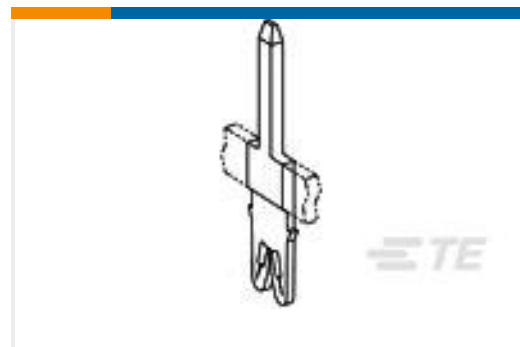
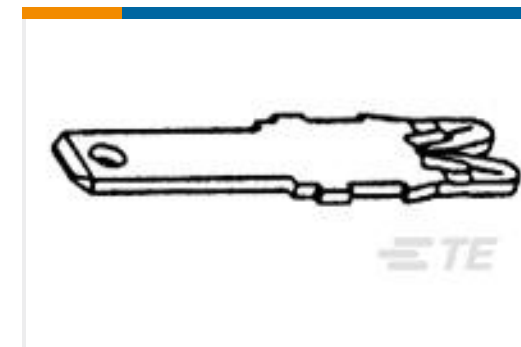
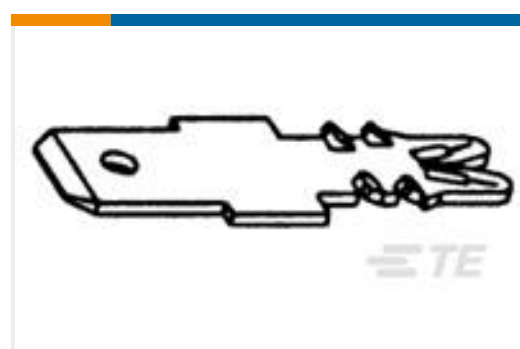
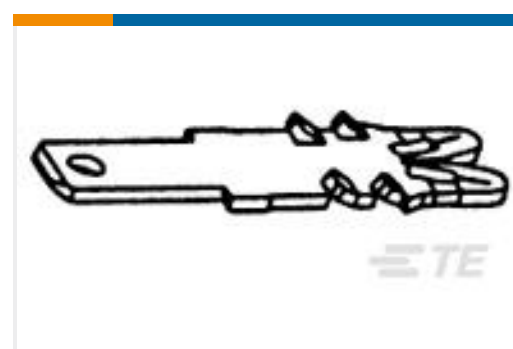
TE Part #62309-2
AMVAR SPLC 5000-10000 025TPBRTE Part #2-1601110-2
131-182-014=TAB,1.2X.81,STDMSZTE Part #2238060-1
MAG-MATE POST 33-31 CU / 31-29 AL TPBRTE Part #4-1601045-1
031-093-000=TAB,110X020,STDMSZTE Part #4-280050-1
250 FASTON,FLAG,REC.,16-20 AWG, BRTE Part #1601040-1
SIAMEZE TERMINALSTE Part #1601119-2
118X 025 TAB FINE WIRE SIAMEZETE Part #2238088-1
MAG-MATE TAB 33-31 CU / 31-29 AL TPBR

Documents

Product Drawings

[MAG-MATE TERM 33-34 010TPBR](#)

English

CAD Files

[3D PDF](#)

3D

Customer View Model

[ENG_CVM_CVM_63662-1_K.2d_dxf.zip](#)

English

Customer View Model

[ENG_CVM_CVM_63662-1_K.3d_igs.zip](#)

English

Customer View Model

[ENG_CVM_CVM_63662-1_K.3d_stp.zip](#)

English

By downloading the CAD file I accept and agree to the [Terms and Conditions](#) of use.



Datasheets & Catalog Pages

Magnet Wire Terminals & Splices

English

Product Specifications

Application Specification

English

Product Environmental Compliance

Product Compliance

English

Product Compliance

English