



# Ultrasound Variable-Gain Amplifier

MAX2037

## General Description

The MAX2037 8-channel variable-gain amplifier (VGA) is designed for high linearity, high dynamic range, and low-noise performance targeting ultrasound imaging and Doppler applications. Each amplifier features differential inputs and outputs and a total gain range of typically 42dB. In addition, the VGAs offer very low output-referred noise performance suitable for interfacing with 12-bit ADCs.

The MAX2037 VGA is optimized for less than  $\pm 0.25\text{dB}$  absolute gain error to ensure minimal channel-to-channel ultrasound beamforming focus error. The device's differential outputs are designed to directly drive ultrasound ADCs through an external passive anti-aliasing filter. A switchable clamp is also provided at each amplifier's outputs to limit the output signals, thereby preventing ADC overdrive or saturation.

Dynamic performance of the device is optimized to reduce distortion to support second-harmonic imaging. The device achieves a second-harmonic distortion specification of  $-70\text{dBc}$  at  $V_{\text{OUT}} = 1.5\text{V}_{\text{P-P}}$  and  $f_{\text{IN}} = 5\text{MHz}$ , and an ultrasound-specific\* two-tone third-order intermodulation distortion specification of  $-52\text{dBc}$  at  $V_{\text{OUT}} = 1.5\text{V}_{\text{P-P}}$  and  $f_{\text{IN}} = 5\text{MHz}$ .

The MAX2037 operates from a  $+5.0\text{V}$  power supply, consuming only  $120\text{mW}/\text{channel}$ . The device is available in a 100-pin TQFP package with an exposed pad. Electrical performance is guaranteed over a  $0^\circ\text{C}$  to  $+70^\circ\text{C}$  temperature range.

## Applications

Ultrasound Imaging      Sonar

## Functional Diagram

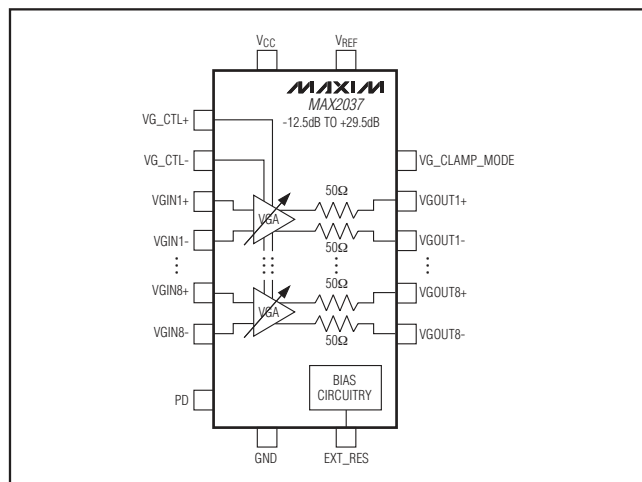

## Features

- ◆ 8-Channel Configuration
- ◆ High Integration for Ultrasound Imaging Applications
- ◆ Pin Compatible with the MAX2038 Ultrasound VGA Plus CW Doppler Beamformer
- ◆ Maximum Gain, Gain Range, and Output-Referred Noise Optimized for Interfacing with 12-Bit ADCs
  - Maximum Gain of 29.5dB
  - Total Gain Range of 42dB
  - 22nV/ $\sqrt{\text{Hz}}$  Ultra-Low Output-Referred Noise at 5MHz
  - Pin-for-Pin 10-Bit Compatibility Supported By MAX2035/MAX2036
- ◆  $\pm 0.25\text{dB}$  Absolute Gain Error
- ◆ Switchable Output VGA Clamp Eliminating ADC Overdrive
- ◆ Fully Differential VGA Outputs for Direct ADC Drive
- ◆ Variable Gain Range Achieves 42dB Dynamic Range
- ◆  $-70\text{dBc}$  HD2 at  $V_{\text{OUT}} = 1.5\text{V}_{\text{P-P}}$  and  $f_{\text{IN}} = 5\text{MHz}$
- ◆ Two-Tone Ultrasound-Specific\* IMD3 of  $-52\text{dBc}$  at  $V_{\text{OUT}} = 1.5\text{V}_{\text{P-P}}$  and  $f_{\text{IN}} = 5\text{MHz}$
- ◆ 120mW Consumption Per Channel

\*See the Ultrasound-Specific IMD3 Specification in the Applications Information section.

## Ordering Information

PART	TEMP RANGE	PIN-PACKAGE
MAX2037CCQ+D	$0^\circ\text{C}$ to $+70^\circ\text{C}$	100 TQFP-EP†
MAX2037CCQ+TD	$0^\circ\text{C}$ to $+70^\circ\text{C}$	100 TQFP-EP†

†EP = Exposed pad.

+Denotes a lead(Pb)-free/RoHS-compliant package.

T = Tape and reel.

D = Dry packing.



# Ultrasound Variable-Gain Amplifier

## ABSOLUTE MAXIMUM RATINGS

V<sub>CC</sub>, V<sub>REF</sub> to GND .....-0.3V to +5.5V  
 Any Other Pins to GND.....-0.3V to (V<sub>CC</sub> + 0.3V)  
 VGA Differential Input Voltage (V<sub>GIN+</sub> - V<sub>GIN-</sub>).....8.0V<sub>P-P</sub>  
 Analog Gain-Control Input Differential Voltage  
 (V<sub>G\_CTL+</sub> - V<sub>G\_CTL-</sub>).....8.0V<sub>P-P</sub>  
 Continuous Power Dissipation (T<sub>A</sub> = +70°C)  
 100-Pin TQFP  
 (derated 45.5mW/°C above +70°C).....3636.4mW

Operating Temperature Range.....0°C to +70°C  
 Junction Temperature.....+150°C  
 θ<sub>JC</sub> (Note 1) .....+2°C/W  
 θ<sub>JA</sub> (Note 1) .....+22°C/W  
 Storage Temperature Range .....-40°C to +150°C  
 Lead Temperature (soldering, 10s).....+300°C

**Note 1:** Package thermal resistances were obtained using the method described in JEDEC specification JESD51-7, using a four-layer board. For detailed information on package thermal considerations, refer to [www.maxim-ic.com/thermal-tutorial](http://www.maxim-ic.com/thermal-tutorial).

Stresses beyond those listed under "Absolute Maximum Ratings" may cause permanent damage to the device. These are stress ratings only, and functional operation of the device at these or any other conditions beyond those indicated in the operational sections of the specifications is not implied. Exposure to absolute maximum rating conditions for extended periods may affect device reliability.

## DC ELECTRICAL CHARACTERISTICS

(Figure 2, V<sub>CC</sub> = V<sub>REF</sub> = 4.75V to 5.25V, V<sub>CM</sub> = (3/5)V<sub>REF</sub>, T<sub>A</sub> = 0°C to +70°C, V<sub>GND</sub> = 0, PD = 0, no RF signals applied, capacitance to GND at each of the VGA differential outputs is 60pF, differential capacitance across the VGA outputs is 10pF, R<sub>L</sub> = 1kΩ. Typical values are at V<sub>CC</sub> = V<sub>REF</sub> = 5V, T<sub>A</sub> = +25°C, unless otherwise noted.) (Note 2)

PARAMETER	SYMBOL	CONDITIONS	MIN	TYP	MAX	UNITS
Supply Voltage Range	V <sub>CC</sub>		4.75	5	5.25	V
V <sub>CC</sub> External Reference Voltage Range	V <sub>REF</sub>	(Note 3)	4.75	5	5.25	V
Total Power Supply Current		Refers to V <sub>CC</sub> supply current plus V <sub>REF</sub> current		204	231	mA
				27	33	
V <sub>CC</sub> Supply Current	I <sub>VCC</sub>			192	216	mA
V <sub>REF</sub> Current	I <sub>REF</sub>			12	15	mA
Current Consumption per Amplifier Channel		Refers to V <sub>CC</sub> supply current		24	27	mA
Differential Analog Control Voltage Range		Minimum gain		+2		V <sub>P-P</sub>
		Maximum gain		-2		
Differential Analog Control Common-Mode Voltage	V <sub>CM</sub>		2.85	3.0	3.15	V
Analog Control Input Source/Sink Current				4.5	5	mA
<b>LOGIC INPUTS</b>						
CMOS Input High Voltage	V <sub>IH</sub>		2.0			V
CMOS Input Low Voltage	V <sub>IL</sub>				0.8	V

# Ultrasound Variable-Gain Amplifier

MAX2037

## AC ELECTRICAL CHARACTERISTICS

(Figure 2,  $V_{CC} = V_{REF} = 4.75V$  to  $5.25V$ ,  $V_{CM} = (3/5)V_{REF}$ ,  $T_A = 0^\circ C$  to  $+70^\circ C$ ,  $V_{GND} = 0$ ,  $PD = 0$ ,  $VG\_CLAMP\_MODE = 1$ ,  $f_{RF} = 5MHz$ , capacitance to GND at each of the VGA differential outputs is  $60pF$ , differential capacitance across the VGA outputs is  $10pF$ ,  $R_L = 1k\Omega$ . Typical values are at  $V_{CC} = V_{REF} = 5V$ ,  $T_A = +25^\circ C$ , unless otherwise noted.) (Note 2)

PARAMETER	SYMBOL	CONDITIONS		MIN	TYP	MAX	UNITS
Full-Scale Bandwidth	f-1.3dB	$V_{OUT} = 1.5V_{P-P}$ , 3dB bandwidth, gain = 10dB	Differential output capacitance is $10pF$ , capacitance to GND at each single-ended output is $60pF$ , $R_L = 1k\Omega$		18		MHz
			No capacitive load $R_L = 1k\Omega$		29		
Small Signal Bandwidth	f-1.3dB	$V_{OUT} = 1.5mV_{P-P}$ , 3dB bandwidth, gain = 10dB			30		MHz
Differential Input Resistance	$R_{IN}$			170	200	230	$\Omega$
Input Effective Capacitance	$C_{IN}$	$f_{RF} = 10MHz$ , each input to ground			15		pF
Differential Output Resistance	$R_{OUT}$				100		$\Omega$
Maximum Gain					+29.5		dB
Minimum Gain					-12.5		dB
Gain Range					42		dB
Absolute Gain Error		$T_A = +25^\circ C$ , full gain range 0% to 100%, $V_{REF} = 5V$			$\pm 0.25$	$\pm 1.5$	dB
VGA Gain Response Time		40dB gain change to within 1dB final value			1		$\mu s$
Input-Referred Noise		$VG\_CTL$ set for maximum gain, no input signal			2		$nV/\sqrt{Hz}$
Output-Referred Noise		$VG\_CTL$ set for +10dB of gain	No input signal		22		$nV/\sqrt{Hz}$
			$V_{OUT} = 1.5V_{P-P}$ , 1kHz offset		55		
Second Harmonic	HD2	$VG\_CLAMP\_MODE = 1$ , $VG\_CTL$ set for +10dB of gain, $f_{RF} = 5MHz$ , $V_{OUT} = 1.5V_{P-P}$			-70		dBc
		$VG\_CLAMP\_MODE = 1$ , $VG\_CTL$ set for +10dB of gain, $f_{RF} = 10MHz$ , $V_{OUT} = 1.5V_{P-P}$		-55	-65		
Third-Order Intermodulation Distortion	IMD3	$VG\_CLT$ set for +10dB of gain, $f_{RF1} = 5MHz$ , $f_{RF2} = 5.01MHz$ , $V_{OUT} = 1.5V_{P-P}$ , $V_{REF} = 5V$ (Note 4)		-40	-52		dBc

# Ultrasound Variable-Gain Amplifier

## AC ELECTRICAL CHARACTERISTICS (continued)

(Figure 2,  $V_{CC} = V_{REF} = 4.75V$  to  $5.25V$ ,  $V_{CM} = (3/5)V_{REF}$ ,  $T_A = 0^\circ C$  to  $+70^\circ C$ ,  $V_{GND} = 0$ ,  $PD = 0$ ,  $VG\_CLAMP\_MODE = 1$ ,  $f_{RF} = 5MHz$ , capacitance to GND at each of the VGA differential outputs is  $60pF$ , differential capacitance across the VGA outputs is  $10pF$ ,  $R_L = 1k\Omega$ . Typical values are at  $V_{CC} = V_{REF} = 5V$ ,  $T_A = +25^\circ C$ , unless otherwise noted.) (Note 2)

PARAMETER	SYMBOL	CONDITIONS	MIN	TYP	MAX	UNITS
Channel-to-Channel Crosstalk		$V_{OUT} = 1V_{P-P}$ differential, $f_{RF} = 10MHz$ , $VG\_CTL$ set for $+10dB$ of gain		-80		dB
Maximum Output Voltage at Clamp ON		$VG\_CLAMP\_MODE = 0$ , $VG\_CTL$ set for $+20dB$ of gain, $350mV_{P-P}$ differential input		2.4		$V_{P-P}$ differential
Maximum Output Voltage at Clamp OFF		$VG\_CLAMP\_MODE = 1$ , $VG\_CTL$ set for $+20dB$ of gain, $350mV_{P-P}$ differential input		2.8		$V_{P-P}$ differential

**Note 2:** Specifications at  $T_A = +25^\circ C$  and  $T_A = +70^\circ C$  are guaranteed by production test. Specifications at  $T_A = 0^\circ C$  are guaranteed by design and characterization.

**Note 3:** Noise performance of the device is dependent on the noise contribution from the supply to  $V_{REF}$ . Use a low noise supply for  $V_{REF}$ .  $V_{CC}$  and  $V_{REF}$  can be connected together to share the same supply voltage if the supply for  $V_{CC}$  exhibits low noise.

**Note 4:** See the *Ultrasound-Specific IMD3 Specification* in the *Applications Information* section.

## Typical Operating Characteristics

(Figure 2,  $V_{CC} = V_{REF} = 4.75V$  to  $5.25V$ ,  $V_{GND} = 0$ ,  $PD = 0$ ,  $VG\_CLAMP\_MODE = 1$ ,  $f_{RF} = 5MHz$ , capacitance to GND at each of the VGA differential outputs is  $60pF$ , differential capacitance across the VGA outputs is  $10pF$ ,  $R_L = 1k\Omega$ ,  $T_A = 0^\circ C$  to  $+70^\circ C$ . Typical values are at  $V_{CC} = V_{REF} = 5V$ ,  $T_A = +25^\circ C$ , unless otherwise noted.)

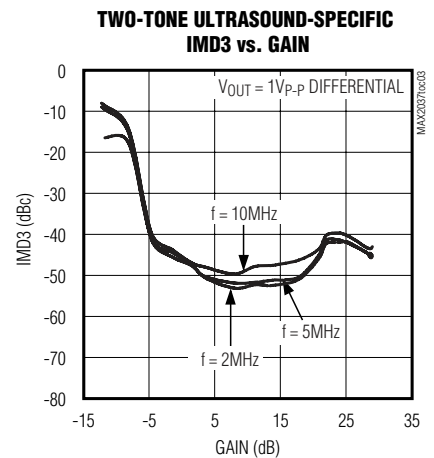
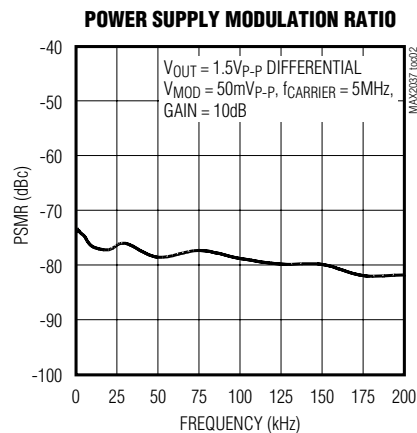
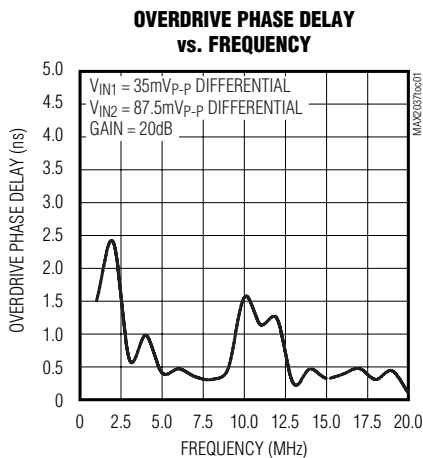

# Ultrasound Variable-Gain Amplifier

MAX2037

## Typical Operating Characteristics (continued)

(Figure 2,  $V_{CC} = V_{REF} = 4.75V$  to  $5.25V$ ,  $V_{GND} = 0$ ,  $PD = 0$ ,  $VG\_CLAMP\_MODE = 1$ ,  $f_{RF} = 5MHz$ , capacitance to GND at each of the VGA differential outputs is  $60pF$ , differential capacitance across the VGA outputs is  $10pF$ ,  $R_L = 1k\Omega$ ,  $T_A = 0^\circ C$  to  $+70^\circ C$ . Typical values are at  $V_{CC} = V_{REF} = 5V$ ,  $T_A = +25^\circ C$ , unless otherwise noted.)

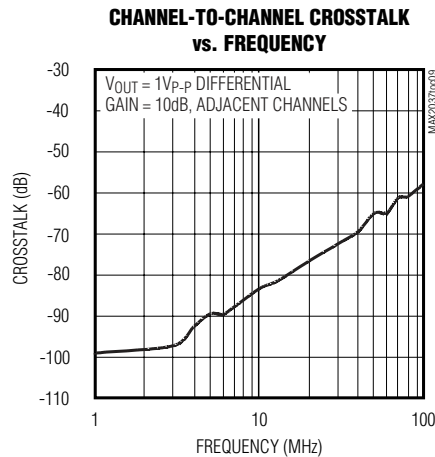
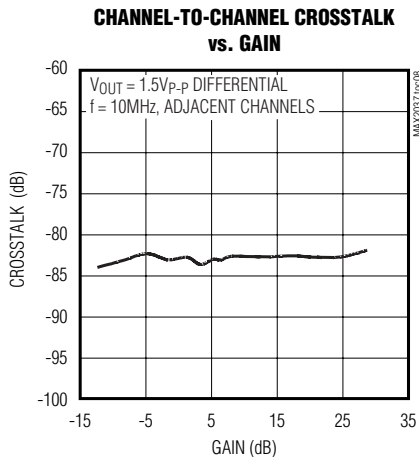
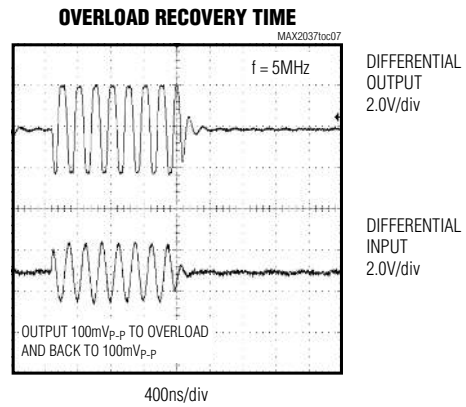
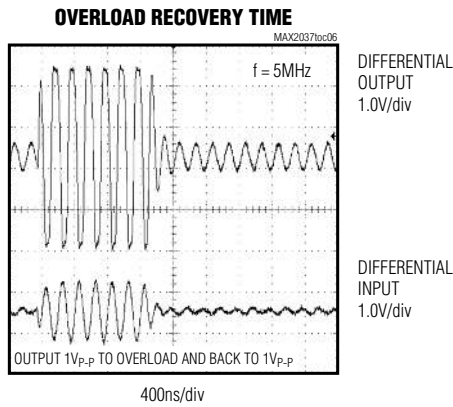
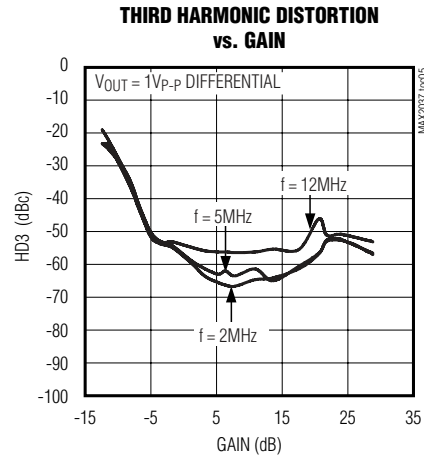
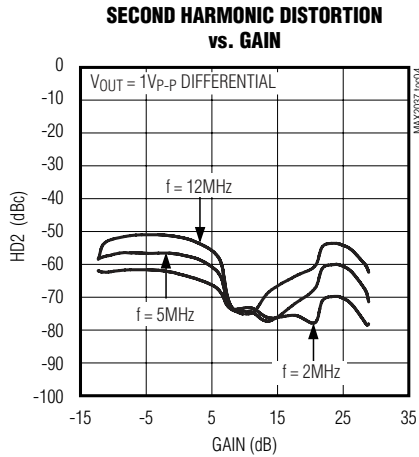

# Ultrasound Variable-Gain Amplifier

## Typical Operating Characteristics (continued)

(Figure 2,  $V_{CC} = V_{REF} = 4.75V$  to  $5.25V$ ,  $V_{GND} = 0$ ,  $PD = 0$ ,  $VG\_CLAMP\_MODE = 1$ ,  $f_{RF} = 5MHz$ , capacitance to GND at each of the VGA differential outputs is  $60pF$ , differential capacitance across the VGA outputs is  $10pF$ ,  $R_L = 1k\Omega$ ,  $T_A = 0^\circ C$  to  $+70^\circ C$ . Typical values are at  $V_{CC} = V_{REF} = 5V$ ,  $T_A = +25^\circ C$ , unless otherwise noted.)

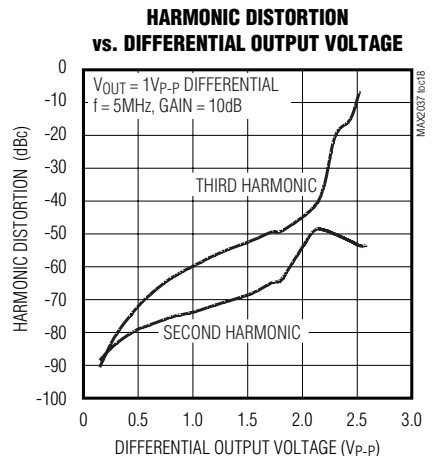
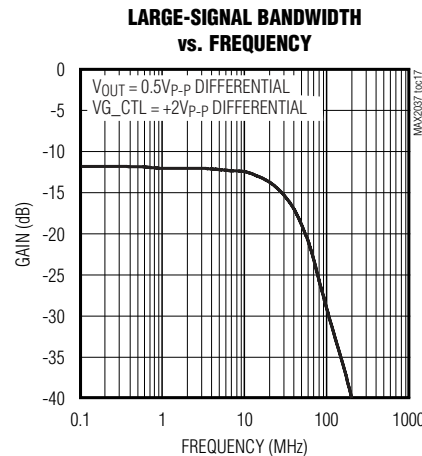
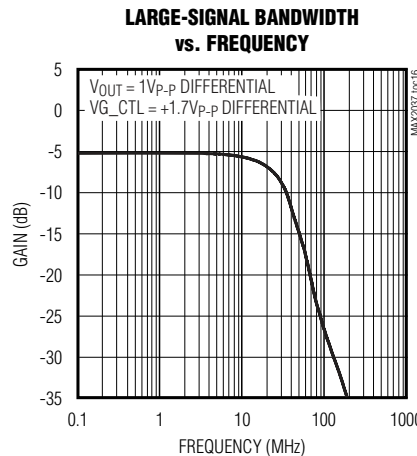
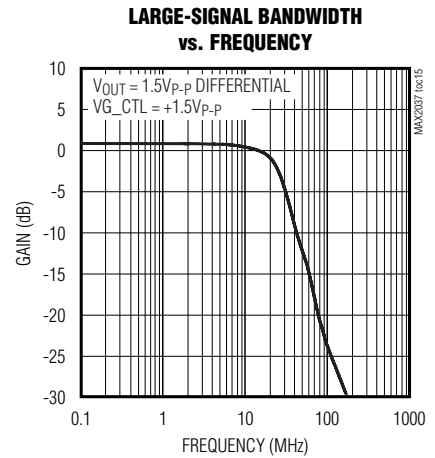
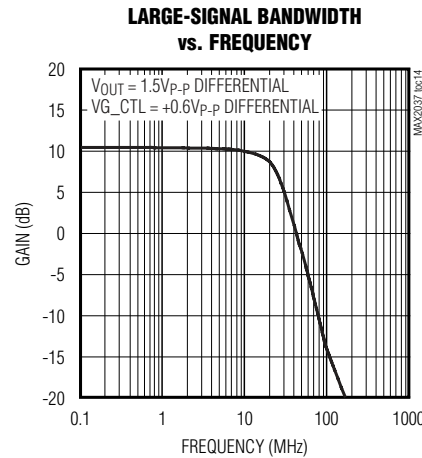
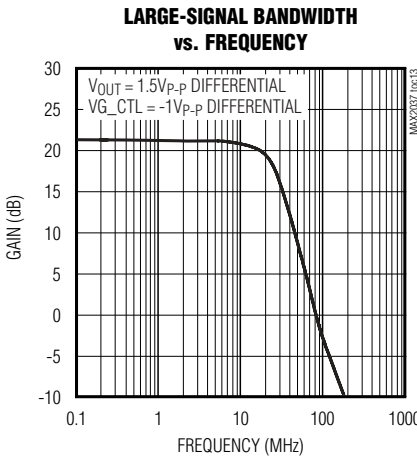
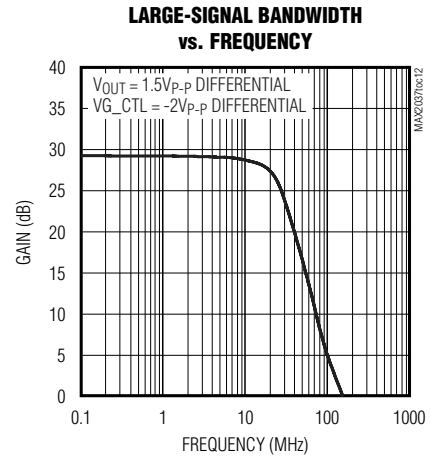
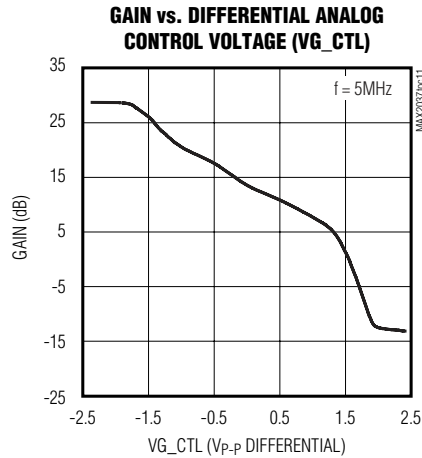
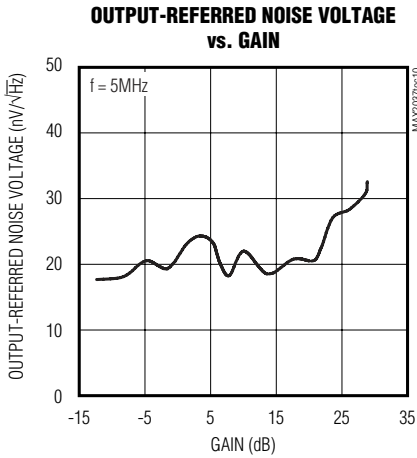

# Ultrasound Variable-Gain Amplifier

MAX2037

## Typical Operating Characteristics (continued)

(Figure 2,  $V_{CC} = V_{REF} = 4.75V$  to  $5.25V$ ,  $V_{GND} = 0$ ,  $PD = 0$ ,  $VG\_CLAMP\_MODE = 1$ ,  $f_{RF} = 5MHz$ , capacitance to GND at each of the VGA differential outputs is  $60pF$ , differential capacitance across the VGA outputs is  $10pF$ ,  $R_L = 1k\Omega$ ,  $T_A = 0^\circ C$  to  $+70^\circ C$ . Typical values are at  $V_{CC} = V_{REF} = 5V$ ,  $T_A = +25^\circ C$ , unless otherwise noted.)

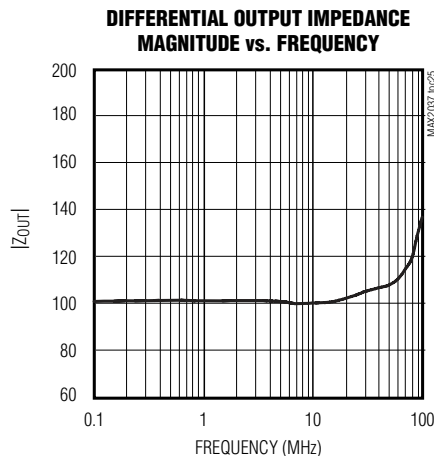
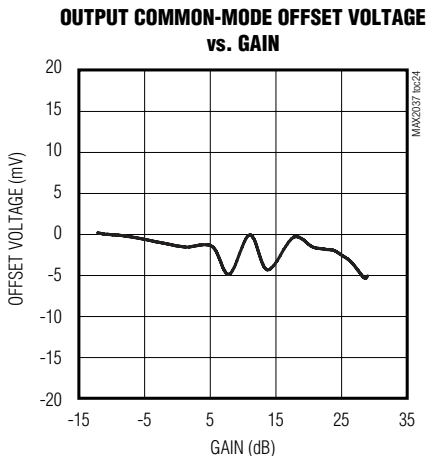
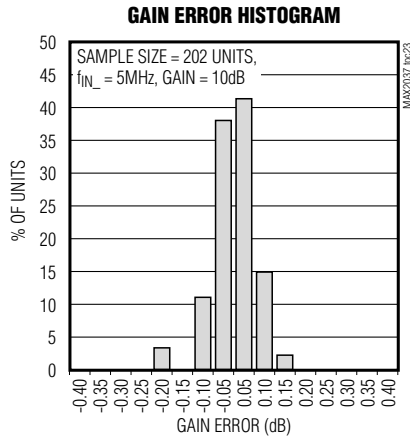
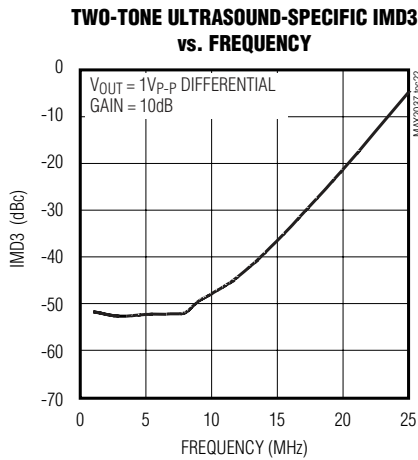
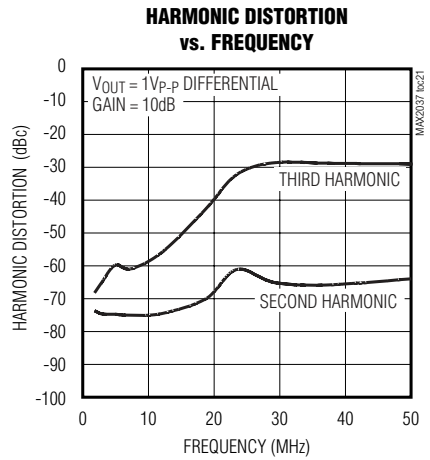
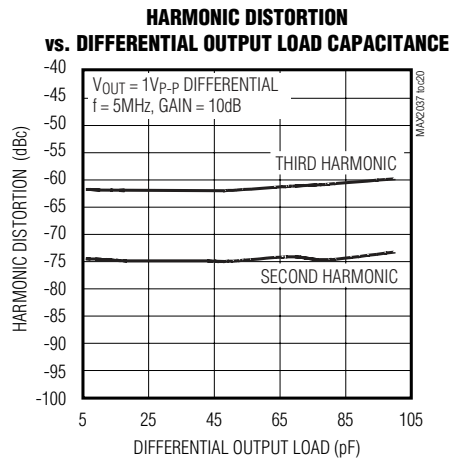
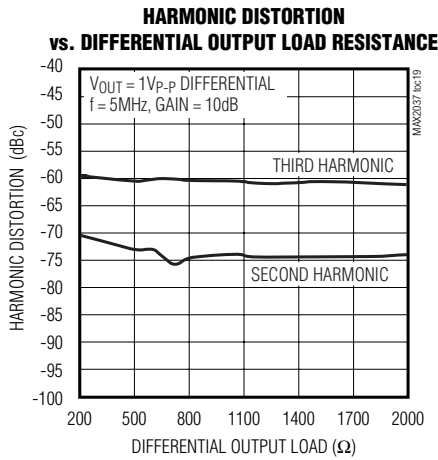

# Ultrasound Variable-Gain Amplifier

## Pin Description

PIN	NAME	FUNCTION
1, 2, 5, 6, 7, 10, 11, 12, 19, 20, 21, 24, 25, 26, 29, 30, 31, 34, 35, 36, 41, 43, 44, 45, 47, 48, 51, 55, 58, 59, 64, 65, 66, 69, 73, 76, 79, 80, 81, 83, 84, 85, 88–92, 96, 97, 98	GND	Ground
3	VGIN3-	VGA Channel 3 Inverting Differential Input
4	VGIN3+	VGA Channel 3 Noninverting Differential Input
8	VGIN4-	VGA Channel 4 Inverting Differential Input
9	VGIN4+	VGA Channel 4 Noninverting Differential Input
13	EXT_C1	External Compensation. Connect a 4.7 $\mu$ F capacitor to ground.
14	EXT_C2	External Compensation. Connect a 4.7 $\mu$ F capacitor to ground.
15	EXT_C3	External Compensation. Connect a 4.7 $\mu$ F capacitor to ground.
16, 39, 42, 46, 54, 72, 82, 87	V <sub>CC</sub>	5V Power Supply. Bypass each V <sub>CC</sub> supply to ground with 0.1 $\mu$ F capacitors as close to the pins as possible.
17	VGIN5-	VGA Channel 5 Inverting Differential Input
18	VGIN5+	VGA Channel 5 Noninverting Differential Input
22	VGIN6-	VGA Channel 6 Inverting Differential Input
23	VGIN6+	VGA Channel 6 Noninverting Differential Input
27	VGIN7-	VGA Channel 7 Inverting Differential Input
28	VGIN7+	VGA Channel 7 Noninverting Differential Input
32	VGIN8-	VGA Channel 8 Inverting Differential Input
33	VGIN8+	VGA Channel 8 Noninverting Differential Input
37, 93	VREF	5V Reference Supply. Bypass to GND with a 0.1 $\mu$ F capacitor as close to the pins as possible. Note that noise performance of the device is dependent on the noise contribution from the supply to VREF. Use a low noise supply for VREF. V <sub>CC</sub> and VREF can be connected together to share the same supply voltage if the supply for V <sub>CC</sub> exhibits low noise.
38	EXT_RES	External Resistor. Connect a 7.5k $\Omega$ resistor to ground.
40	PD	Power-Down Switch. Drive PD high to set the device in power-down mode. Drive PD low for normal operation.
49	VGOUT8+	VGA Channel 8 Noninverting Differential Output
50	VGOUT8-	VGA Channel 8 Inverting Differential Output
52	VGOUT7+	VGA Channel 7 Noninverting Differential Output
53	VGOUT7-	VGA Channel 7 Inverting Differential Output
56	VGOUT6+	VGA Channel 6 Noninverting Differential Output
57	VGOUT6-	VGA Channel 6 Inverting Differential Output
60	VGOUT5+	VGA Channel 5 Noninverting Differential Output



# Ultrasound Variable-Gain Amplifier

MAX2037

## Pin Description (continued)

PIN	NAME	FUNCTION
61	VGOUT5-	VGA Channel 5 Inverting Differential Output
62	VG_CTL-	VGA Analog Gain-Control Inverting Input
63	VG_CTL+	VGA Analog Gain-Control Noninverting Input
67	VGOUT4+	VGA Channel 4 Noninverting Differential Output
68	VGOUT4-	VGA Channel 4 Inverting Differential Output
70	VGOUT3+	VGA Channel 3 Noninverting Differential Output
71	VGOUT3-	VGA Channel 3 Inverting Differential Output
74	VGOUT2+	VGA Channel 2 Noninverting Differential Output
75	VGOUT2-	VGA Channel 2 Inverting Differential Output
77	VGOUT1+	VGA Channel 1 Noninverting Differential Output
78	VGOUT1-	VGA Channel 1 Inverting Differential Output
86	VG_CLAMP_MODE	VGA Clamp Mode Enable. Drive VG_CLAMP_MODE low to enable VGA clamping. VGA output will be clamped at typically 2.4V <sub>P-P</sub> differential. Drive VG_CLAMP_MODE high to disable VGA clamp mode.
94	VGIN1-	VGA Channel 1 Inverting Differential Input
95	VGIN1+	VGA Channel 1 Noninverting Differential Input
99	VGIN2-	VGA Channel 2 Inverting Differential Input
100	VGIN2+	VGA Channel 2 Noninverting Differential Input
—	EP	Exposed pad. Internally connected to GND. Solder the exposed pad to the ground plane using multiple vias.

## Detailed Description

The MAX2037's VGAs are optimized for high linearity, high dynamic range, and low output noise performance, making this component ideal for ultrasound-imaging applications. The VGA paths also exhibit a channel-to-channel crosstalk of -80dB at 10MHz and an absolute gain error of less than  $\pm 0.25$ dB for minimal channel-to-channel focusing error in an ultrasound system. Each VGA path includes circuitry for adjusting analog gain, an output buffer with differential output ports (VGOUT<sub>+</sub>, VGOUT<sub>-</sub>) for driving ADCs, and differential input ports (VGIN<sub>+</sub>, VGIN<sub>-</sub>) that are ideal for directly interfacing to the MAX2034 quad LNA. See the *Functional Diagram* for details.

The VGA has an adjustable gain range from -12.5dB to +29.5dB, achieving a total dynamic range of typically 42dB. The VGA gain can be adjusted with the differential gain-control input VG\_CTL<sub>+</sub> and VG\_CTL<sub>-</sub>. Set the differential gain-control input voltage at -2V for maximum gain and +2V for minimum gain. The differential analog control common-mode voltage is typically 3.0V.

## VGA Clamp

A clamp is provided to limit the VGA output signals to avoid overdriving the ADC or to prevent ADC saturation. Set VG\_CLAMP\_MODE low to clamp the VGA differential outputs at 2.4V<sub>P-P</sub>. Set the VG\_CLAMP\_MODE high to disable the clamp.

## Power Down

The device can also be powered down with PD. Set PD to logic-high for power-down mode. In power-down mode, the device draws a total supply current of 27mA. Set PD to a logic-low for normal operation.

## Overload Recovery

The device is also optimized for quick overload recovery for operation under the large input signal conditions that are typically found in ultrasound input buffer imaging applications. See the *Typical Operating Characteristics* for an illustration of the rapid recovery time from a transmit-related overload.

# Ultrasound Variable-Gain Amplifier

## Applications Information

### External Compensation

External compensation is required for bypassing internal biasing circuitry. Connect, as close as possible, individual 4.7 $\mu$ F capacitors from each pin EXT\_C1, EXT\_C2, and EXT\_C3 (pin 13, 14, 15) to ground.

### External Bias Resistor

An external resistor at EXT\_RES is required to set the bias for the internal biasing circuitry. Connect, as close as possible, a 7.5k $\Omega$  resistor from EXT\_RES (pin 38) to ground.

### Analog Input and Output Coupling

In typical applications, the MAX2037 is being driven from a low-noise amplifier (such as the MAX2034) and is typically driving a discrete differential anti-alias filter into an ADC (such as the MAX1436 octal ADC). The differential input impedance of the MAX2037 is typically 200 $\Omega$ . The differential outputs are capable of driving a differential load resistance of 1000 $\Omega$ . The output impedance is 100 $\Omega$  differential. The differential outputs have a common-mode bias of approximately 3.0V. AC-couple these differential outputs if the next stage has a different common-mode input range.

### Ultrasound-Specific IMD3 Specification

Unlike typical communications specs, the two input tones are not equal in magnitude for the ultrasound-specific IMD3 two-tone specification. In this measurement,  $f_1$  represents reflections from tissue and  $f_2$  represents reflections from blood. The latter reflections are typically 25dB lower in magnitude, and hence the measurement is defined with one input tone 25dB lower than the other. The IMD3 product of interest ( $f_1 - (f_2 - f_1)$ ) presents itself as an undesired Doppler error signal in ultrasound applications. See Figure 1.

## Board Layout

The pin configuration of the MAX2037 is optimized to facilitate a very compact physical layout of the device and its associated discrete components. A typical application for this device might incorporate several devices in close proximity to handle multiple channels of signal processing.

The exposed pad (EP) of the MAX2037's TQFP-EP package provides a low thermal-resistance path to the die. It is important that the PCB on which the MAX2037 is mounted be designed to conduct heat from the EP. In addition, provide the EP with a low-inductance path to electrical ground. The EP **MUST** be soldered to a ground plane on the PCB, either directly or through an array of plated via holes.

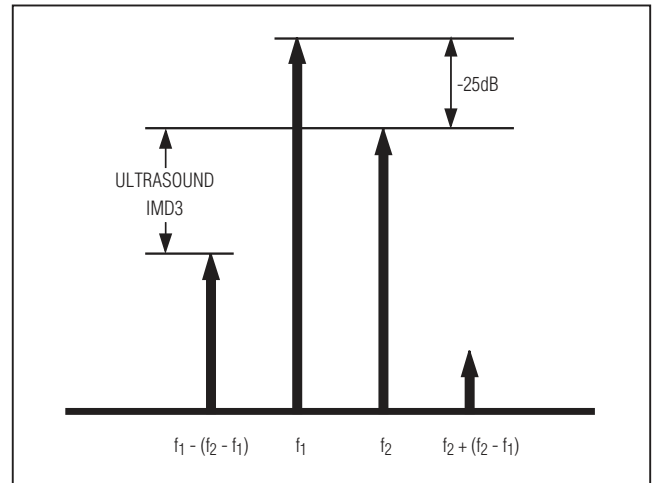

Figure 1. Ultrasound IMD3 Measurement Technique

# Ultrasound Variable-Gain Amplifier

MAX2037

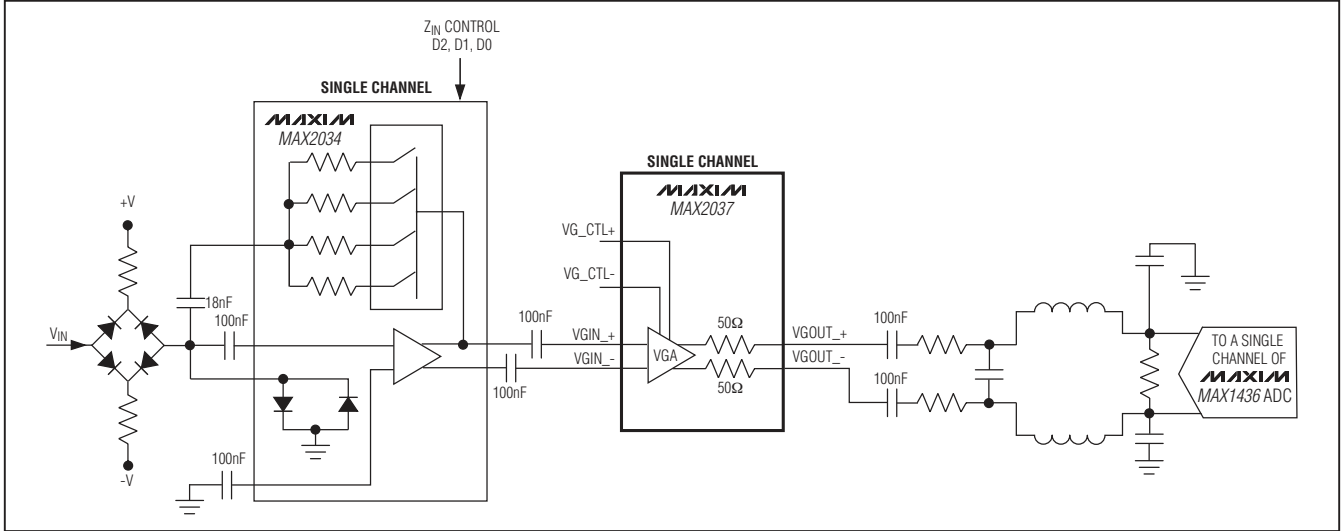
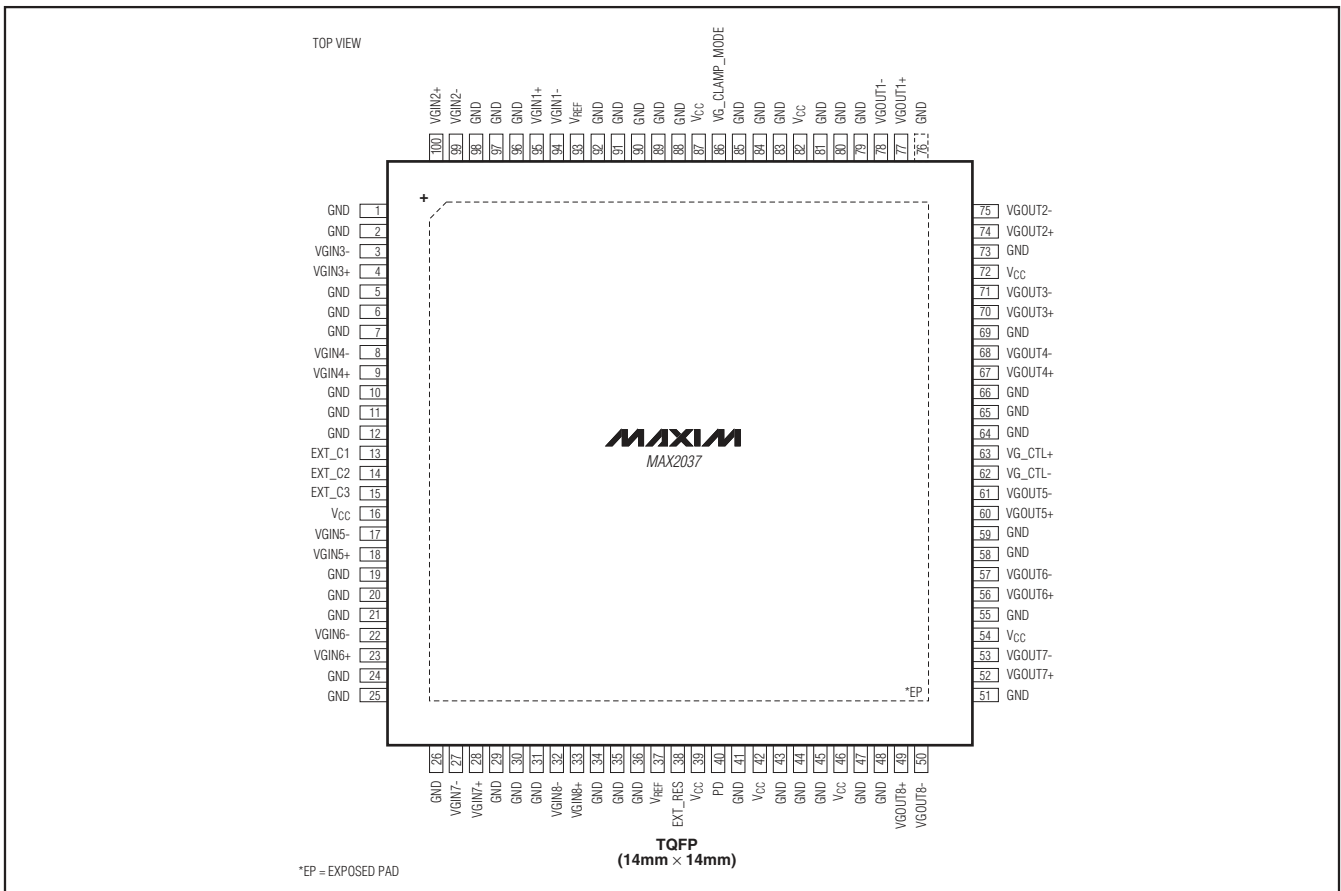

Figure 2. Typical Per-Channel Ultrasound-Imaging Application

## Pin Configuration



# **Ultrasound Variable-Gain Amplifier**

## **Chip Information**

PROCESS: Silicon Complementary Bipolar

## **Package Information**

For the latest package outline information and land patterns, go to [www.maxim-ic.com/packages](http://www.maxim-ic.com/packages).

<b>PACKAGE TYPE</b>	<b>PACKAGE CODE</b>	<b>DOCUMENT NO.</b>
100 TQFP-EP	C100E+3	<a href="#">21-0116</a>

# Ultrasound Variable-Gain Amplifier

## Revision History

REVISION NUMBER	REVISION DATE	DESCRIPTION	PAGES CHANGED
0	10/06	Initial release	—
1	2/09	Updated various sections	1-7, 9, 12

MAX2037

Maxim cannot assume responsibility for use of any circuitry other than circuitry entirely embodied in a Maxim product. No circuit patent licenses are implied. Maxim reserves the right to change the circuitry and specifications without notice at any time.

Maxim Integrated Products, 120 San Gabriel Drive, Sunnyvale, CA 94086 408-737-7600 \_\_\_\_\_ 13