

Si/SiC Hybrid Module – EliteSiC, 3-channel, 1200 V IGBT + SiC Boost, 80 A IGBT and 20 A SiC Diode, Q1 Package

NXH240B120H3Q1PG, NXH240B120H3Q1PG-R, NXH240B120H3Q1SG

The NXH240B120H3Q1PG is a case power module containing a three channel BOOST stage. The integrated field stop trench IGBTs and SiC Diodes provide lower conduction losses and switching losses, enabling designers to achieve high efficiency and superior reliability.

Features

- 1200 V Ultra Field Stop IGBTs
- Low Reverse Recovery and Fast Switching SiC Diodes
- Low Inductive Layout
- Press-fit Pins
- Thermistor

Typical Applications

- Solar Inverters
- ESS

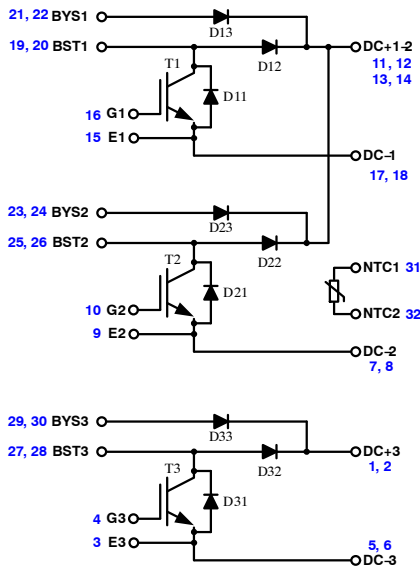
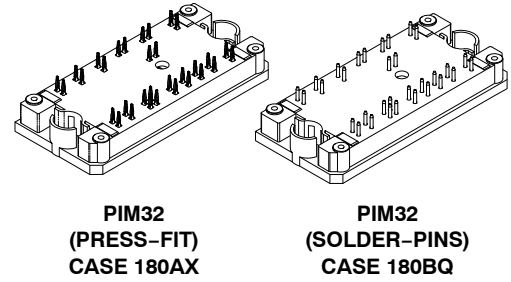
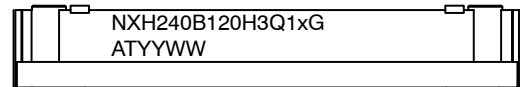

Figure 1. Schematic Diagram



MARKING DIAGRAM



NXH240B120H3Q1xG = Specific Device Code

x = P or S

G = Pb-Free Package

AT = Assembly & Test Site Code

YYWW = Year and Work Week Code

PIN ASSIGNMENTS

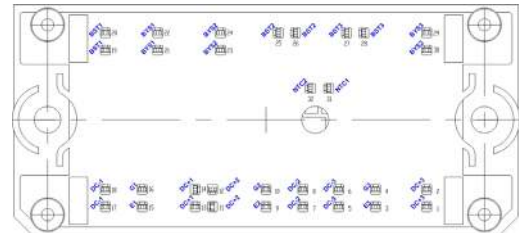

ORDERING INFORMATION

See detailed ordering and shipping information in the dimensions section on page 12 of this data sheet.

NXH240B120H3Q1PG, NXH240B120H3Q1PG-R, NXH240B120H3Q1SG

Table 1. MAXIMUM RATINGS (Note 1)

Rating	Symbol	Value	Unit
IGBT (T1, T2, T3)			
Collector-Emitter Voltage	V_{CES}	1200	V
Gate-Emitter Voltage	V_{GE}	± 20	V
Continuous Collector Current @ $T_h = 80^\circ\text{C}$ ($T_J = 175^\circ\text{C}$)	I_C	68	A
Pulsed Collector Current ($T_J = 175^\circ\text{C}$)	I_{Cpulse}	204	A
Maximum Power Dissipation ($T_J = 175^\circ\text{C}$)	P_{tot}	158	W
Minimum Operating Junction Temperature	T_{JMIN}	-40	$^\circ\text{C}$
Maximum Operating Junction Temperature	T_{JMAX}	150	$^\circ\text{C}$

PROTECTION DIODE (D11, D21, D31)

Peak Repetitive Reverse Voltage	V_{RRM}	1200	V
Continuous Forward Current @ $T_h = 80^\circ\text{C}$ ($T_J = 150^\circ\text{C}$)	I_F	30	A
Repetitive Peak Forward Current ($T_J = 150^\circ\text{C}$)	I_{FRM}	120	A
Maximum Power Dissipation ($T_J = 150^\circ\text{C}$)	P_{tot}	44	W
Minimum Operating Junction Temperature	T_{JMIN}	-40	$^\circ\text{C}$
Maximum Operating Junction Temperature	T_{JMAX}	150	$^\circ\text{C}$

SILICON CARBIDE BOOST DIODE (D12, D22, D32)

Peak Repetitive Reverse Voltage	V_{RRM}	1200	V
Continuous Forward Current @ $T_h = 80^\circ\text{C}$ ($T_J = 175^\circ\text{C}$)	I_F	25	A
Repetitive Peak Forward Current ($T_J = 175^\circ\text{C}$)	I_{FRM}	75	A
Maximum Power Dissipation ($T_J = 175^\circ\text{C}$)	P_{tot}	73	W
Minimum Operating Junction Temperature	T_{JMIN}	-40	$^\circ\text{C}$
Maximum Operating Junction Temperature	T_{JMAX}	175	$^\circ\text{C}$

BYPASS DIODE (D13, D23, D33)

Peak Repetitive Reverse Voltage	V_{RRM}	1200	V
Continuous Forward Current @ $T_h = 80^\circ\text{C}$ ($T_J = 150^\circ\text{C}$)	I_F	42	A
Repetitive Peak Forward Current ($T_J = 150^\circ\text{C}$)	I_{FRM}	126	A
Maximum Power Dissipation ($T_J = 150^\circ\text{C}$)	P_{tot}	50	W
Minimum Operating Junction Temperature	T_{JMIN}	-40	$^\circ\text{C}$
Maximum Operating Junction Temperature	T_{JMAX}	150	$^\circ\text{C}$

THERMAL PROPERTIES

Storage Temperature range	T_{stg}	-40 to 150	$^\circ\text{C}$
---------------------------	-----------	------------	------------------

INSULATION PROPERTIES

Isolation test voltage, $t = 1$ sec, 60 Hz	V_{is}	3000	V_{RMS}
Creepage distance		12.7	mm

Stresses exceeding those listed in the Maximum Ratings table may damage the device. If any of these limits are exceeded, device functionality should not be assumed, damage may occur and reliability may be affected.

1. Refer to ELECTRICAL CHARACTERISTICS, RECOMMENDED OPERATING RANGES and/or APPLICATION INFORMATION for Safe Operating parameters.

Table 2. RECOMMENDED OPERATING RANGES

Rating	Symbol	Min	Max	Unit
Module Operating Junction Temperature	T_J	-40	150	$^\circ\text{C}$

Functional operation above the stresses listed in the Recommended Operating Ranges is not implied. Extended exposure to stresses beyond the Recommended Operating Ranges limits may affect device reliability.

NXH240B120H3Q1PG, NXH240B120H3Q1PG-R, NXH240B120H3Q1SG

Table 3. ELECTRICAL CHARACTERISTICS $T_J = 25^\circ\text{C}$ unless otherwise noted

Parameter	Test Conditions	Symbol	Min	Typ	Max	Unit
IGBT (T1, T2, T3)						
Collector-Emitter Cutoff Current	$V_{GE} = 0\text{ V}, V_{CE} = 1200\text{ V}$	I_{CES}	-	-	400	μA
Collector-Emitter Saturation Voltage	$V_{GE} = 15\text{ V}, I_C = 80\text{ A}, T_J = 25^\circ\text{C}$	$V_{CE(sat)}$	-	1.65	2	V
	$V_{GE} = 15\text{ V}, I_C = 80\text{ A}, T_J = 150^\circ\text{C}$		-	1.85	-	
Gate-Emitter Threshold Voltage	$V_{GE} = V_{CE}, I_C = 1.0\text{ mA}$	$V_{GE(TH)}$	4.50	5.87	6.50	V
Gate Leakage Current	$V_{GE} = 20\text{ V}, V_{CE} = 0\text{ V}$	I_{GES}	-	-	800	nA
Turn-on Delay Time	$T_J = 25^\circ\text{C}$ $V_{CE} = 800\text{ V}, I_C = 50\text{ A}$ $V_{GE} = +15\text{ V}, -9\text{ V}, R_G = 4.3\ \Omega$	$t_{d(on)}$	-	13	-	ns
Rise Time		t_r	-	22	-	
Turn-off Delay Time		$t_{d(off)}$	-	262	-	
Fall Time		t_f	-	13	-	
Turn-on Switching Loss per Pulse		E_{on}	-	1258	-	
Turn off Switching Loss per Pulse	E_{off}	-	1277	-		
Turn-on Delay Time	$T_J = 125^\circ\text{C}$ $V_{CE} = 800\text{ V}, I_C = 50\text{ A}$ $V_{GE} = +15\text{ V}, -9\text{ V}, R_G = 4.3\ \Omega$	$t_{d(on)}$	-	32	-	ns
Rise Time		t_r	-	22	-	
Turn-off Delay Time		$t_{d(off)}$	-	315	-	
Fall Time		t_f	-	22	-	
Turn-on Switching Loss per Pulse		E_{on}	-	1306	-	
Turn off Switching Loss per Pulse	E_{off}	-	2221	-		
Input Capacitance	$V_{CE} = 20\text{ V}, V_{GE} = 0\text{ V}, f = 10\text{ kHz}$	C_{ies}	-	18151	-	pF
Output Capacitance		C_{oes}	-	345	-	
Reverse Transfer Capacitance		C_{res}	-	294	-	
Total Gate Charge	$V_{CE} = 600\text{ V}, I_C = 25\text{ A}, V_{GE} = \pm 15\text{ V}$	Q_g	-	817	-	nC
Thermal Resistance – chip-to-heatsink	Thermal grease, Thickness = 2 Mil $\pm 2\%$, $\lambda = 0.63\text{ W/mK}$	R_{thJH}	-	0.60	-	$^\circ\text{C/W}$
Thermal Resistance – chip-to-case		R_{thJC}	-	0.29	-	$^\circ\text{C/W}$
PROTECTION DIODE (D11, D21, D31)						
Diode Forward Voltage	$I_F = 30\text{ A}, T_J = 25^\circ\text{C}$	V_F	-	1.09	1.3	V
	$I_F = 30\text{ A}, T_J = 150^\circ\text{C}$		-	0.99	-	
Thermal Resistance – chip-to-heatsink	Thermal grease, Thickness = 2 Mil $\pm 2\%$, $\lambda = 0.63\text{ W/mK}$	R_{thJH}	-	1.60	-	$^\circ\text{C/W}$
Thermal Resistance – chip-to-case		R_{thJC}	-	0.98	-	$^\circ\text{C/W}$
SILICON CARBIDE BOOST DIODE (D12, D22, D32)						
Diode Forward Voltage	$I_F = 20\text{ A}, T_J = 25^\circ\text{C}$	V_F	-	1.48	1.75	V
	$I_F = 20\text{ A}, T_J = 150^\circ\text{C}$		-	1.99	-	
Reverse Recovery Time	$T_J = 25^\circ\text{C}$ $V_{CE} = 800\text{ V}, I_C = 50\text{ A}$ $V_{GE} = +15\text{ V}, -9\text{ V}, R_G = 4.3\ \Omega$	t_{rr}	-	21	-	ns
Reverse Recovery Charge		Q_{rr}	-	84	-	μC
Peak Reverse Recovery Current		I_{RRM}	-	7	-	A
Peak Rate of Fall of Recovery Current		di/dt	-	1750	-	$\text{A}/\mu\text{s}$
Reverse Recovery Energy		E_{rr}	-	65	-	μJ
Reverse Recovery Time	$T_J = 125^\circ\text{C}$ $V_{CE} = 800\text{ V}, I_C = 50\text{ A}$ $V_{GE} = +15\text{ V}, -9\text{ V}, R_G = 4.3\ \Omega$	t_{rr}	-	22	-	ns
Reverse Recovery Charge		Q_{rr}	-	89	-	μC
Peak Reverse Recovery Current		I_{RRM}	-	8	-	A
Peak Rate of Fall of Recovery Current		di/dt	-	1800	-	$\text{A}/\mu\text{s}$
Reverse Recovery Energy		E_{rr}	-	99	-	μJ

NXH240B120H3Q1PG, NXH240B120H3Q1PG-R, NXH240B120H3Q1SG

Table 3. ELECTRICAL CHARACTERISTICS $T_J = 25^\circ\text{C}$ unless otherwise noted

Parameter	Test Conditions	Symbol	Min	Typ	Max	Unit
-----------	-----------------	--------	-----	-----	-----	------

SILICON CARBIDE BOOST DIODE (D12, D22, D32)

Thermal Resistance – chip-to-heatsink	Thermal grease, Thickness = 2 Mil $\pm 2\%$, $\lambda = 0.63$ W/mK	R_{thJH}	–	1.30	–	$^\circ\text{C/W}$
Thermal Resistance – chip-to-case		R_{thJC}	–	0.85	–	$^\circ\text{C/W}$

BYPASS DIODE (D13, D23, D33)

Diode Forward Voltage	I _F = 50 A, T _J = 25 $^\circ\text{C}$	V_F	–	1.095	1.3	V
	I _F = 50 A, T _J = 150 $^\circ\text{C}$		–	1.004	–	
Thermal Resistance – chip-to-heatsink	Thermal grease, Thickness = 2 Mil $\pm 2\%$, $\lambda = 0.63$ W/mK	R_{thJH}	–	1.40	–	$^\circ\text{C/W}$
Thermal Resistance – chip-to-case		R_{thJC}	–	0.85	–	$^\circ\text{C/W}$

THERMISTOR CHARACTERISTICS

Nominal resistance	T = 25 $^\circ\text{C}$	R_{25}	–	5	–	k Ω
Nominal resistance	T = 100 $^\circ\text{C}$	R_{100}	–	493.3	–	Ω
Deviation of R25		$\Delta R/R$	–5	–	5	%
Power dissipation		P_D	–	20	–	mW
Power dissipation constant			–	1.4	–	mW/K
B-value	B(25/50), tolerance $\pm 2\%$		–	3375	–	K

Product parametric performance is indicated in the Electrical Characteristics for the listed test conditions, unless otherwise noted. Product performance may not be indicated by the Electrical Characteristics if operated under different conditions.

NXH240B120H3Q1PG, NXH240B120H3Q1PG-R, NXH240B120H3Q1SG

TYPICAL CHARACTERISTICS – IGBT (T1, T2, T3) and Silicon Carbide Schottky Diode (D12, D22, D32)

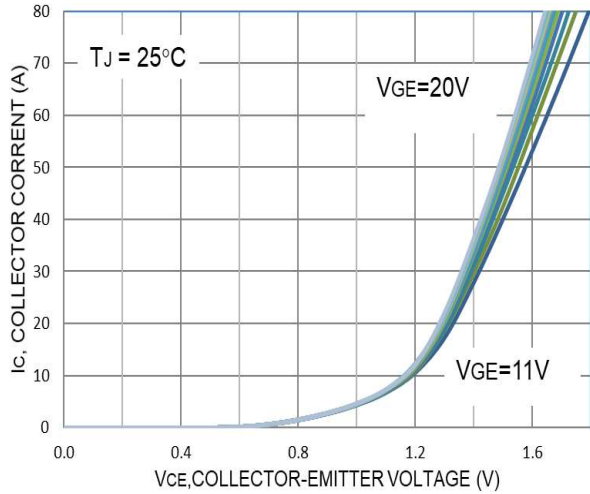

Figure 2. Typical Output Characteristics

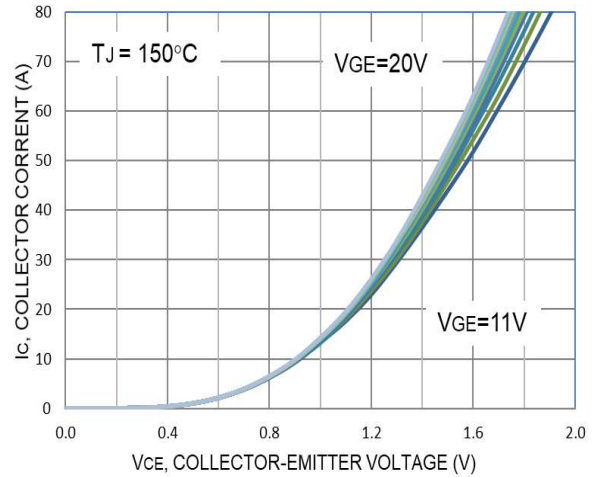

Figure 3. Typical Output Characteristics

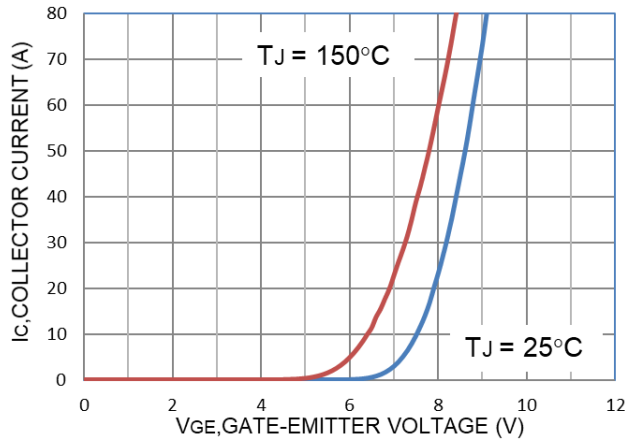

Figure 4. Typical Transfer Characteristics

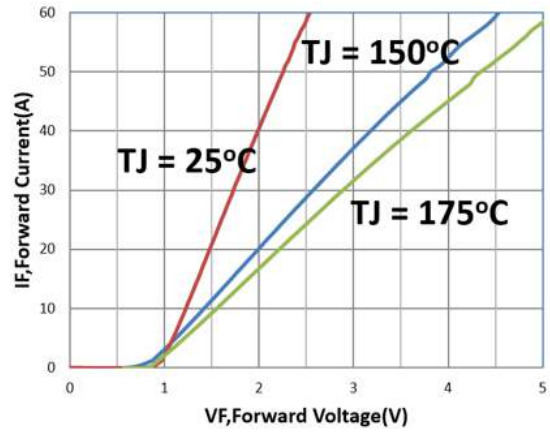

Figure 5. Diode Forward Characteristics

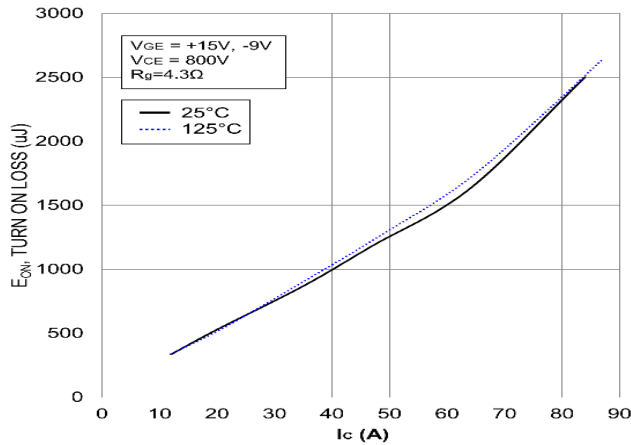

Figure 6. Typical Turn ON Loss vs. I_c

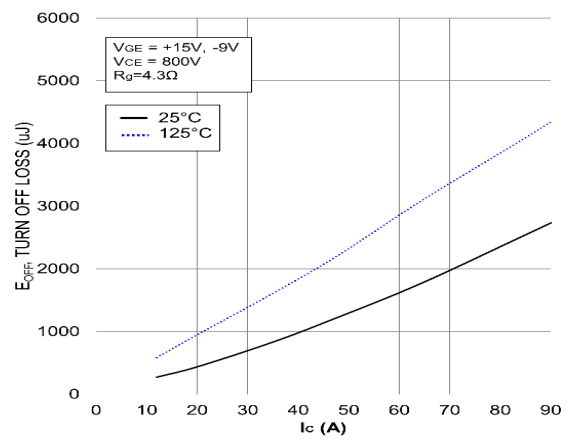

Figure 7. Typical Turn OFF Loss vs. I_c

NXH240B120H3Q1PG, NXH240B120H3Q1PG-R, NXH240B120H3Q1SG

TYPICAL CHARACTERISTICS – IGBT (T1, T2, T3) and Silicon Carbide Schottky Diode (D12, D22, D32)

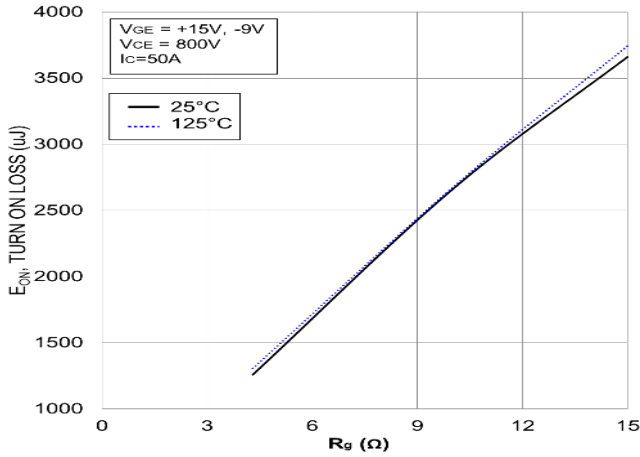

Figure 8. Typical Turn ON Loss vs. R_G

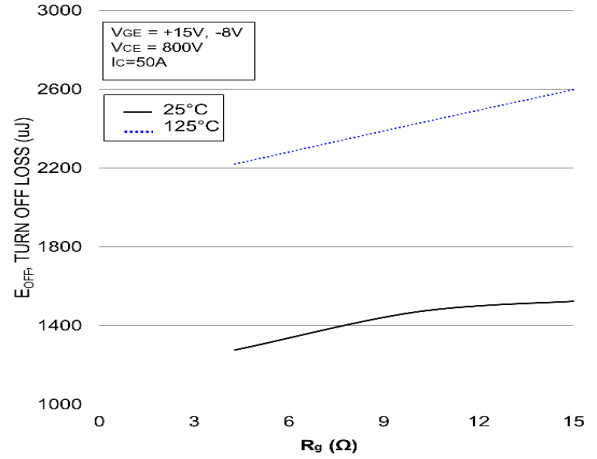

Figure 9. Typical Turn OFF Loss vs. R_G

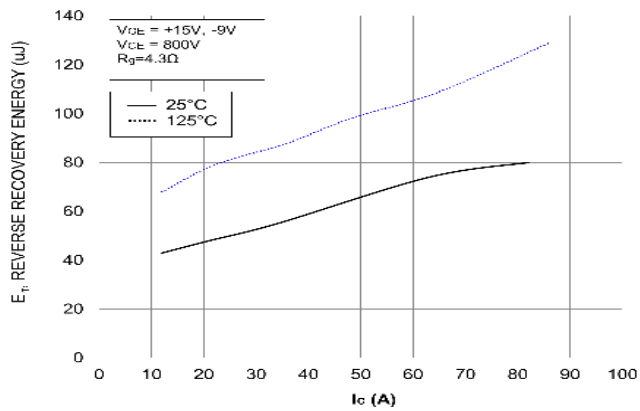

Figure 10. Typical Reverse Recovery Time vs. I_C

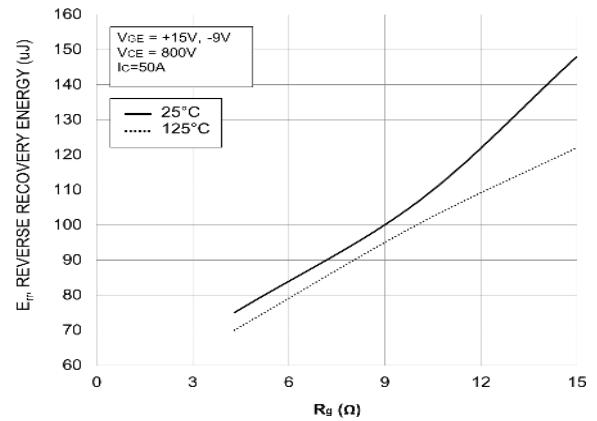

Figure 11. Typical Reverse Recovery Time vs. R_G

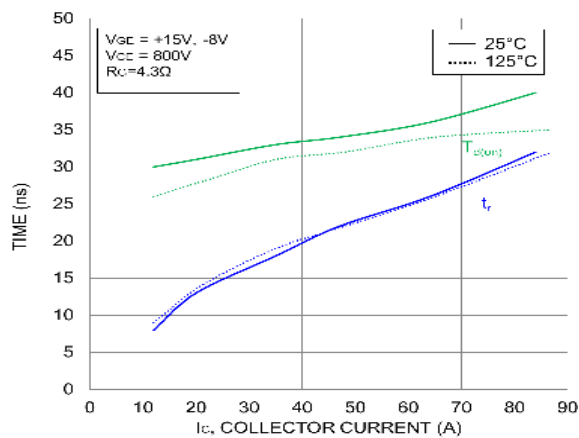

Figure 12. Typical Turn-On Switching Time vs. I_C

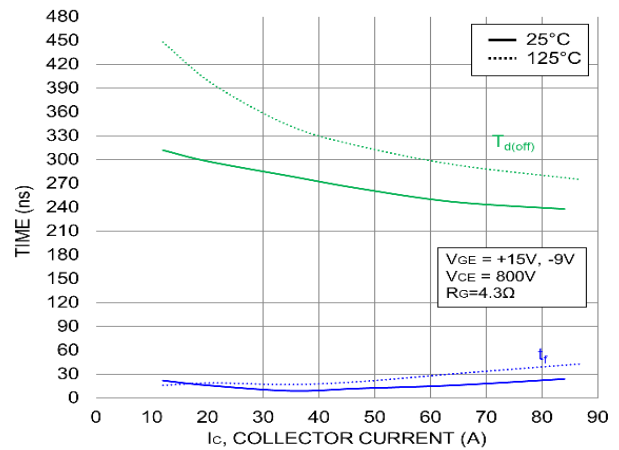

Figure 13. Typical Turn-Off Switching Time vs. I_C

NXH240B120H3Q1PG, NXH240B120H3Q1PG-R, NXH240B120H3Q1SG

TYPICAL CHARACTERISTICS – IGBT (T1, T2, T3) and Silicon Carbide Schottky Diode (D12, D22, D32)

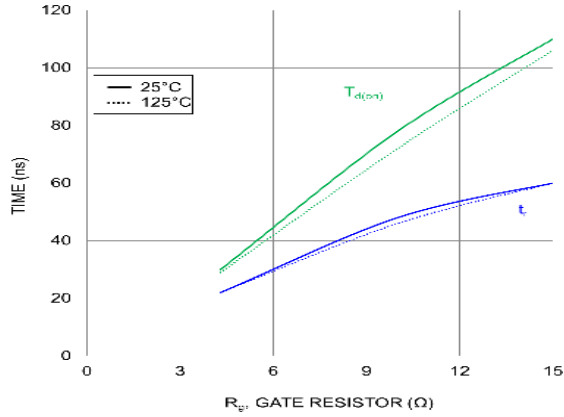

Figure 14. Typical Turn-On Switching Time vs. R_G

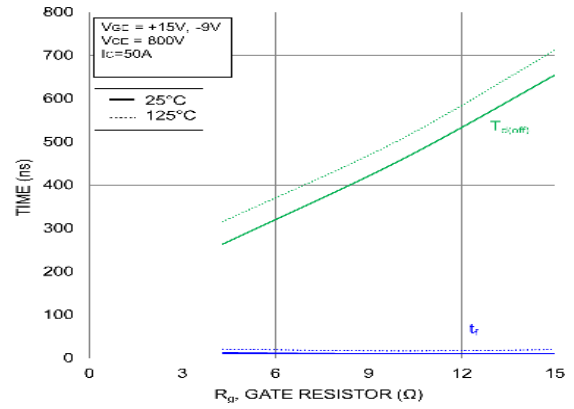

Figure 15. Typical Turn-Off Switching Time vs. R_G

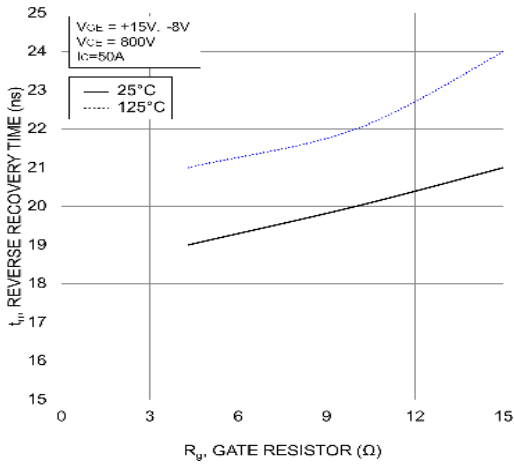

Figure 16. Typical Reverse Recovery Time vs. R_G

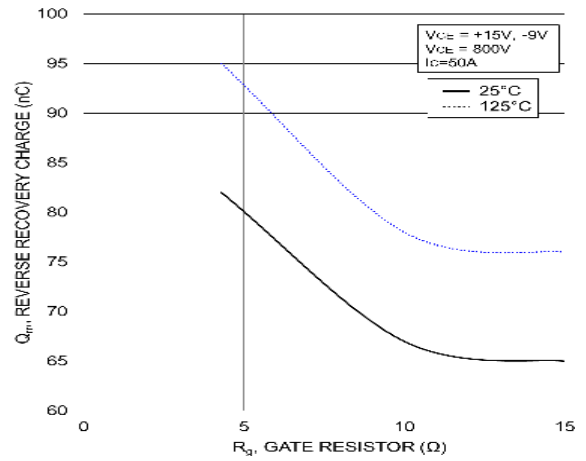

Figure 17. Typical Reverse Recovery Charge vs. R_G

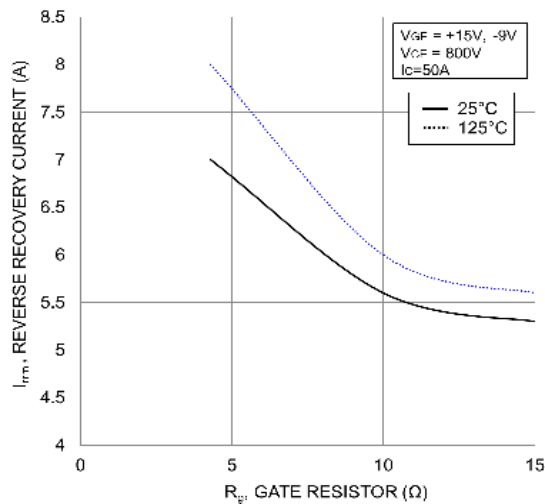

Figure 18. Typical Reverse Recovery Peak Current vs. R_G

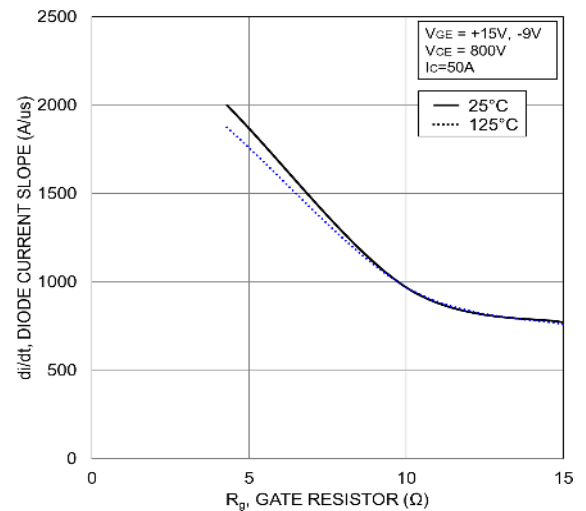

Figure 19. Typical di/dt vs. R_G

NXH240B120H3Q1PG, NXH240B120H3Q1PG-R, NXH240B120H3Q1SG

TYPICAL CHARACTERISTICS – IGBT (T1, T2, T3) and Silicon Carbide Schottky Diode (D12, D22, D32)

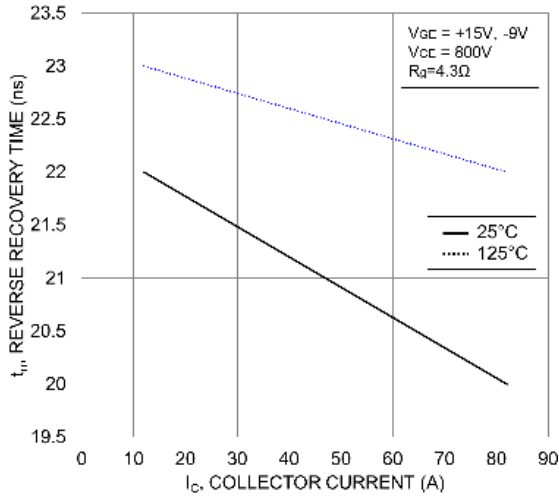

Figure 20. Typical Reverse Recovery Time vs. I_C

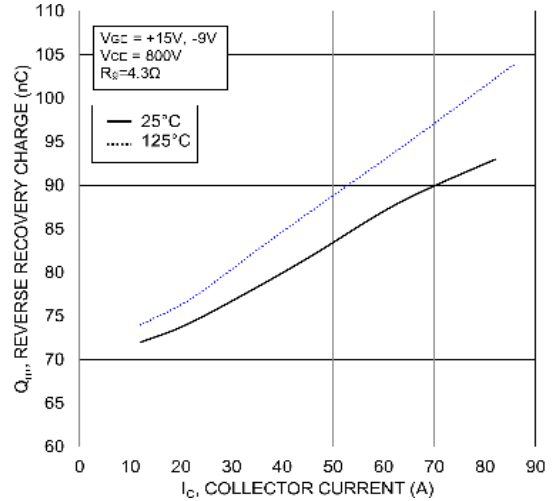

Figure 21. Typical Reverse Recovery Charge vs. I_C

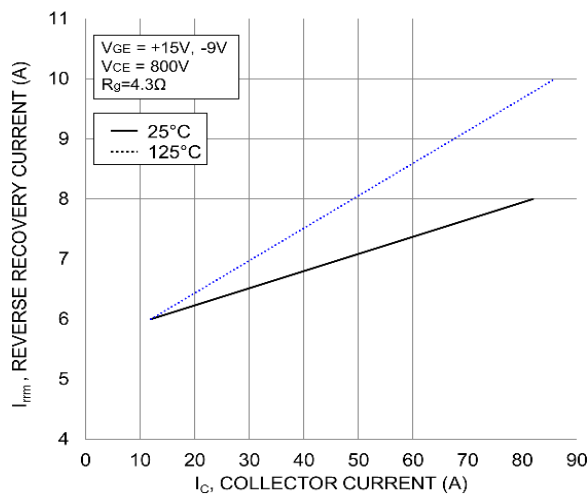

Figure 22. Typical Reverse Recovery Current vs. I_C

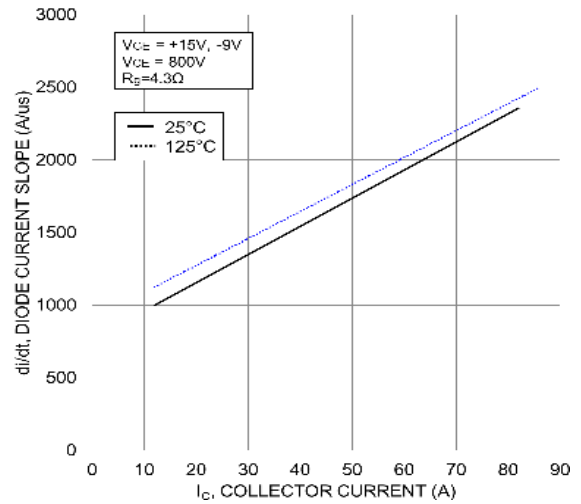

Figure 23. Typical di/dt Current Slope vs. I_C

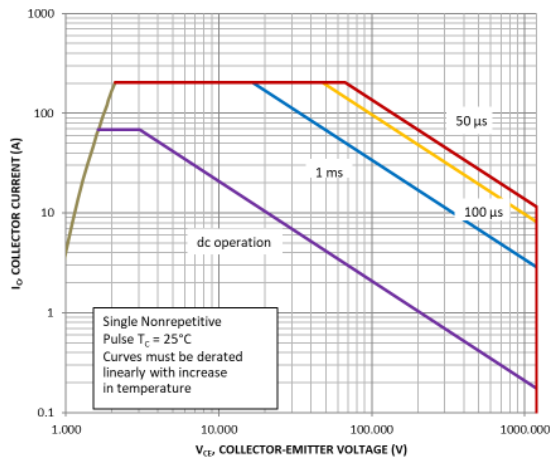

Figure 24. FBSOA

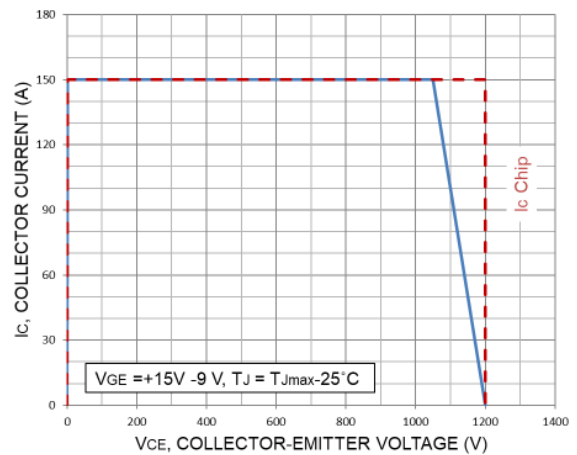

Figure 25. RBSOA

NXH240B120H3Q1PG, NXH240B120H3Q1PG-R, NXH240B120H3Q1SG

TYPICAL CHARACTERISTICS – IGBT (T1, T2, T3) and Silicon Carbide Schottky Diode (D12, D22, D32)

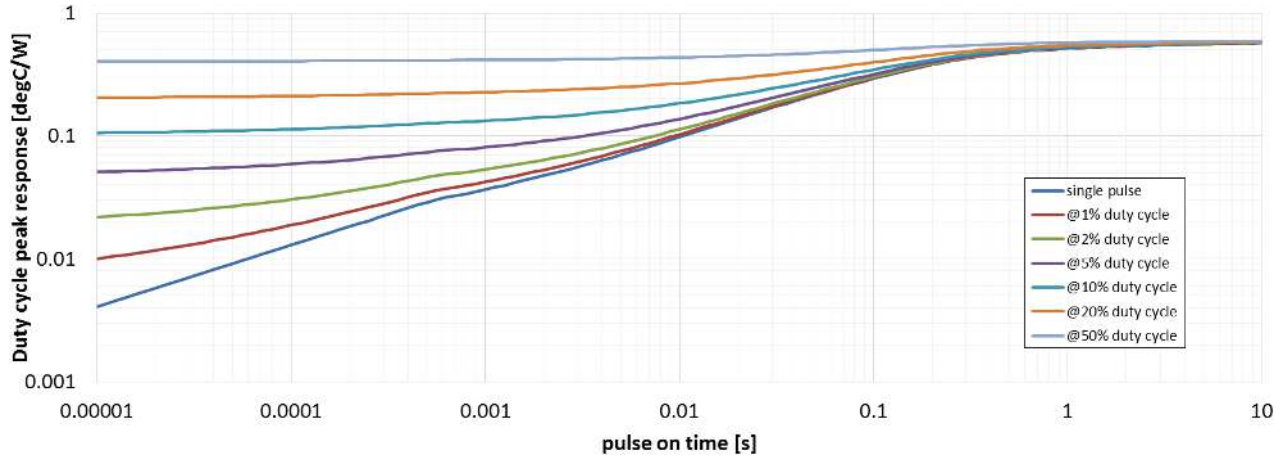

Figure 26. Transient Thermal Impedance (T1, T2, T3)

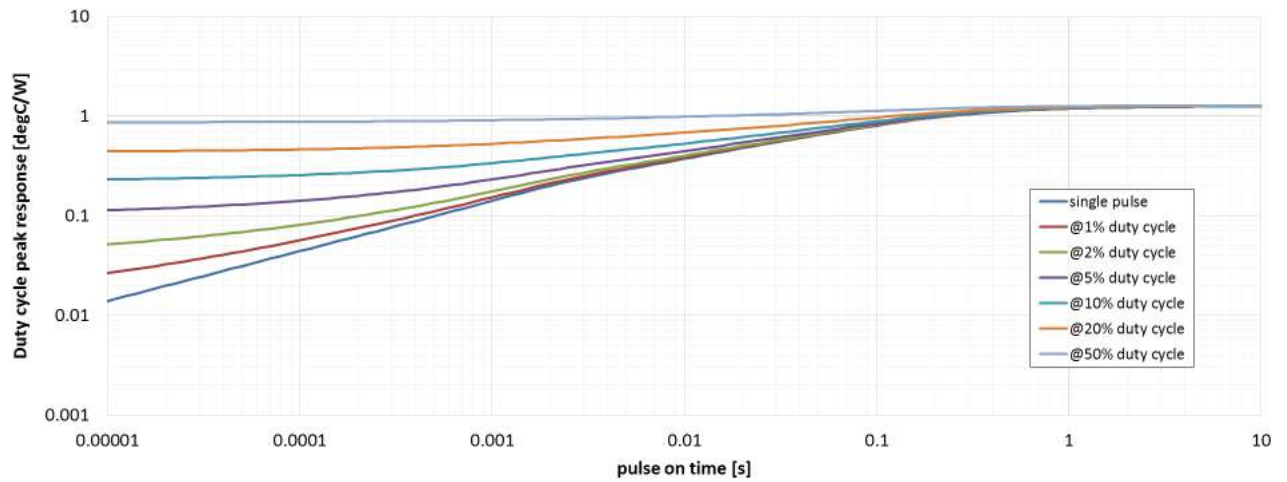

Figure 27. Transient Thermal Impedance (D12, D22, D32)

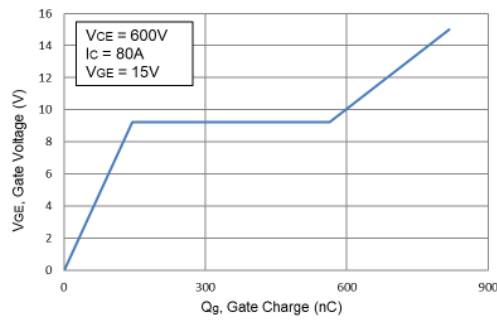

Figure 28. Gate Voltage vs. Gate Charge

TYPICAL CHARACTERISTICS – Diode (D13, D23, D33)

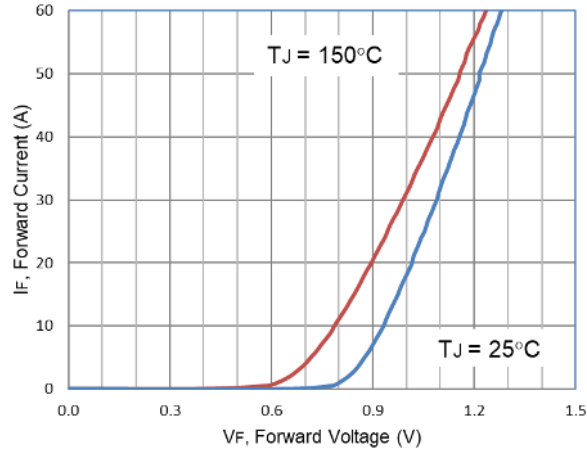

Figure 29. Diode Forward Characteristics

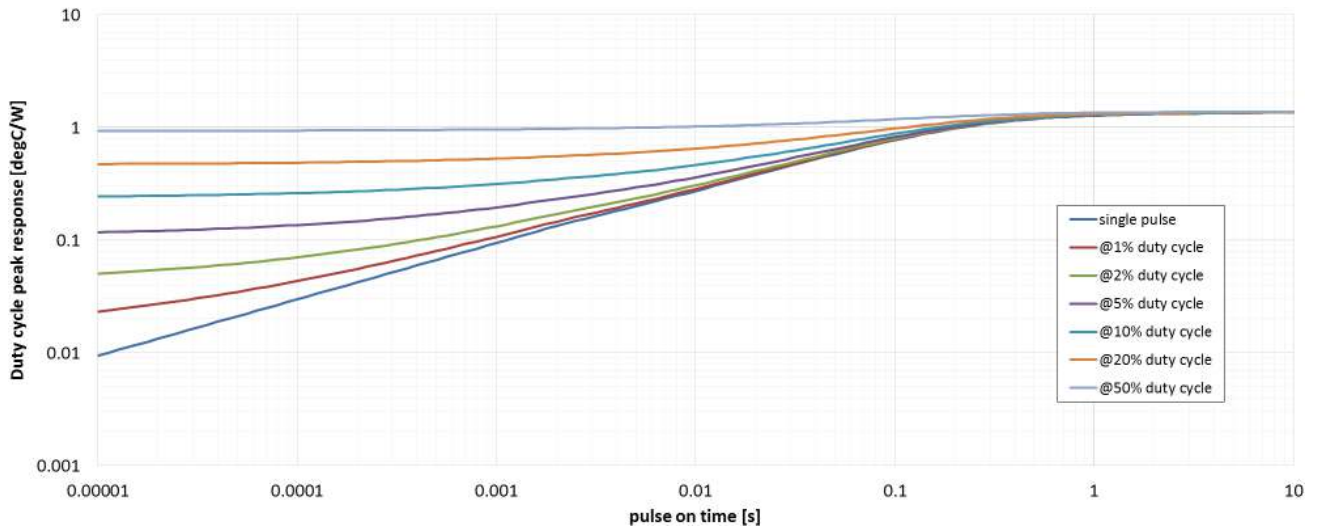

Figure 30. Transient Thermal Impedance

TYPICAL CHARACTERISTICS – Diode (D11, D21, D31)

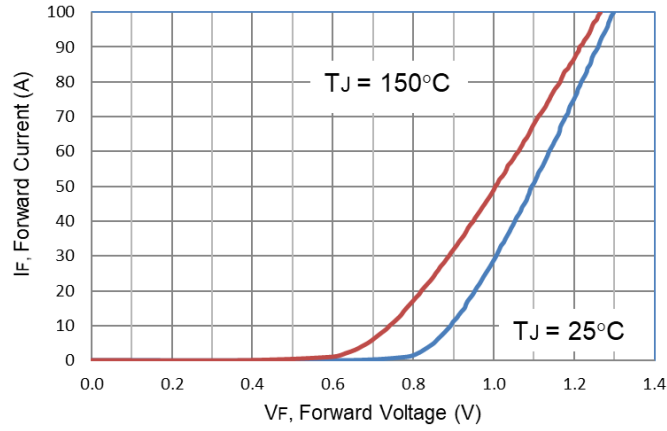

Figure 31. Diode Forward Characteristics

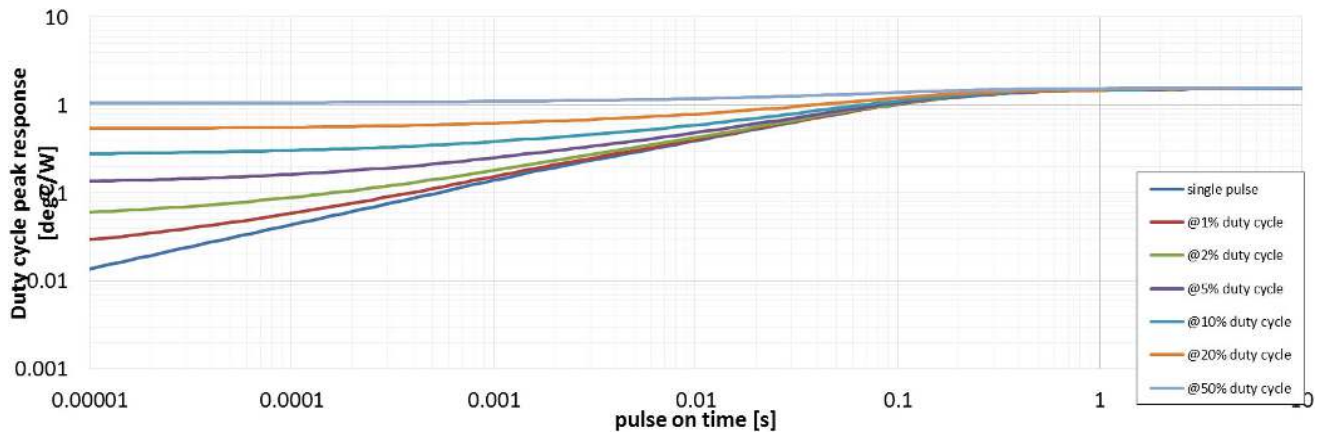

Figure 32. Transient Thermal Impedance

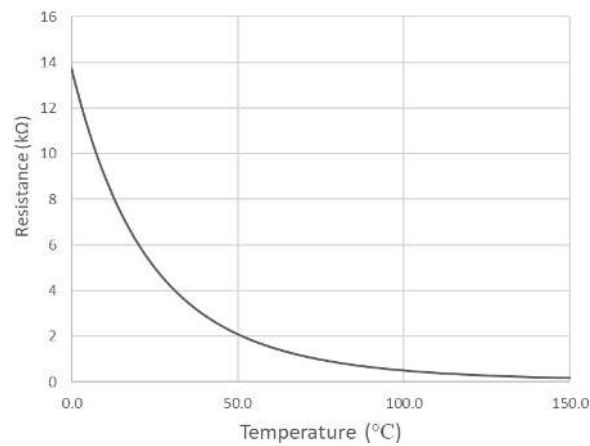

Figure 33. Thermistor Characteristic

NXH240B120H3Q1PG, NXH240B120H3Q1PG-R, NXH240B120H3Q1SG

ORDERING INFORMATION

Orderable Part Number	Marking	Package	Shipping
NXH240B120H3Q1PG, NXH240B120H3Q1PG-R	NXH240B120H3Q1PG, NXH240B120H3Q1PG-R	Q1 BOOST, Case 180AX Press-fit Pins (Pb-Free)	21 Units / Blister Tray
NXH240B120H3Q1SG	NXH240B120H3Q1SG	Q1 BOOST, Case 180BQ Solder Pins (Pb-Free)	21 Units / Blister Tray

MECHANICAL CASE OUTLINE

PACKAGE DIMENSIONS

ON Semiconductor®



PIM30, 71x37.4
CASE 180AD
ISSUE E

DATE 28 NOV 2017

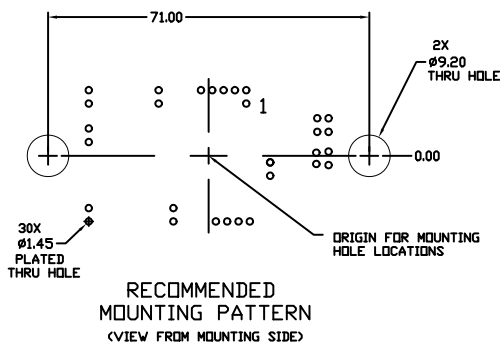
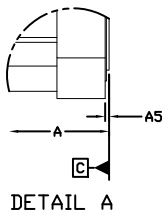
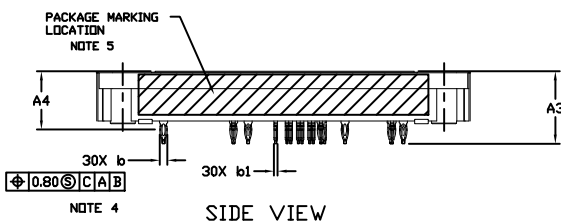
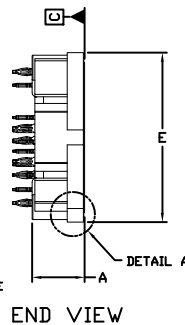
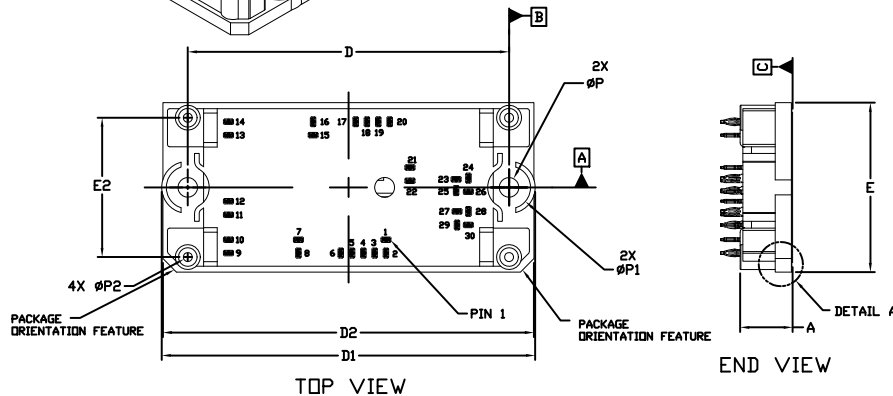
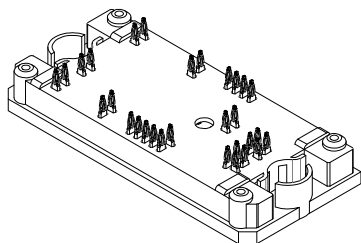

NOTES:

- DIMENSIONING AND TOLERANCING PER ASME Y14.5M, 2009.
- CONTROLLING DIMENSION: MILLIMETERS
- DIMENSIONS b AND b1 APPLY TO THE PLATED TERMINALS AND ARE MEASURED AT DIMENSION A4.
- POSITION OF THE CENTER OF THE TERMINALS IS DETERMINED FROM DATUM B THE CENTER OF DIMENSION D, X DIRECTION, AND FROM DATUM A, Y DIRECTION. POSITIONAL TOLERANCE, AS NOTED IN DRAWING, APPLIES TO EACH TERMINAL IN BOTH DIRECTIONS.
- PACKAGE MARKING IS LOCATED AS SHOWN ON THE SIDE OPPOSITE THE PACKAGE ORIENTATION FEATURES.

MOUNTING HOLE POSITION			MOUNTING HOLE POSITION		
PIN	X	Y	PIN	X	Y
1	8.30	11.55	16	-7.800	-14.50
2	8.30	14.50	17	1.60	-14.50
3	5.80	14.50	18	4.10	-14.50
4	3.30	14.50	19	6.60	-14.50
5	0.80	14.50	20	9.10	-14.50
6	-1.70	14.50	21	13.60	-4.40
7	-11.05	11.55	22	13.60	-1.45
8	-11.05	14.50	23	23.80	-1.80
9	-26.50	14.50	24	26.50	-2.05
10	-26.50	11.55	25	23.80	0.70
11	-26.50	6.05	26	26.50	0.95
12	-26.50	3.05	27	24.00	5.30
13	-26.50	-11.55	28	26.50	5.30
14	-26.50	-14.50	29	24.00	8.30
15	-7.80	-11.55	30	26.50	8.30

NOTE 4

DIM	MILLIMETERS	
	MIN.	NDM.
A	11.10	12.10
A3	15.50	16.50
A4	12.88	BSC
A5	0.00	0.45
b	1.61	1.71
b1	0.75	0.85
D	70.50	71.50
D1	82.00	83.00
D2	81.50	82.50
E	36.90	37.90
E2	30.30	31.30
P	4.30	4.50
P1	9.30	9.70
P2	1.90	2.10

PIN	PIN POSITION		PIN	PIN POSITION	
	X	Y		X	Y
1	8.30	-11.55	16	-7.800	14.50
2	8.30	-14.50	17	1.60	14.50
3	5.80	-14.50	18	4.10	14.50
4	3.30	-14.50	19	6.60	14.50
5	0.80	-14.50	20	9.10	14.50
6	-1.70	-14.50	21	13.60	4.40
7	-11.05	-11.55	22	13.60	1.45
8	-11.05	-14.50	23	23.80	1.80
9	-26.50	-14.50	24	26.50	2.05
10	-26.50	-11.55	25	23.80	-0.70
11	-26.50	-6.05	26	26.50	-0.95
12	-26.50	-3.05	27	24.00	-5.30
13	-26.50	11.55	28	26.50	-5.30
14	-26.50	14.50	29	24.00	-8.30
15	-7.80	11.55	30	26.50	-8.30

GENERIC

MARKING DIAGRAM*

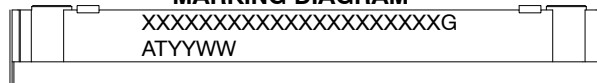

XXXXX = Specific Device Code
G = Pb-Free Package
AT = Assembly & Test Site Code
YYWW = Year and Work Week Code

*This information is generic. Please refer to device data sheet for actual part marking. Pb-Free indicator, "G" or microdot "•", may or may not be present. Some products may not follow the Generic Marking.

DOCUMENT NUMBER:	98AON07115G	Electronic versions are uncontrolled except when accessed directly from the Document Repository. Printed versions are uncontrolled except when stamped "CONTROLLED COPY" in red.
DESCRIPTION:	PIM30 71X37.4 (PRESS FIT)	PAGE 1 OF 1

ON Semiconductor and ON are trademarks of Semiconductor Components Industries, LLC dba ON Semiconductor or its subsidiaries in the United States and/or other countries. ON Semiconductor reserves the right to make changes without further notice to any products herein. ON Semiconductor makes no warranty, representation or guarantee regarding the suitability of its products for any particular purpose, nor does ON Semiconductor assume any liability arising out of the application or use of any product or circuit, and specifically disclaims any and all liability, including without limitation special, consequential or incidental damages. ON Semiconductor does not convey any license under its patent rights nor the rights of others.

MECHANICAL CASE OUTLINE PACKAGE DIMENSIONS

ON Semiconductor®



PIM32, 71x37.4 (PRESS-FIT) CASE 180AX ISSUE O

DATE 25 JAN 2019

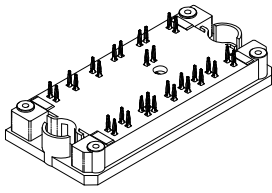

NOTES:

1. DIMENSIONING AND TOLERANCING PER ASME Y14.5M, 2009.
2. CONTROLLING DIMENSION: MILLIMETERS
3. DIMENSIONS b AND b1 APPLY TO THE PLATED TERMINALS AND ARE MEASURED AT DIMENSION A4.
4. POSITION OF THE CENTER OF THE TERMINALS AND MOUNTING HOLES IS DETERMINED FROM DATUM B THE CENTER OF DIMENSION D, X DIRECTION, AND FROM DATUM A, Y DIRECTION. POSITIONAL TOLERANCE, AS NOTED IN DRAWING, APPLIES TO BOTH TERMINALS AND MOUNTING HOLES IN BOTH DIRECTIONS.
5. PACKAGE MARKING IS LOCATED, AS SHOWN, ON THE SIDE OPPOSITE THE PACKAGE ORIENTATION FEATURES.
6. MOUNTING RECOMMENDATION IS SHOWN AS VIEWED FROM THE PCB TOP LAYER LOOKING DOWN TO SUBSEQUENT LAYERS.

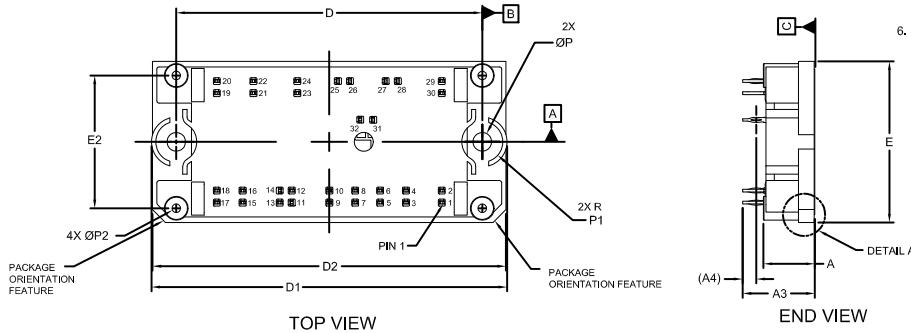

DIM	MILLIMETERS		
	MIN.	NOM.	MAX.
A	11.44	11.94	12.44
A1	10.84	11.34	11.84
A3	16.27	16.77	17.27
A4	3.05	3.15	3.25
A5	0.04	0.24	0.44
b	1.13	1.18	1.23
b1	0.59	0.64	0.69
D	70.50	71.00	71.50
D1	82.00	82.50	83.00
D2	81.50	82.00	82.50
E	36.90	37.40	37.90
E2	30.30	30.80	31.30
P	4.30	4.40	4.50
P1	4.55	4.75	4.95
P2	2.00 REF		

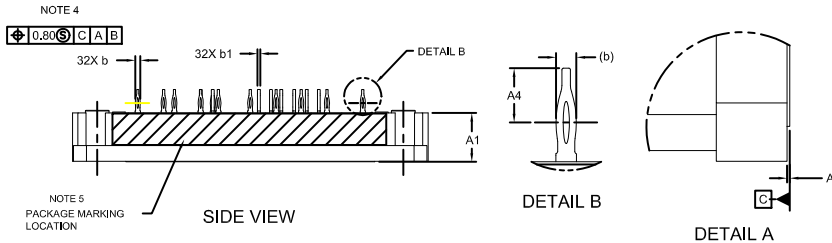

NOTE 5
PACKAGE MARKING
LOCATION

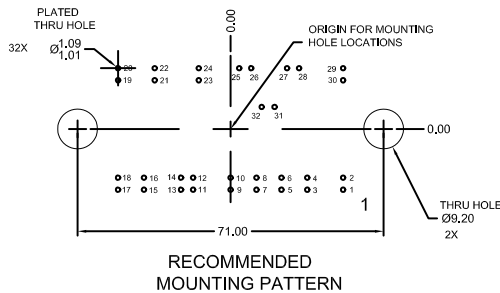

NOTE 4

PIN	PIN POSITION		PIN	PIN POSITION	
	X	Y		X	Y
1	26.10	-14.10	17	-26.10	-14.10
2	26.10	-11.30	18	-26.10	-11.30
3	17.80	-14.10	19	-26.10	11.30
4	17.80	-11.30	20	-26.10	14.10
5	11.80	-14.10	21	-17.60	11.30
6	11.80	-11.30	22	-17.60	14.10
7	6.00	-14.10	23	-7.40	11.30
8	6.00	-11.30	24	-7.40	14.10
9	0.00	-14.10	25	2.00	14.10
10	0.00	-11.30	26	4.80	14.10
11	-8.70	-14.10	27	13.10	14.10
12	-8.70	-11.30	28	15.90	14.10
13	-11.50	-14.10	29	26.10	14.10
14	-11.50	-11.30	30	26.10	11.30
15	-20.10	-14.10	31	10.20	5.10
16	-20.10	-11.30	32	7.20	5.10

GENERIC MARKING DIAGRAM*

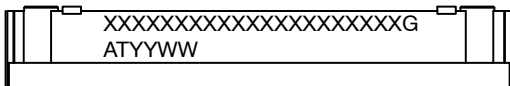

XXXXX = Specific Device Code
G = Pb-Free Package
AT = Assembly & Test Site Code
YYWW = Year and Work Week Code

*This information is generic. Please refer to device data sheet for actual part marking. Pb-Free indicator, "G" or microdot "▪", may or may not be present. Some products may not follow the Generic Marking.

DOCUMENT NUMBER:	98AON02449H	Electronic versions are uncontrolled except when accessed directly from the Document Repository. Printed versions are uncontrolled except when stamped "CONTROLLED COPY" in red.
DESCRIPTION:	PIM32, 71x37.4 (PRESS-FIT)	PAGE 1 OF 1

ON Semiconductor and ON are trademarks of Semiconductor Components Industries, LLC dba ON Semiconductor or its subsidiaries in the United States and/or other countries. ON Semiconductor reserves the right to make changes without further notice to any products herein. ON Semiconductor makes no warranty, representation or guarantee regarding the suitability of its products for any particular purpose, nor does ON Semiconductor assume any liability arising out of the application or use of any product or circuit, and specifically disclaims any and all liability, including without limitation special, consequential or incidental damages. ON Semiconductor does not convey any license under its patent rights nor the rights of others.

onsemi, **Onsemi**, and other names, marks, and brands are registered and/or common law trademarks of Semiconductor Components Industries, LLC dba "**onsemi**" or its affiliates and/or subsidiaries in the United States and/or other countries. **onsemi** owns the rights to a number of patents, trademarks, copyrights, trade secrets, and other intellectual property. A listing of **onsemi**'s product/patent coverage may be accessed at www.onsemi.com/site/pdf/Patent-Marking.pdf. **onsemi** reserves the right to make changes at any time to any products or information herein, without notice. The information herein is provided "as-is" and **onsemi** makes no warranty, representation or guarantee regarding the accuracy of the information, product features, availability, functionality, or suitability of its products for any particular purpose, nor does **onsemi** assume any liability arising out of the application or use of any product or circuit, and specifically disclaims any and all liability, including without limitation special, consequential or incidental damages. Buyer is responsible for its products and applications using **onsemi** products, including compliance with all laws, regulations and safety requirements or standards, regardless of any support or applications information provided by **onsemi**. "Typical" parameters which may be provided in **onsemi** data sheets and/or specifications can and do vary in different applications and actual performance may vary over time. All operating parameters, including "Typicals" must be validated for each customer application by customer's technical experts. **onsemi** does not convey any license under any of its intellectual property rights nor the rights of others. **onsemi** products are not designed, intended, or authorized for use as a critical component in life support systems or any FDA Class 3 medical devices or medical devices with a same or similar classification in a foreign jurisdiction or any devices intended for implantation in the human body. Should Buyer purchase or use **onsemi** products for any such unintended or unauthorized application, Buyer shall indemnify and hold **onsemi** and its officers, employees, subsidiaries, affiliates, and distributors harmless against all claims, costs, damages, and expenses, and reasonable attorney fees arising out of, directly or indirectly, any claim of personal injury or death associated with such unintended or unauthorized use, even if such claim alleges that **onsemi** was negligent regarding the design or manufacture of the part. **onsemi** is an Equal Opportunity/Affirmative Action Employer. This literature is subject to all applicable copyright laws and is not for resale in any manner.

ADDITIONAL INFORMATION

TECHNICAL PUBLICATIONS:

Technical Library: www.onsemi.com/design/resources/technical-documentation
onsemi Website: www.onsemi.com

ONLINE SUPPORT: www.onsemi.com/support

For additional information, please contact your local Sales Representative at www.onsemi.com/support/sales