

STRADA-FT

Forward throw beam for area lighting optimized for XP-G and XP-E. Assembly with installation tape.

SPECIFICATION:

Dimensions	19.6 x 15.5 mm
Height	8.4 mm
Fastening	tape, pin, screw
ROHS compliant	yes ⓘ

MATERIALS:

Component	Type	Material	Colour	Finish
STRADA-FT	Single lens	PMMA	clear	
VOSU-WU-M-365-TAPE	Tape	Acrylic foam		

ORDERING INFORMATION:

Component	Type	Qty in box	MOQ	MPQ	Box weight (kg)
CA12050_STRADA-FT » Box size: 451 x 254 x 197 mm	Single lens	3600	240	240	5.4



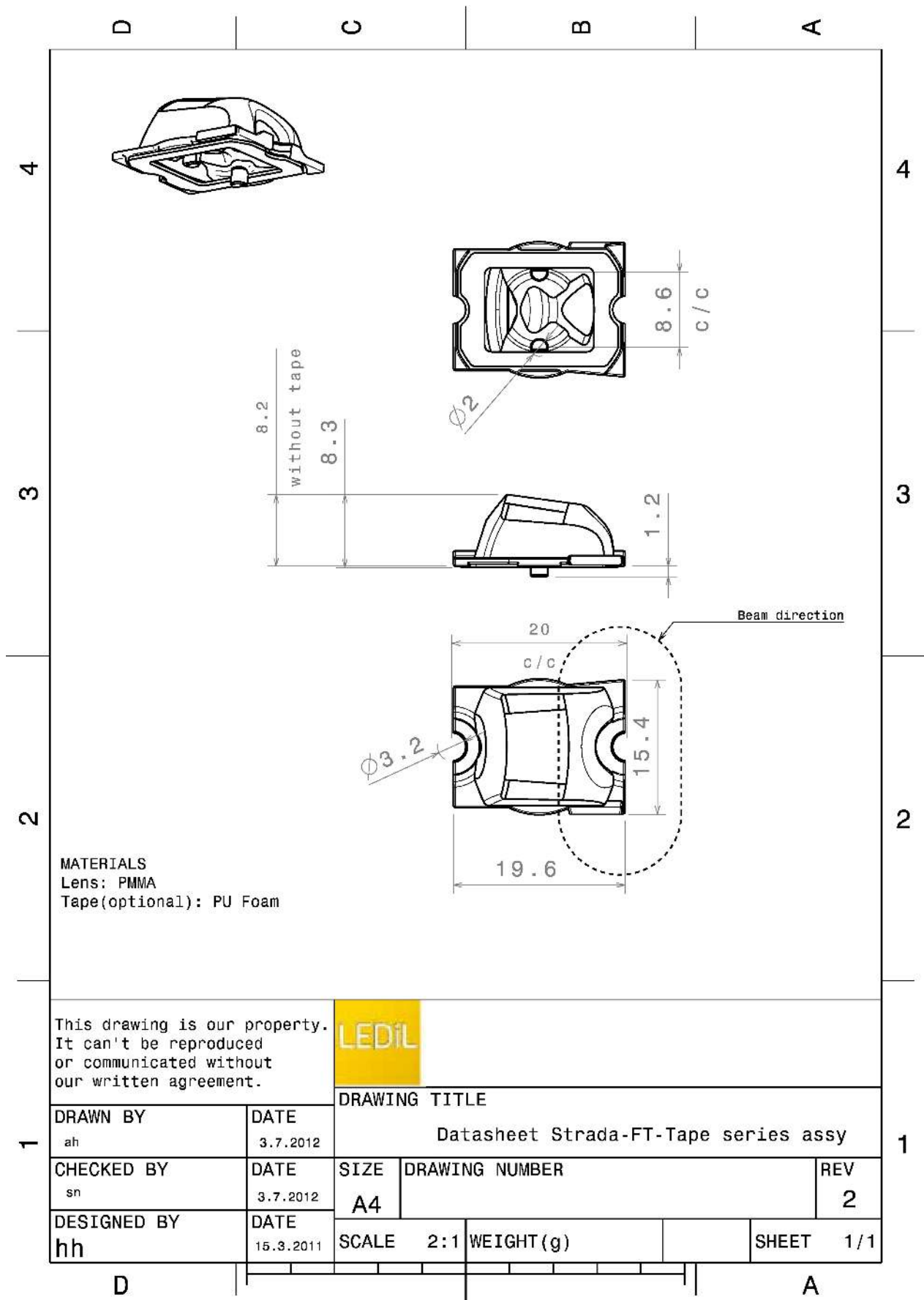

This drawing is our property. It can't be reproduced or communicated without our written agreement.



DRAWN BY ah		DATE 3.7.2012	DRAWING TITLE Datasheet Strada-FT-Tape series assy		
CHECKED BY sn	DATE 3.7.2012	SIZE A4	DRAWING NUMBER		REV 2
DESIGNED BY hh	DATE 15.3.2011	SCALE 2:1	WEIGHT (g)	SHEET 1/1	

See also our general installation guide: www.ledil.com/installation_guide

OPTICAL RESULTS (MEASURED):



LED XB-D
FWHM / FWTM Asymmetric
Efficiency 87 %
LEDs/each optic 1
Light colour White
Required components:



LED XP-E
FWHM / FWTM Asymmetric
Efficiency 92 %
LEDs/each optic 1
Light colour White
Required components:



LED LUXEON A
FWHM / FWTM Asymmetric
Efficiency 87 %
LEDs/each optic 1
Light colour White
Required components:



LED LUXEON Rebel
FWHM / FWTM Asymmetric
Efficiency 92 %
LEDs/each optic 1
Light colour White
Required components:

OPTICAL RESULTS (MEASURED):

LUMILEDS

LED LUXEON Rebel ES
FWHM / FWTM Asymmetric
Efficiency 92 %
LEDs/each optic 1
Light colour White
Required components:

LUMILEDS

LED LUXEON Z ES
FWHM / FWTM Asymmetric
Efficiency 86 %
Peak intensity 0.6 cd/lm
LEDs/each optic 1
Light colour White
Required components:

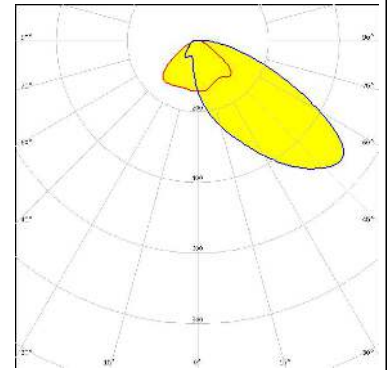





NICHIA

LED NCSxx19A
FWHM / FWTM Asymmetric
Efficiency 92 %
LEDs/each optic 1
Light colour White
Required components:

NICHIA

LED NVSxx19A
FWHM / FWTM Asymmetric
Efficiency 92 %
LEDs/each optic 1
Light colour White
Required components:

OPTICAL RESULTS (MEASURED):

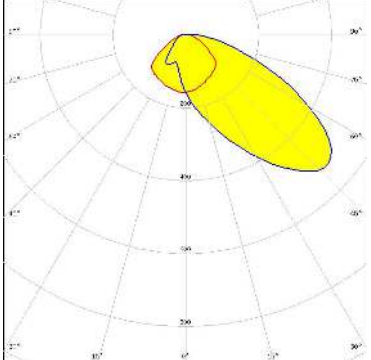
 <small>Opto Semiconductors</small>	
LED	OSLON SSL 150
FWHM / FWTM	Asymmetric
Efficiency	92 %
LEDs/each optic	1
Light colour	White
Required components:	
 <small>Opto Semiconductors</small>	
LED	OSLON SSL 80
FWHM / FWTM	Asymmetric
Efficiency	92 %
LEDs/each optic	1
Light colour	White
Required components:	
 <small>SECOIL SEMICONDUCTOR</small>	
LED	Z5
FWHM / FWTM	Asymmetric
Efficiency	92 %
LEDs/each optic	1
Light colour	White
Required components:	
 <small>SECOIL SEMICONDUCTOR</small>	
LED	Z5M1/Z5M2
FWHM / FWTM	Asymmetric
Efficiency	87 %
LEDs/each optic	1
Light colour	White
Required components:	
	

OPTICAL RESULTS (MEASURED):

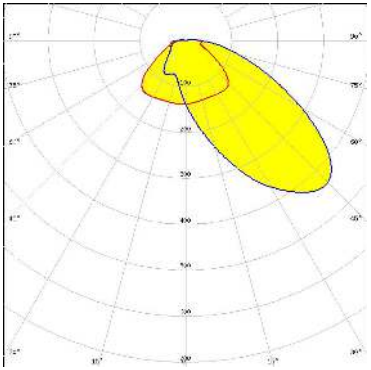
		
LED	Z8Y22P	
FWHM / FWTM	Asymmetric	
Efficiency	86 %	
Peak intensity	0.4 cd/lm	
LEDs/each optic	1	
Light colour	White	
Required components:		
SHARP		
LED	Double Dome (GM2BB)	
FWHM / FWTM	Asymmetric	
Efficiency	92 %	
LEDs/each optic	1	
Light colour	White	
Required components:		

OPTICAL RESULTS (SIMULATED):

CREE LED

LED XP-G
 FWHM / FWTM Asymmetric
 Efficiency 91 %
 Peak intensity 0.6 cd/lm
 LEDs/each optic 1
 Light colour White
 Required components:

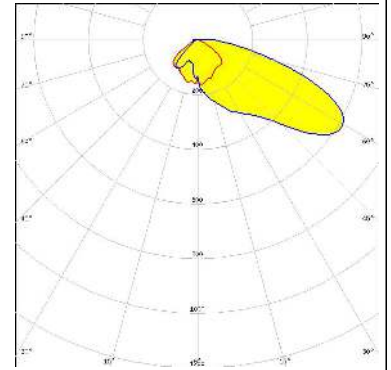

CREE LED

LED XP-G
 FWHM / FWTM Asymmetric
 Efficiency 74 %
 Peak intensity 0.5 cd/lm
 LEDs/each optic 1
 Light colour White
 Required components:

Protective plate, glass

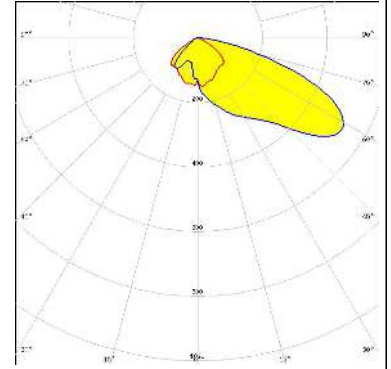

LUMILEDS

LED LUXEON 2835 Line
 FWHM / FWTM Asymmetric
 Efficiency 93 %
 Peak intensity 1.6 cd/lm
 LEDs/each optic 1
 Light colour White
 Required components:

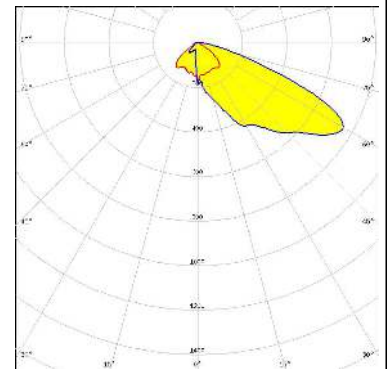

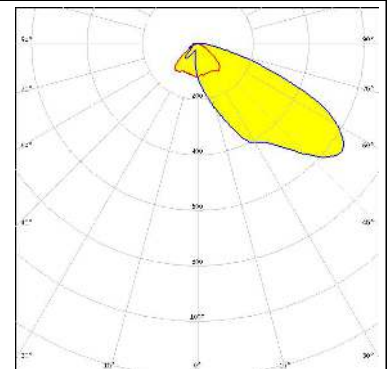

LUMILEDS

LED LUXEON 3030 2D (Round LES)
 FWHM / FWTM Asymmetric
 Efficiency 88 %
 Peak intensity 0.7 cd/lm
 LEDs/each optic 1
 Light colour White
 Required components:

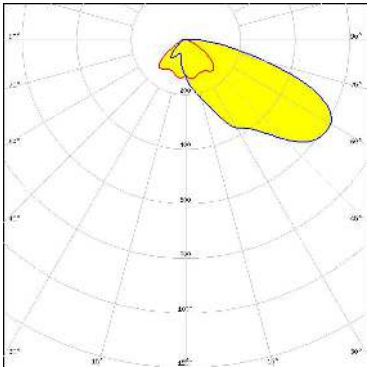

OPTICAL RESULTS (SIMULATED):

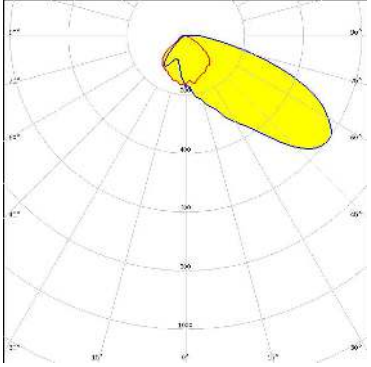
		
LED	NVSxx19B/NVSxx19C	
FWHM / FWTM	Asymmetric	
Efficiency	92 %	
Peak intensity	0.7 cd/lm	
LEDs/each optic	1	
Light colour	White	
Required components:		
		
LED	LH351B	
FWHM / FWTM	Asymmetric	
Efficiency	87 %	
Peak intensity	0.6 cd/lm	
LEDs/each optic	1	
Light colour	White	
Required components:		

GENERAL INFORMATION:

NOTE: The typical beam angle will be changed by different color, chip size and chip position tolerance. The typical total beam angle is the full angle measured where the luminous intensity is half of the peak value.

MATERIALS:

As part of our continuous research and improvement processes, and to ensure the best possible quality and availability of our products, LEDiL reserves the right to change material grades without notice.

PRODUCT DATA USER AGREEMENT AND DISCLAIMER:

The measured data in the provided downloadable LEDiL Product Datasheets and Mechanical 2D-Drawings is rounded and provided as reference for planning. LEDiL Oy's optical specifications have been verified by conducting performance testing of the products in accordance with the company's quality system. The reported data are averaged results of multiple measurements with typical variation. LEDiL Oy reserves the right to without prior notification make changes and improvements to its products.

LEDiL Oy assumes neither warranty, nor guarantee nor any other liability of any kind for the contents and correctness of the provided data. The provided data has been generated with highest diligence but the provided data may in reality not represent the complete possible variation range of all intrinsic parameters. Therefore, in certain cases a deviation from the provided data could occur.

LEDiL Oy reserves the right to undertake technical changes of its products without further notification which could lead to changes in the provided data. LEDiL Oy assumes no liability of any kind for the possible deviation from any provided data or any other damage resulting from the usage of the provided data.

The user agrees to this disclaimer and user agreement with the download or usage of the provided files.

LEDiL Oy

Joensuunkatu 13
FI-24240 SALO
Finland

LEDiL Inc.

228 West Page Street
Suite D
Sycamore IL 60178
USA

Ledil Optics Technology (Shenzhen) Co., Ltd.

405 , Block B
Casic Motor Building
Shenzhen 518057
P.R.CHINA

Local sales and technical support

[www.ledil.com/
where_to_buy](http://www.ledil.com/where_to_buy)

Shipping locations

Salo, Finland
Hong Kong, China

Distribution Partners

[www.ledil.com/
where_to_buy](http://www.ledil.com/where_to_buy)