



Mallory Sonalert Products, Inc.

Part #:

SCE048LD3VC1S

Sales Outline Drawing

Revision:

A

Specifications:

Sound Level Category:	Loud	Medium	Soft
Mode of Operation:	Continuous	Continuous	Continuous
Loudness @ 2 FT:	85 to 95 dB(A) Typ.	75 to 85 dB(A) Typ.	65 to 75 dB(A) Typ.
Frequency:	2900 ± 500 Hz	2900 ± 500 Hz	2900 ± 500 Hz
Connection:	TERMINALS ONLY	TERMINALS; BLUE WIRE TO (-)	TERMINALS; YELLOW WIRE TO (-)
Voltage Rating:	28 to 48 VDC		
Current Draw:	40mA MAX		
Housing Material:	6/6 Nylon, Color: Black		
Storage Temperature:	-40° to +85° C		
Operating Temperature:	-40° to +85° C		
Panel Mounting:	Recommended hole size is 1.25"(31.75mm). Thread front will fit standard 30mm(1.181") hole.		
Knurled Nut:	Used to attach part to panel. The max recommended torque is 10 in-lbs.		
Weight (Typical):	1.6 oz (45g)		
NEMA 3R,4X, & 12:	Approved with use of ACC03.		
cUL Recognition:	cUL Recognized		
Options:	Please contact factory.		

Dimensions: Inches (mm)

ROHS Compliant

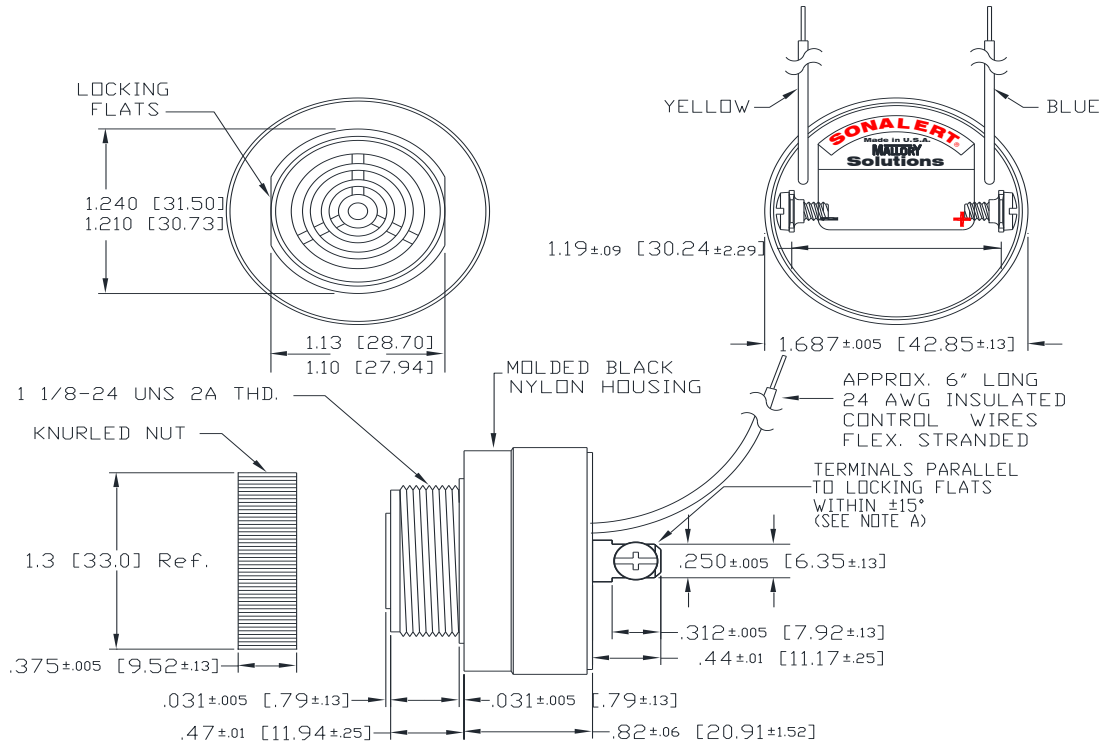

NOTE A: TERMINALS-.032 BRASS TIN PLATED, TAPPED FOR #6-32 SCREW. TWO #6-32 NICKEL PLATED BRASS SCREWS INCLUDED. WILL ACCEPT 1/4" QUICK CONNECT.

NOTE B: MOUNTING- REMOVE BLACK PLASTIC NUT AND INSERT THREADED FRONT THROUGH 1.25" HOLE PUNCHED IN PANEL, IF ORIENTATION IS NEEDED, NOTE LOCKING FLATS ON DRAWING. SCREW NUT BACK ON. DO NOT OVERTIGHTEN.