

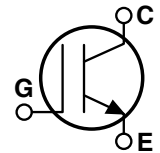

The POWER MOS 7<sup>®</sup> IGBT is a new generation of high voltage power IGBTs. Using Punch Through Technology this IGBT is ideal for many high frequency, high voltage switching applications and has been optimized for high frequency switchmode power supplies.

- Low Conduction Loss
- Low Gate Charge
- Ultrafast Tail Current shutoff
- SSOA Rated

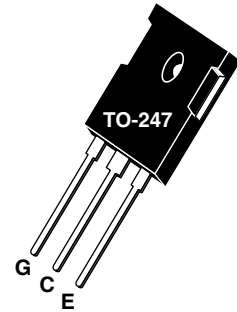

**MAXIMUM RATINGS**

All Ratings:  $T_C = 25^\circ\text{C}$  unless otherwise specified.

Symbol	Parameter	APT40GP90B	UNIT
$V_{CES}$	Collector-Emitter Voltage	900	Volts
$V_{GE}$	Gate-Emitter Voltage	$\pm 20$	
$V_{GEM}$	Gate-Emitter Voltage Transient	$\pm 30$	
$I_{C1}$	Continuous Collector Current <sup>⑦</sup> @ $T_C = 25^\circ\text{C}$	100	Amps
$I_{C2}$	Continuous Collector Current @ $T_C = 110^\circ\text{C}$	50	
$I_{CM}$	Pulsed Collector Current <sup>①</sup> @ $T_C = 150^\circ\text{C}$	160	
SSOA	Switching Safe Operating Area @ $T_J = 150^\circ\text{C}$	160A @ 900V	
$P_D$	Total Power Dissipation	543	Watts
$T_J, T_{STG}$	Operating and Storage Junction Temperature Range	-55 to 150	$^\circ\text{C}$
$T_L$	Max. Lead Temp. for Soldering: 0.063" from Case for 10 Sec.	300	

**STATIC ELECTRICAL CHARACTERISTICS**

Symbol	Characteristic / Test Conditions	MIN	TYP	MAX	UNIT
$BV_{CES}$	Collector-Emitter Breakdown Voltage ( $V_{GE} = 0V, I_C = 250\mu\text{A}$ )	900			Volts
$V_{GE(TH)}$	Gate Threshold Voltage ( $V_{CE} = V_{GE}, I_C = 1\text{mA}, T_J = 25^\circ\text{C}$ )	3	4.5	6	
$V_{CE(ON)}$	Collector-Emitter On Voltage ( $V_{GE} = 15V, I_C = 40A, T_J = 25^\circ\text{C}$ )		3.2	3.9	
	Collector-Emitter On Voltage ( $V_{GE} = 15V, I_C = 40A, T_J = 125^\circ\text{C}$ )		2.7		
$I_{CES}$	Collector Cut-off Current ( $V_{CE} = V_{CES}, V_{GE} = 0V, T_J = 25^\circ\text{C}$ ) <sup>②</sup>			250	$\mu\text{A}$
	Collector Cut-off Current ( $V_{CE} = V_{CES}, V_{GE} = 0V, T_J = 125^\circ\text{C}$ ) <sup>②</sup>			1000	
$I_{GES}$	Gate-Emitter Leakage Current ( $V_{GE} = \pm 20V$ )			$\pm 100$	nA

**CAUTION:** These Devices are Sensitive to Electrostatic Discharge. Proper Handling Procedures Should Be Followed.

APT Website - <http://www.advancedpower.com>

## DYNAMIC CHARACTERISTICS

APT40GP90B

Symbol	Characteristic	Test Conditions	MIN	TYP	MAX	UNIT
$C_{ies}$	Input Capacitance	<b>Capacitance</b> $V_{GE} = 0V, V_{CE} = 25V$ $f = 1 \text{ MHz}$		3300		pF
$C_{oes}$	Output Capacitance			325		
$C_{res}$	Reverse Transfer Capacitance			35		
$V_{GEP}$	Gate-to-Emitter Plateau Voltage	<b>Gate Charge</b> $V_{GE} = 15V$ $V_{CE} = 450V$ $I_C = 40A$		7.5		V
$Q_g$	Total Gate Charge <sup>③</sup>			145		nC
$Q_{ge}$	Gate-Emitter Charge			22		
$Q_{gc}$	Gate-Collector ("Miller") Charge			55		
SSOA	Switching Safe Operating Area	$T_J = 150^\circ\text{C}, R_G = 5\Omega, V_{GE} = 15V, L = 100\mu\text{H}, V_{CE} = 900V$	160			A
$t_{d(on)}$	Turn-on Delay Time	<b>Inductive Switching (25°C)</b> $V_{CC} = 600V$ $V_{GE} = 15V$ $I_C = 40A$ $R_G = 5\Omega$ $T_J = +25^\circ\text{C}$		16		ns
$t_r$	Current Rise Time			27		
$t_{d(off)}$	Turn-off Delay Time			75		
$t_f$	Current Fall Time			60		
$E_{on1}$	Turn-on Switching Energy <sup>④</sup>				TBD	$\mu\text{J}$
$E_{on2}$	Turn-on Switching Energy (Diode) <sup>⑤</sup>				1415	
$E_{off}$	Turn-off Switching Energy <sup>⑥</sup>				825	
$t_{d(on)}$	Turn-on Delay Time	<b>Inductive Switching (125°C)</b> $V_{CC} = 600V$ $V_{GE} = 15V$ $I_C = 40A$ $R_G = 5\Omega$ $T_J = +125^\circ\text{C}$		16		ns
$t_r$	Current Rise Time			27		
$t_{d(off)}$	Turn-off Delay Time			110		
$t_f$	Current Fall Time			105		
$E_{on1}$	Turn-on Switching Energy <sup>④4</sup>				TBD	$\mu\text{J}$
$E_{on2}$	Turn-on Switching Energy (Diode) <sup>⑤5</sup>				2370	
$E_{off}$	Turn-off Switching Energy <sup>⑥6</sup>				1505	

## THERMAL AND MECHANICAL CHARACTERISTICS

Symbol	Characteristic	MIN	TYP	MAX	UNIT
$R_{\theta JC}$	Junction to Case (IGBT)			.23	$^\circ\text{C/W}$
$R_{\theta JC}$	Junction to Case (DIODE)			N/A	
$W_T$	Package Weight			5.90	gm

- ① Repetitive Rating: Pulse width limited by maximum junction temperature.
- ② For Combi devices,  $I_{ces}$  includes both IGBT and FRED leakages
- ③ See MIL-STD-750 Method 3471.
- ④  $E_{on1}$  is the clamped inductive turn-on-energy of the IGBT only, without the effect of a commutating diode reverse recovery current adding to the IGBT turn-on loss. (See Figure 24.)
- ⑤  $E_{on2}$  is the clamped inductive turn-on energy that includes a commutating diode reverse recovery current in the IGBT turn-on switching loss. (See Figures 21, 22.)
- ⑥  $E_{off}$  is the clamped inductive turn-off energy measured in accordance with JEDEC standard JESD24-1. (See Figures 21, 23.)
- ⑦ Continuous current limited by package lead temperature.

APT Reserves the right to change, without notice, the specifications and information contained herein.

# TYPICAL PERFORMANCE CURVES

APT40GP90B

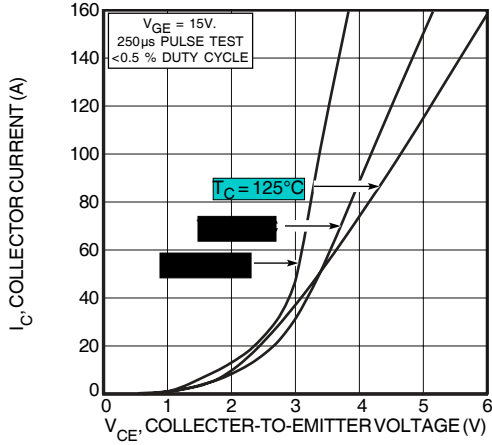

FIGURE 1, Output Characteristics ( $V_{GE} = 15V$ )

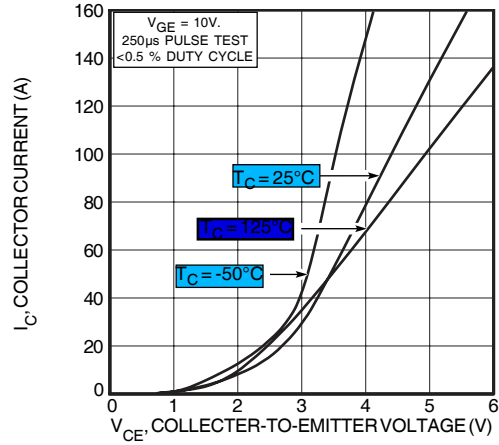

FIGURE 2, Output Characteristics ( $V_{GE} = 10V$ )

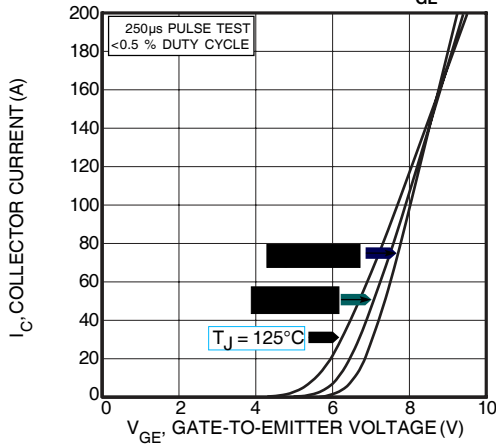

FIGURE 3, Transfer Characteristics

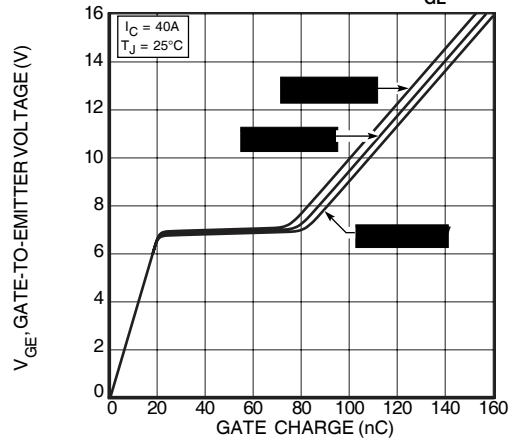

FIGURE 4, Gate Charge

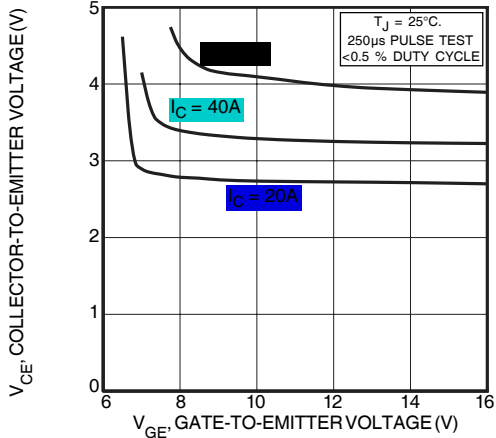

FIGURE 5, On State Voltage vs Gate-to-Emitter Voltage

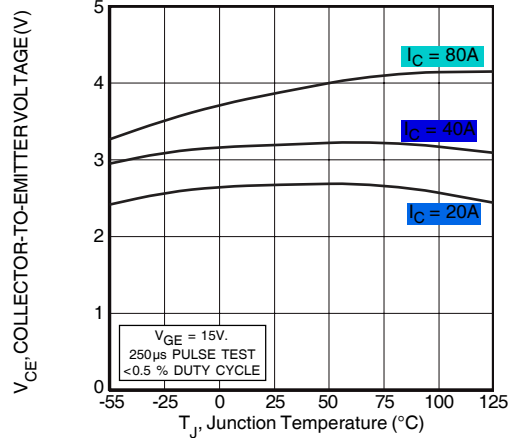

FIGURE 6, On State Voltage vs Junction Temperature

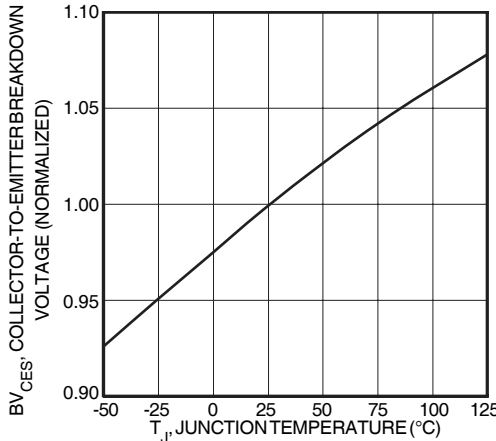

FIGURE 7, Breakdown Voltage vs. Junction Temperature

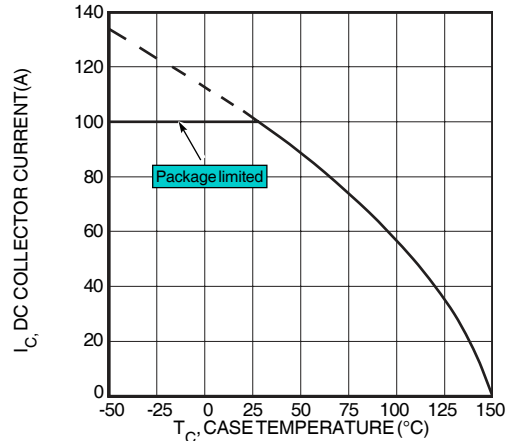

FIGURE 8, DC Collector Current vs Case Temperature

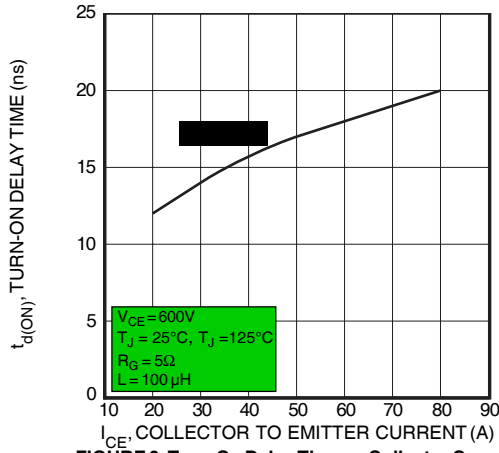

FIGURE 9, Turn-On Delay Time vs Collector Current

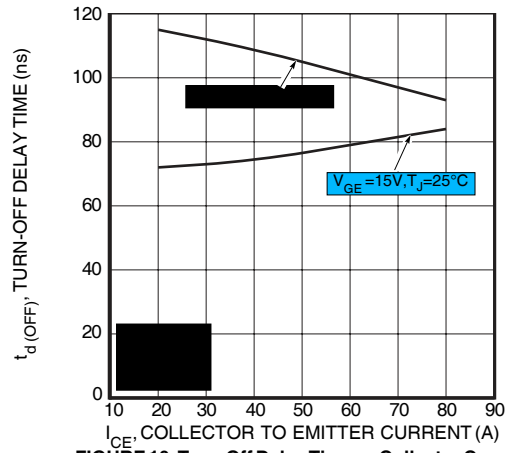

FIGURE 10, Turn-Off Delay Time vs Collector Current

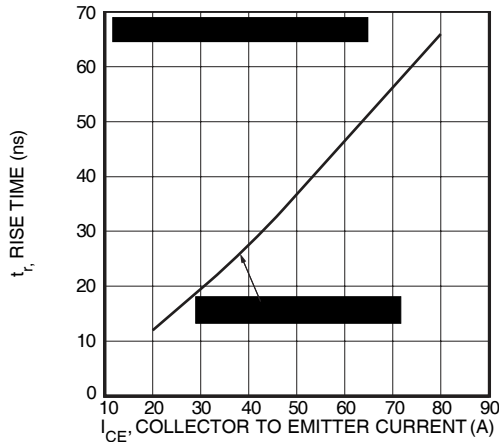

FIGURE 11, Current Rise Time vs Collector Current

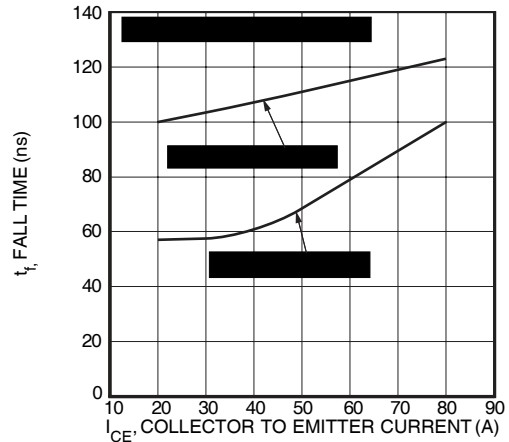

FIGURE 12, Current Fall Time vs Collector Current

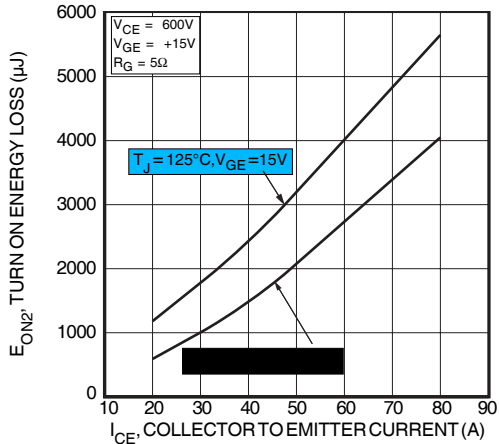

FIGURE 13, Turn-On Energy Loss vs Collector Current

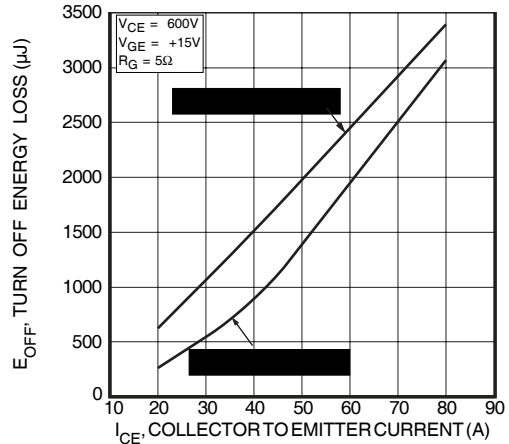

FIGURE 14, Turn Off Energy Loss vs Collector Current

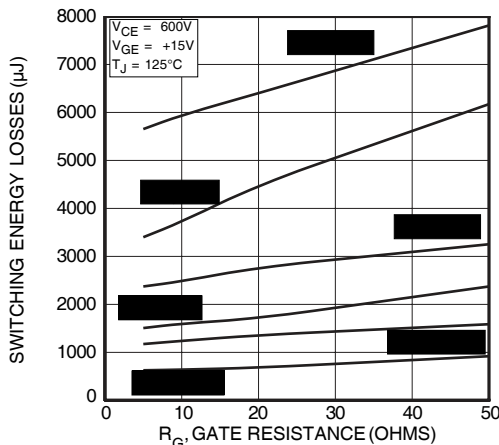

FIGURE 15, Switching Energy Losses vs. Gate Resistance

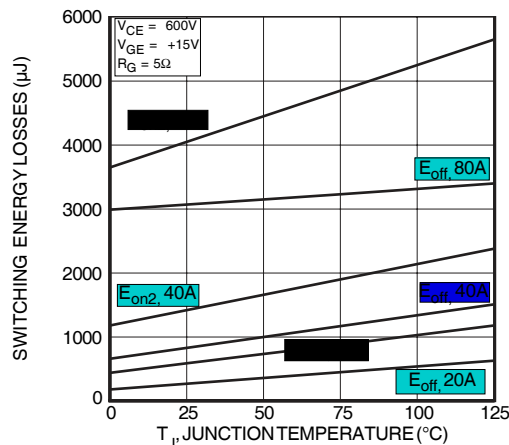

FIGURE 16, Switching Energy Losses vs Junction Temperature

# TYPICAL PERFORMANCE CURVES

APT40GP90B

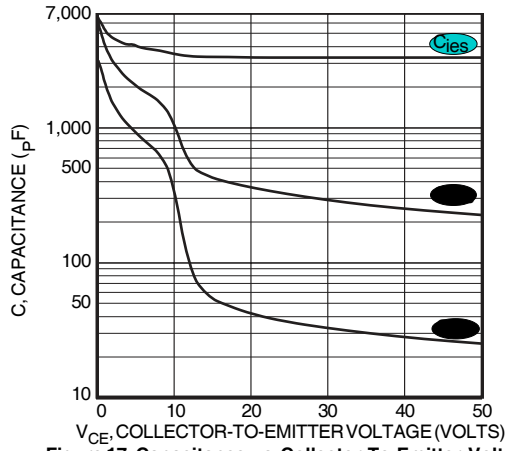

Figure 17, Capacitance vs Collector-To-Emitter Voltage

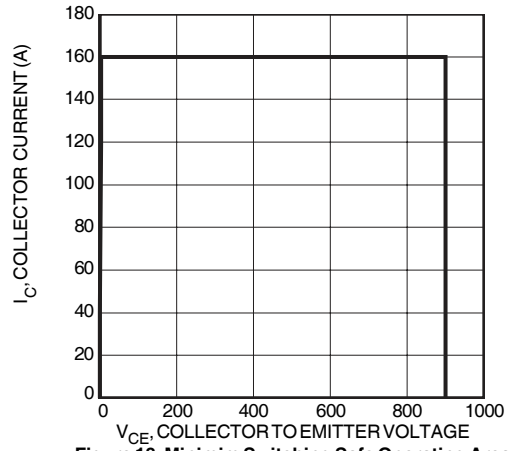

Figure 18, Minimum Switching Safe Operating Area

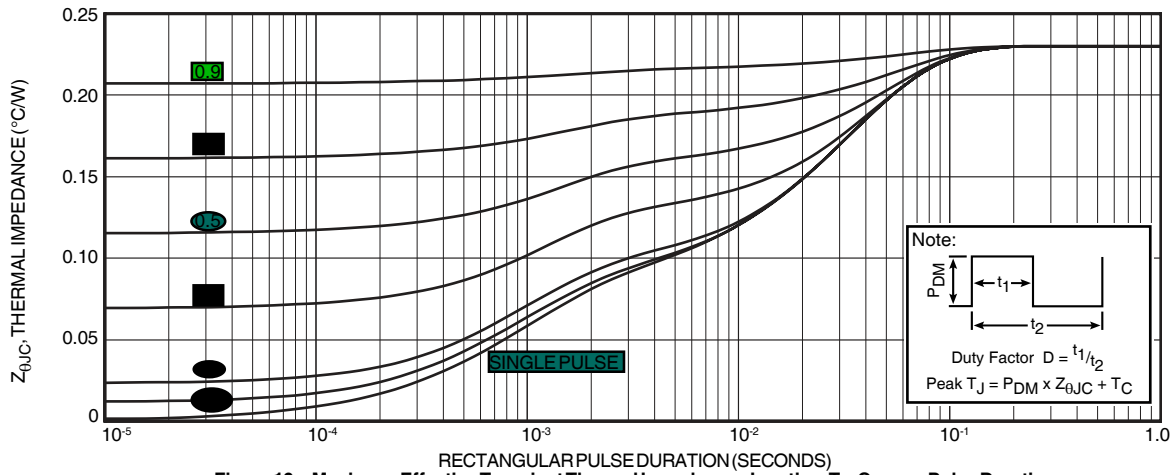

Figure 19a, Maximum Effective Transient Thermal Impedance, Junction-To-Case vs Pulse Duration

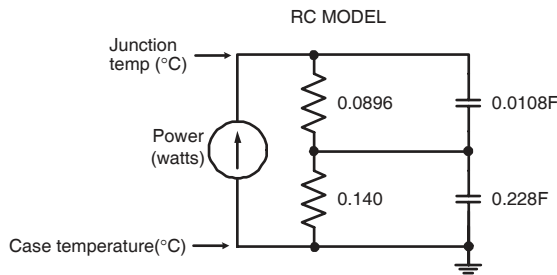

FIGURE 19b, TRANSIENT THERMAL IMPEDANCE MODEL

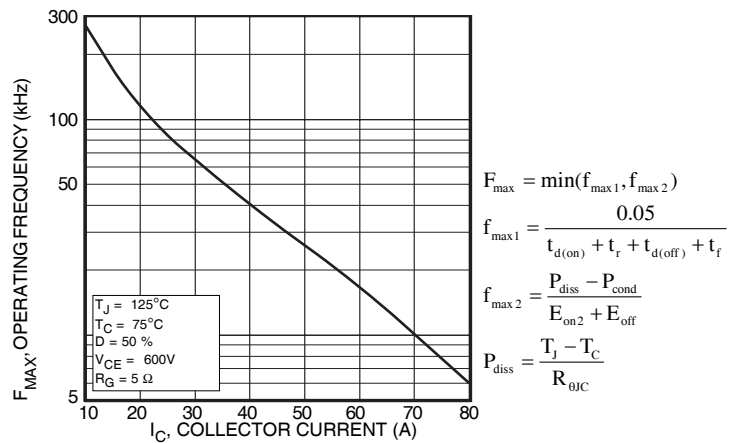

Figure 20, Operating Frequency vs Collector Current

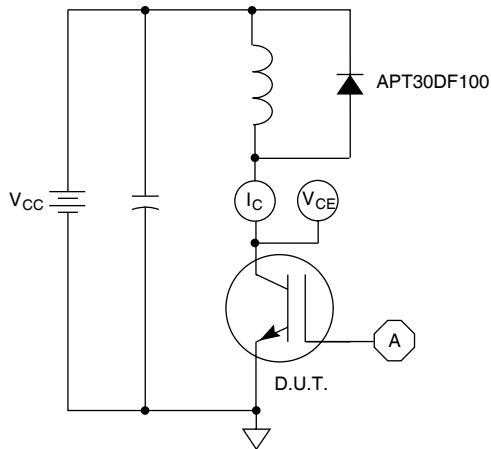

Figure 21, Inductive Switching Test Circuit

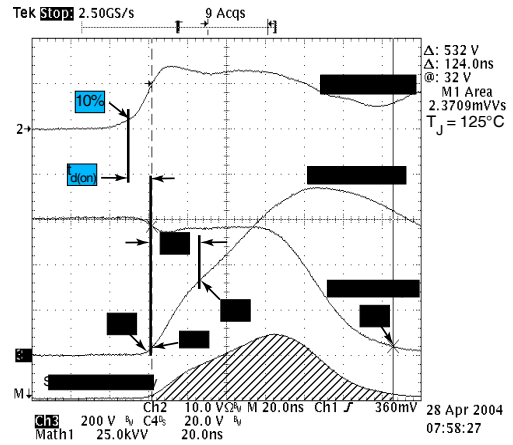

Figure 22, Turn-on Switching Waveforms and Definitions

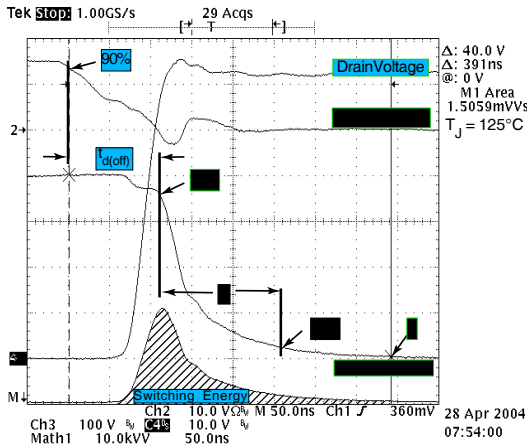

Figure 23, Turn-off Switching Waveforms and Definitions

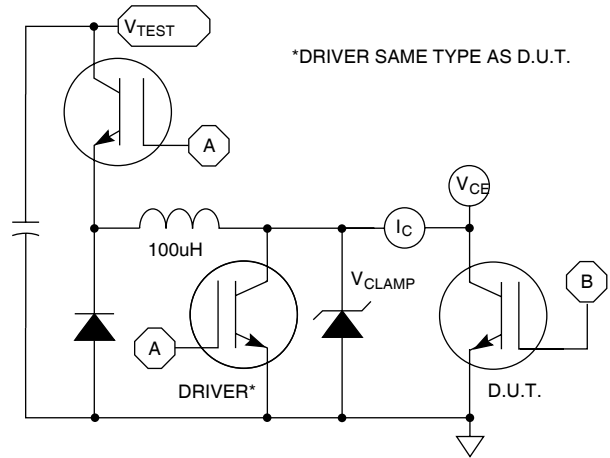
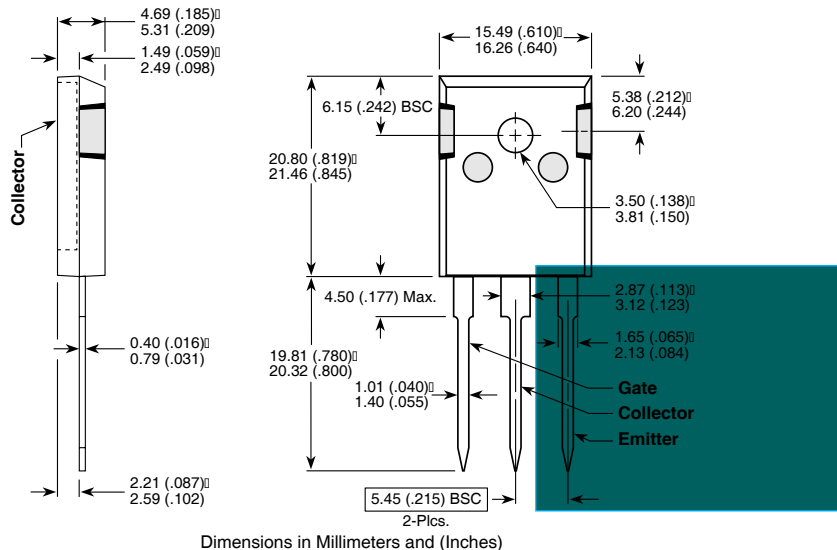

Figure 24, EON1 Test Circuit

T0-247 Package Outline



Dimensions in Millimeters and (Inches)

APT's products are covered by one or more of U.S. patents 4,895,810 5,045,903 5,089,434 5,182,234 5,019,522 5,262,336 6,503,786 5,256,583 4,748,103 5,283,202 5,231,474 5,434,095 5,528,058 and foreign patents. US and Foreign patents pending. All Rights Reserved.