

- NOTES:
- MATERIAL:
 - HOUSINGS: LCP UL94, V-0, COLOR: BLACK
 - TERMINALS: HIGH CONDUCTIVITY COPPER ALLOY
 - PLATING: 1.27 MICROMETER (50 MICROINCH) NICKEL OVERALL WITH 2.54 MICROMETER (100 MICROINCH) SELECTIVE TIN ON TAILS AND 0.762 MICROMETER (30 MICROINCH) SELECTIVE GOLD ON CONTACT AREA
 - PACKAGING: ASSEMBLIES TO BE TRAY PACKED PER PACKAGING SPEC: 1710881001-PK
 - PLATED THRU HOLE SIZE, REFER TO PS-171088-0000 FOR DETAILS
 - PRODUCT SPEC: PS-171088-0000
 - PRODUCT TO MEET RoHS REQUIREMENTS
 - ASSEMBLY MATES TO MOLEX RECEPTACLE ASSEMBLY P/N 171089-**** AND 171090-**** (SEE TABLE IN SHEET 2)
 - TAIL DESIGN: COMPLIANT TAIL
 - POWER AND SIGNAL CONTACTS ARE LUBRICATED.
 - APPLICATION SPEC: AS-46436-100..
 - MOLEX LOGO TO BE LOCATED APPROXIMATELY AS SHOWN.

THIS DRAWING CONTAINS INFORMATION THAT IS PROPRIETARY TO MOLEX ELECTRONIC TECHNOLOGIES, LLC AND SHOULD NOT BE USED WITHOUT WRITTEN PERMISSION									
DIMENSION UNITS	SCALE	CURRENT REV DESC: ADDED ISO VIEWS							
mm	3:1								
GENERAL TOLERANCES (UNLESS SPECIFIED)									
ANGULAR TOL	± 0.5°								
4 PLACES	±	EC NO: 689821							
3 PLACES	±	DRWN: KSUTAR		2021/12/15					
2 PLACES	± 0.13	CHK'D: GJEEVANSURES		2021/12/22					
1 PLACE	± 0.25	APPR: HTHYAGARAJ		2022/02/14					
0 PLACES	±	INITIAL REVISION:							
DRAFT WHERE APPLICABLE MUST REMAIN WITHIN DIMENSIONS		DRWN: KSUTAR		2021/09/23					
		APPR: HTHYAGARAJ		2021/11/08					
THIRD ANGLE PROJECTION		DRAWING		SERIES					
D-SIZE		171088		MATERIAL NUMBER		CUSTOMER		SHEET NUMBER	
				SEE TABLE		GENERAL MARKET		1 OF 4	

RECOMMENDED PCB LAYOUT AND KEEP-OUT ZONE FOR G-(1SP TO 5SP)-30S-(1SP TO 5SP)-G

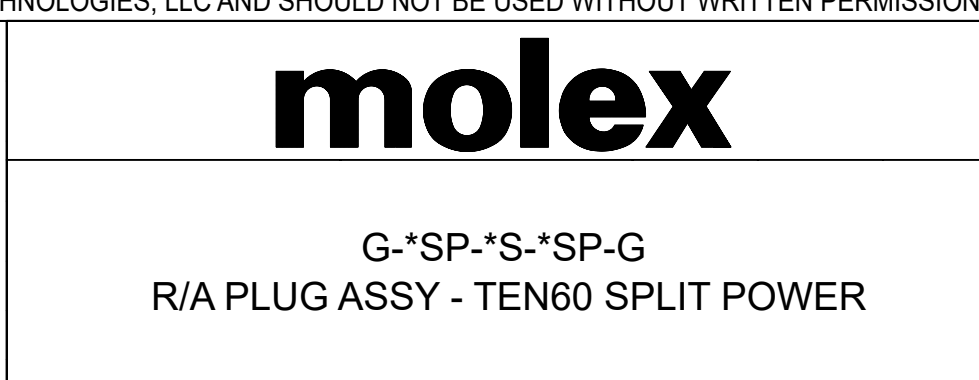

G-*SP-*S-*SP-G
R/A PLUG ASSY - TEN60 SPLIT POWER

PRODUCT CUSTOMER DRAWING

DOCUMENT NUMBER 1710888430 DOC TYPE PSD DOC PART 000 REVISION A1

MATERIAL NUMBER SEE TABLE CUSTOMER GENERAL MARKET SHEET NUMBER 1 OF 4

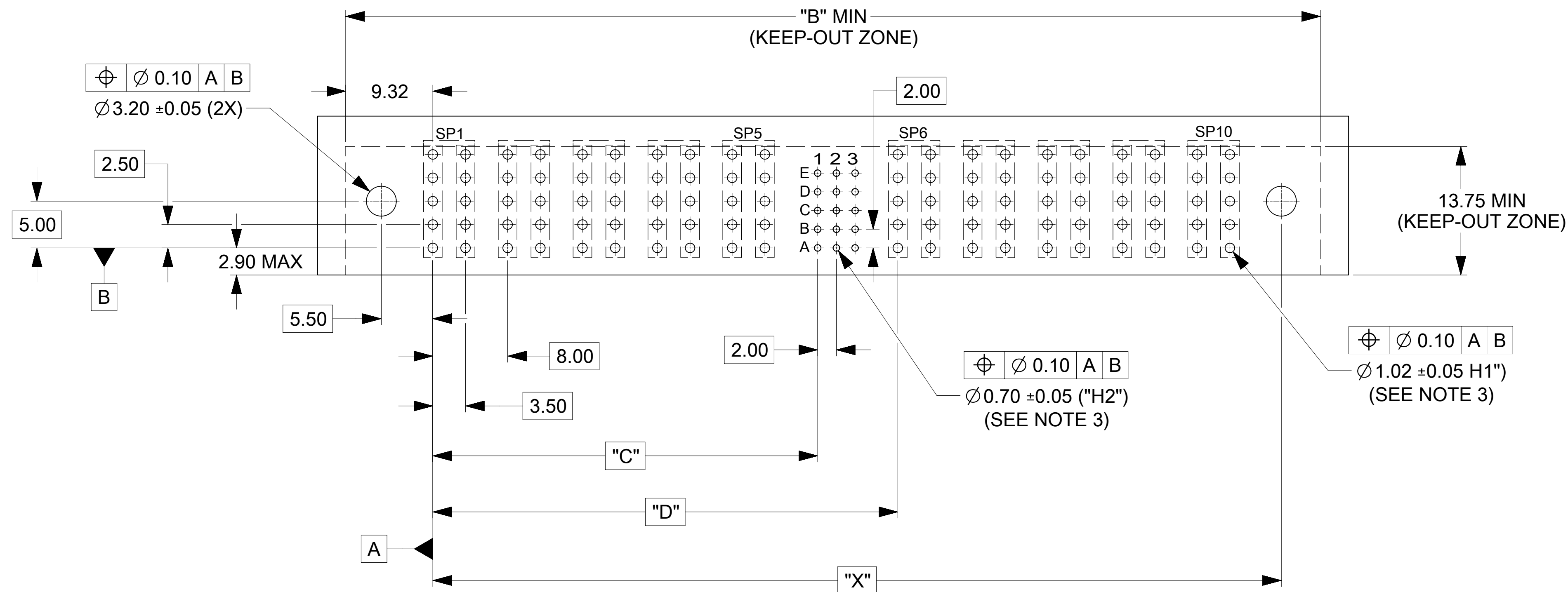

RECOMMENDED PCB LAYOUT AND KEEP-OUT ZONE FOR G-(1SP TO 5SP)-15S-(1SP TO 5SP)-G

REFER TO BELOW TABLE FOR DIMENSIONS.

FG P/N	CONFIGURATION	POWER CKT SIZE	SIGNAL CKT SIZE	DIM "A" (IN MM)	DIM "B" (IN MM)	DIM "C" (IN MM)	DIM "D" (IN MM)	DIM "X" (IN MM)	HOLES COUNT "H1"	HOLES COUNT "H2"	MATES WITH R/A ASSY P/N	MATES WITH VERT ASSY P/N
1710888421	G-1SP-15S-1SP-G	1	15	39.21	40.21	9.14	17.71	26.71	20	15	1710908421	1710898421
1710888422	G-2SP-15S-2SP-G	2	15	55.21	56.21	17.14	25.71	42.71	40	15	1710908422	1710898422
1710888423	G-3SP-15S-3SP-G	3	15	71.21	72.21	25.14	33.71	58.71	60	15	1710908423	1710898423
1710888424	G-4SP-15S-4SP-G	4	15	87.21	88.21	33.14	41.71	74.71	80	15	1710908424	1710898424
1710888425	G-5SP-15S-5SP-G	5	15	103.21	104.21	41.14	49.71	90.71	100	15	1710908425	1710898425
1710888426	G-1SP-30S-1SP-G	1	30	45.21	46.21	9.14	23.71	32.71	20	30	1710908426	1710898426
1710888427	G-2SP-30S-2SP-G	2	30	61.21	62.21	17.14	31.71	48.71	40	30	1710908427	1710898427
1710888428	G-3SP-30S-3SP-G	3	30	77.21	78.21	25.14	39.71	64.71	60	30	1710908428	1710898428
1710888429	G-4SP-30S-4SP-G	4	30	93.21	94.21	33.14	47.71	80.71	80	30	1710908429	1710898429
1710888430	G-5SP-30S-5SP-G	5	30	109.21	110.21	41.14	55.71	96.71	100	30	1710908430	1710898430

THIS DRAWING CONTAINS INFORMATION THAT IS PROPRIETARY TO MOLEX ELECTRONIC TECHNOLOGIES, LLC AND SHOULD NOT BE USED WITHOUT WRITTEN PERMISSION

DIMENSION UNITS mm	SCALE 3:1	CURRENT REV DESC: ADDED ISO VIEWS		molex			
GENERAL TOLERANCES (UNLESS SPECIFIED)		EC NO: 689821					
ANGULAR TOL	± 0.5°	4 PLACES ±		PRODUCT CUSTOMER DRAWING			
		3 PLACES ±		DRWN: KSUTAR 2021/12/15		DOCUMENT NUMBER	
		2 PLACES ± 0.13		CHK'D: GJEEVANSURES 2021/12/22		DOC TYPE DOC PART REVISION	
		1 PLACE ± 0.25		APPR: HTHYAGARAJ 2022/02/14		1710888430 PSD 000 A1	
		0 PLACES ±		INITIAL REVISION: DRWN: KSUTAR 2021/09/23 APPR: HTHYAGARAJ 2021/11/08		MATERIAL NUMBER CUSTOMER	
DRAFT WHERE APPLICABLE MUST REMAIN WITHIN DIMENSIONS		THIRD ANGLE PROJECTION	DRAWING	SERIES	MATERIAL NUMBER	CUSTOMER	SHEET NUMBER
			D-SIZE	171088	SEE TABLE	GENERAL MARKET	2 OF 4

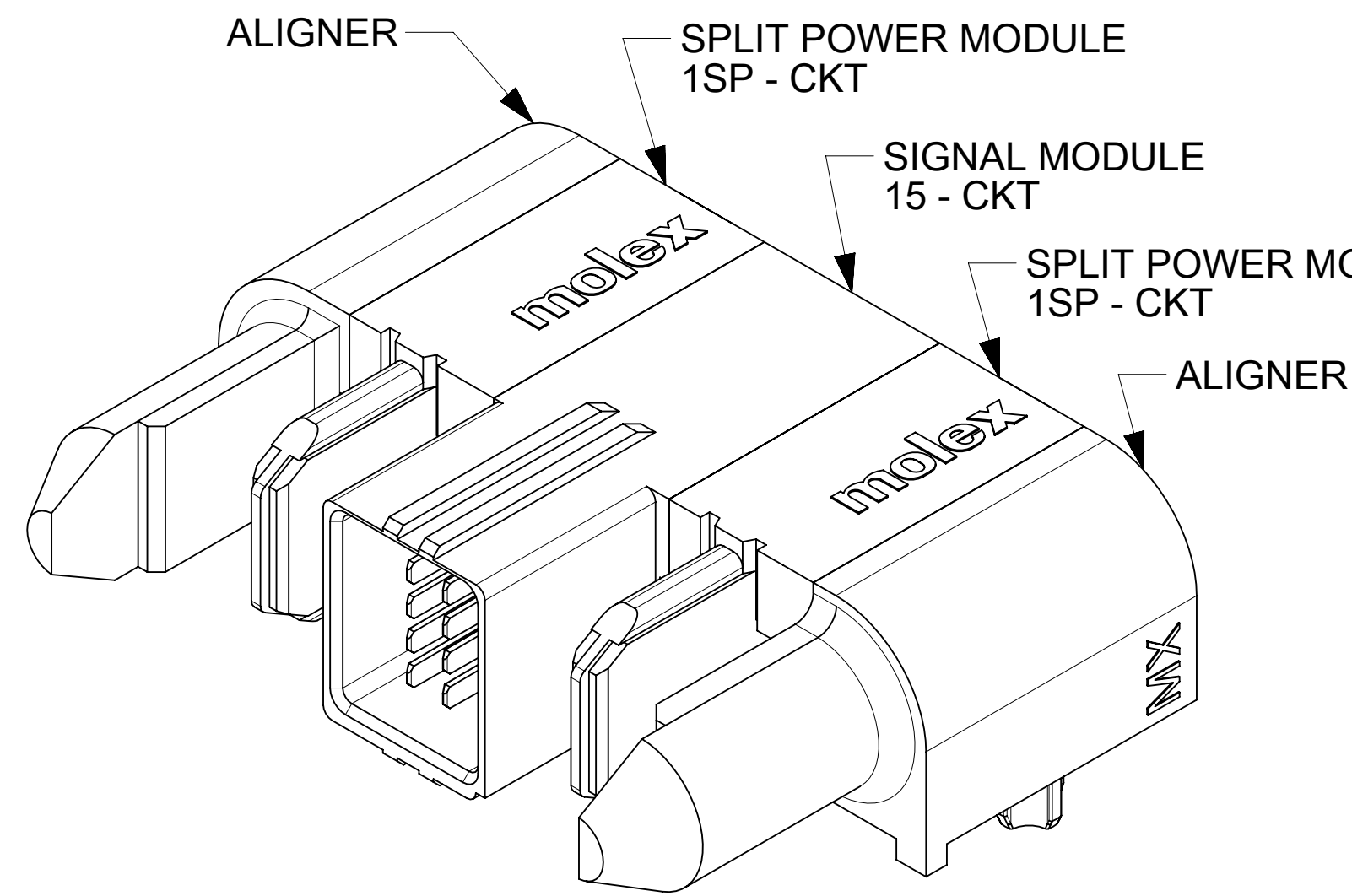

P/N: 171088-8421 (G-1SP-15S-1SP-G)

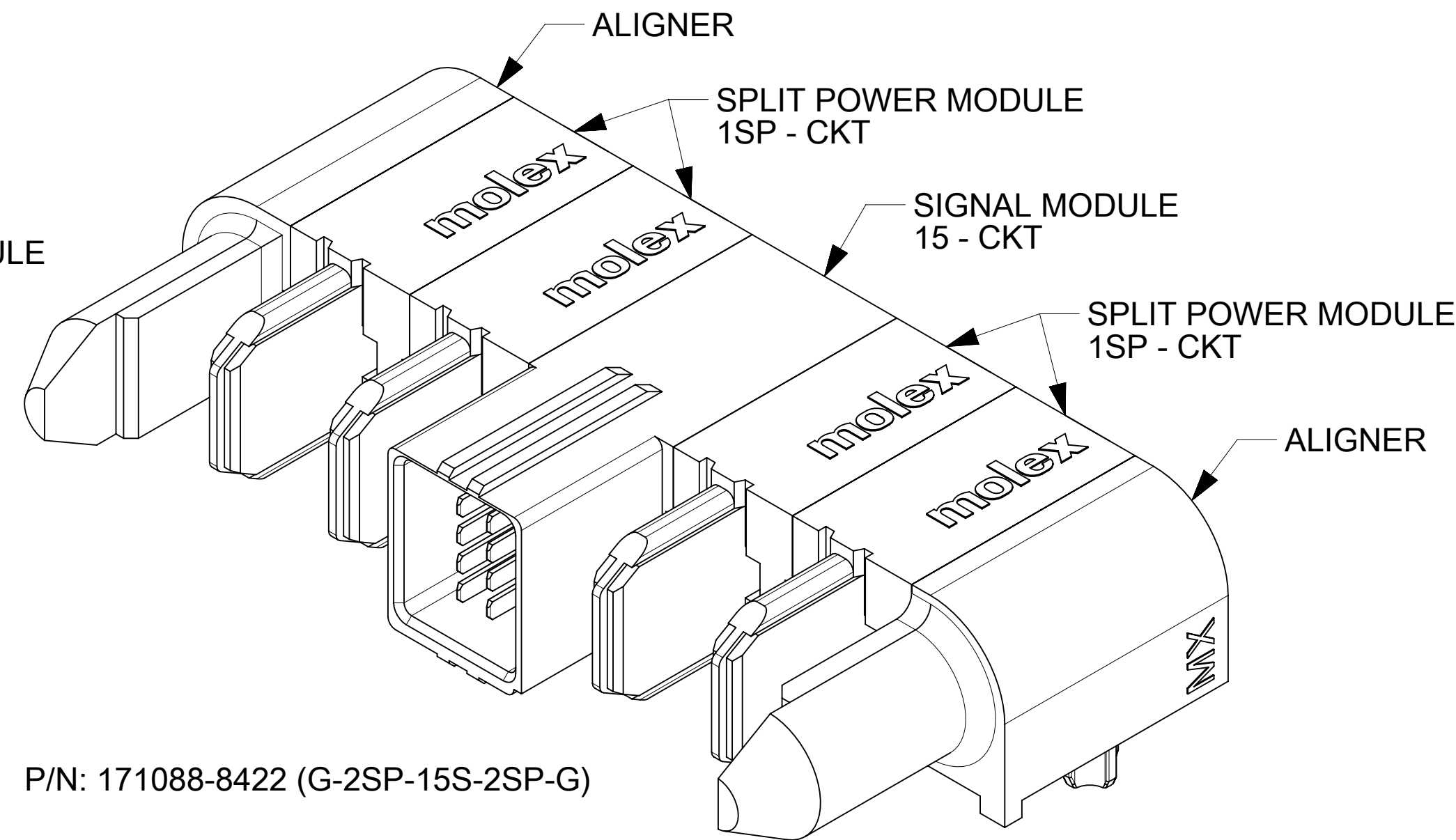

P/N: 171088-8422 (G-2SP-15S-2SP-G)

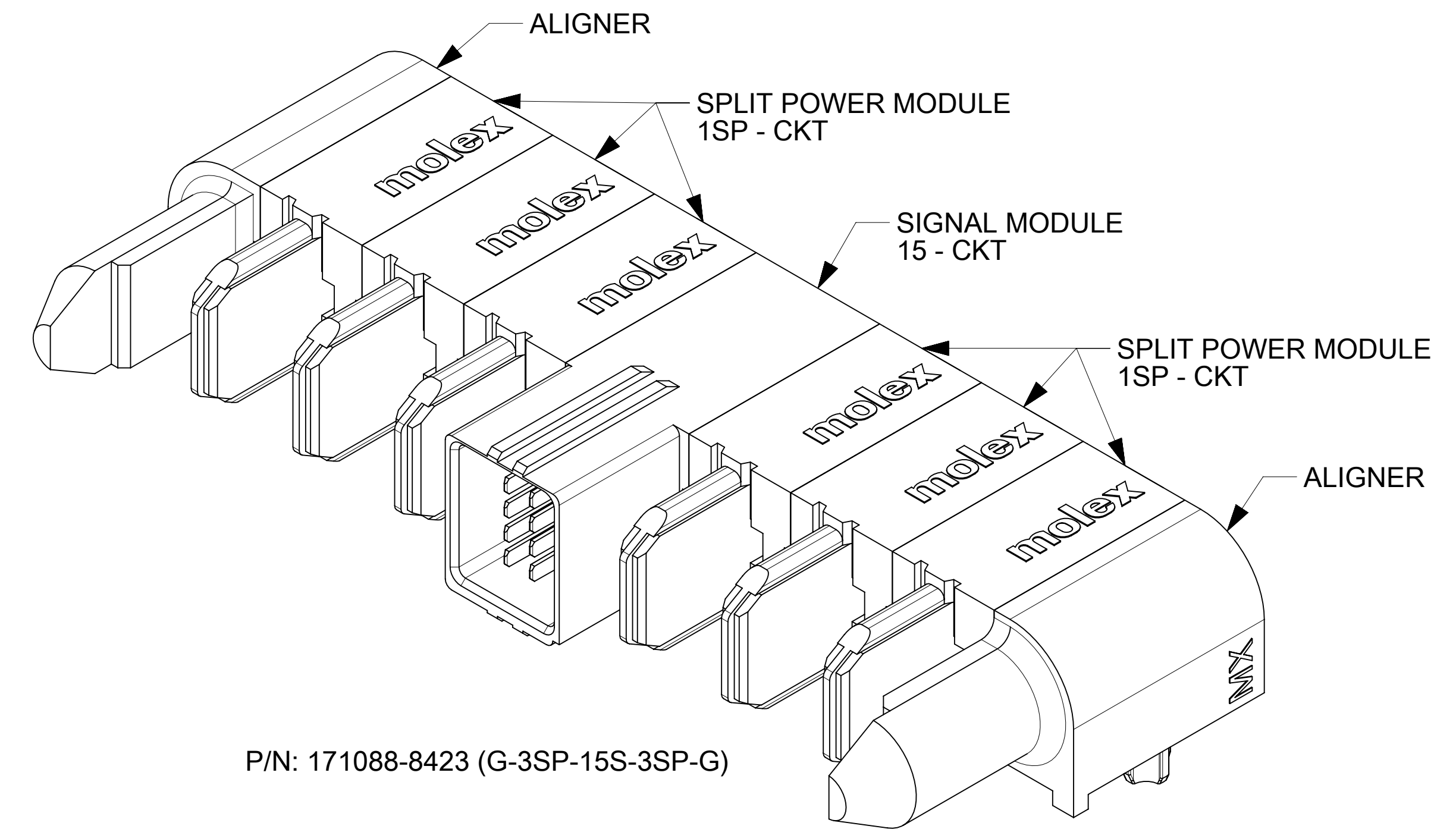

P/N: 171088-8423 (G-3SP-15S-3SP-G)

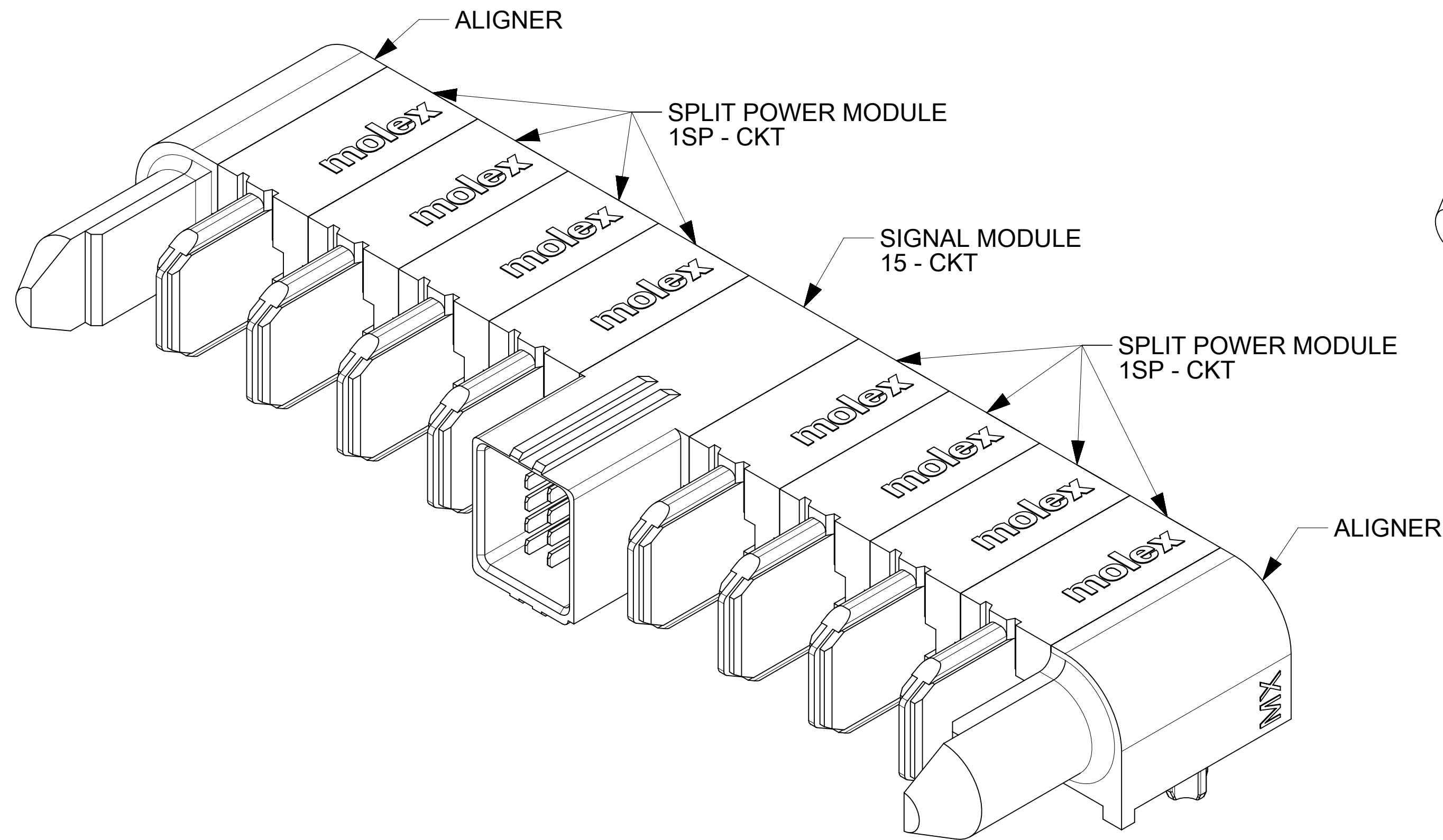

P/N: 171088-8424 (G-4SP-15S-4SP-G)

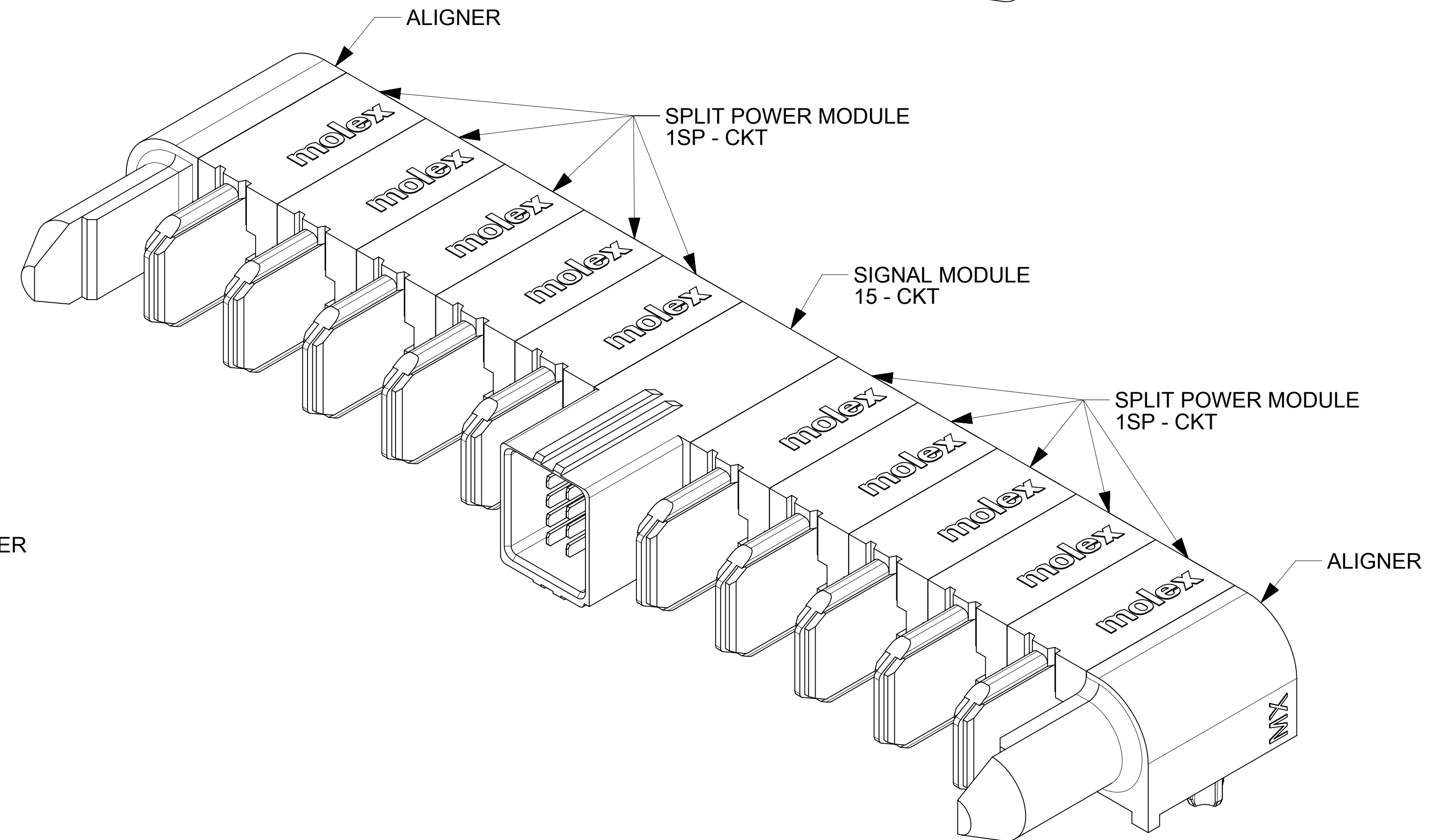

P/N: 171088-8425 (G-5SP-15S-5SP-G)

THIS DRAWING CONTAINS INFORMATION THAT IS PROPRIETARY TO MOLEX ELECTRONIC TECHNOLOGIES, LLC AND SHOULD NOT BE USED WITHOUT WRITTEN PERMISSION									
DIMENSION UNITS	SCALE	CURRENT REV DESC: ADDED ISO VIEWS							
mm	4:1								
GENERAL TOLERANCES (UNLESS SPECIFIED)									
ANGULAR TOL	± 0.5°								
4 PLACES	±	EC NO: 689821							
3 PLACES	±	DRWN: KSUTAR 2021/12/15							
2 PLACES	± 0.13	CHK'D: GJEEVANSURES 2021/12/22							
1 PLACE	± 0.25	APPR: HTHYAGARAJ 2022/02/14							
0 PLACES	±	INITIAL REVISION:							
DRAFT WHERE APPLICABLE MUST REMAIN WITHIN DIMENSIONS		THIRD ANGLE PROJECTION		DRAWING	SERIES	MATERIAL NUMBER			
				D-SIZE	171088	1710888430			
DOCUMENT STATUS		RELEASE DATE		CUSTOMER		SHEET NUMBER			
P1	2022/02/14 09:02:22	GENERAL MARKET		3 OF 4					

molex

G-*SP-*S-*SP-G
R/A PLUG ASSY - TEN60 SPLIT POWER

PRODUCT CUSTOMER DRAWING

DOCUMENT NUMBER	DOC TYPE	DOC PART	REVISION
1710888430	PSD	000	A1

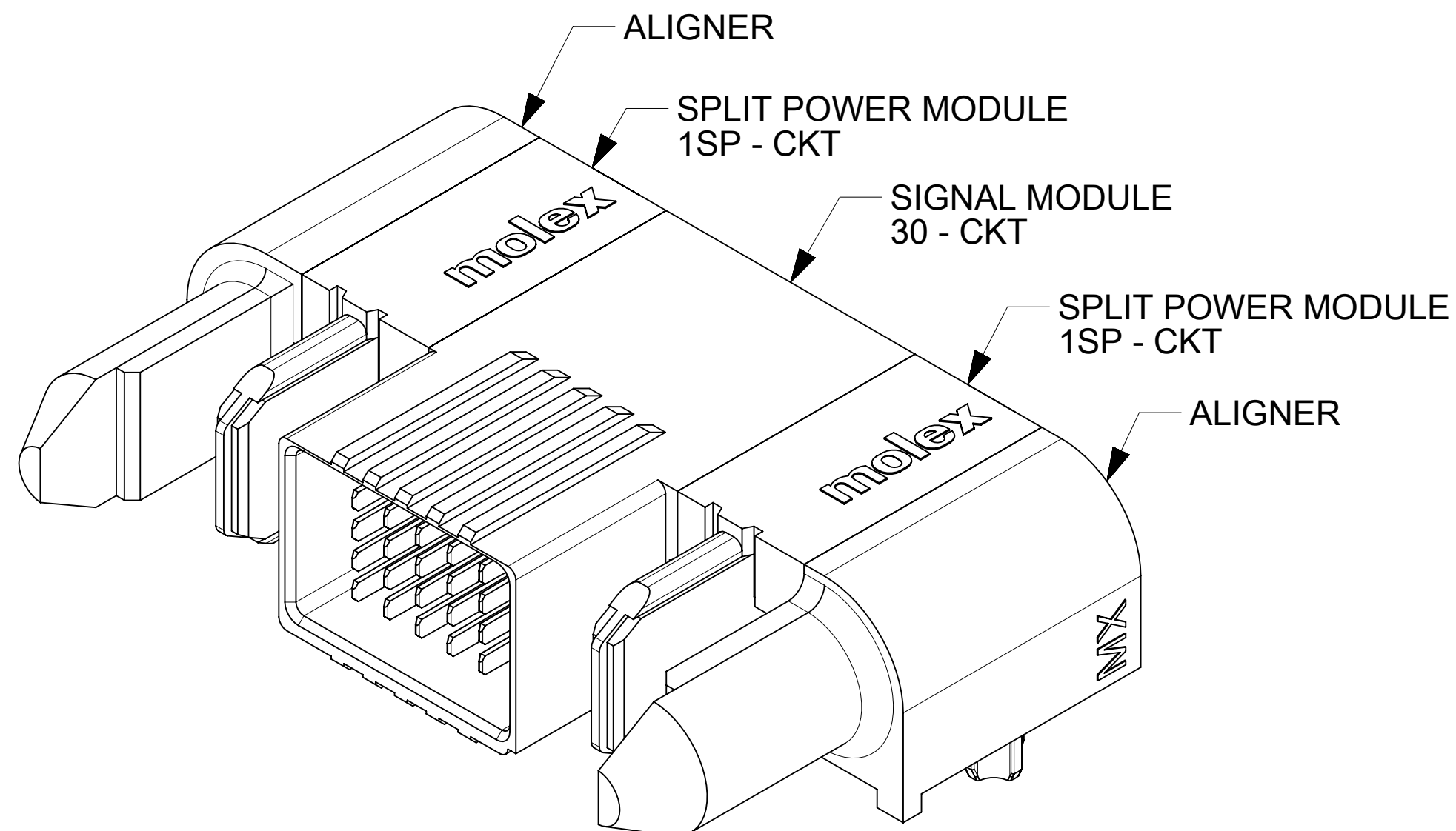

P/N: 171088-8426 (G-1SP-30S-1SP-G)

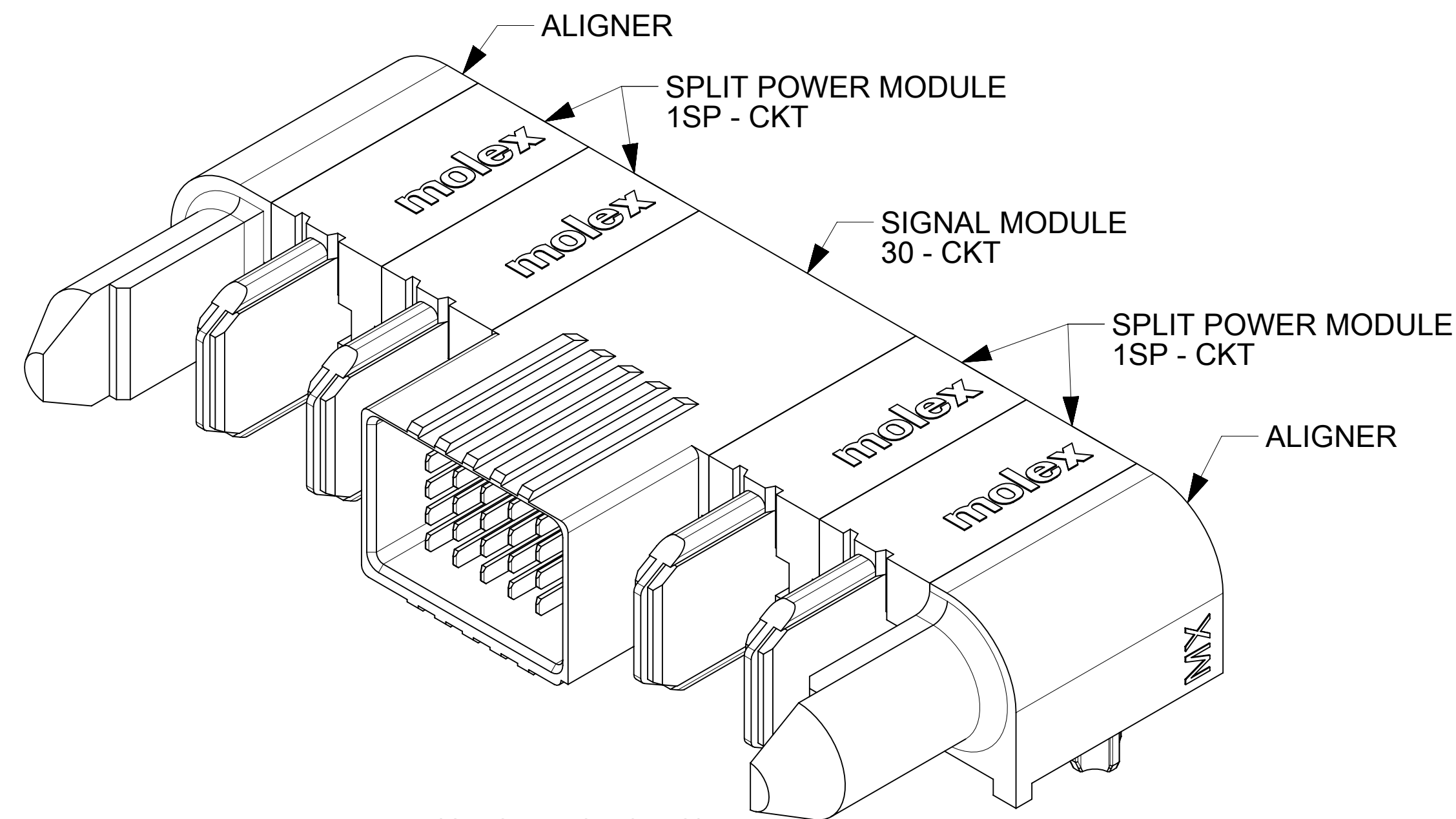

P/N: 171088-8427 (G-2SP-30S-2SP-G)

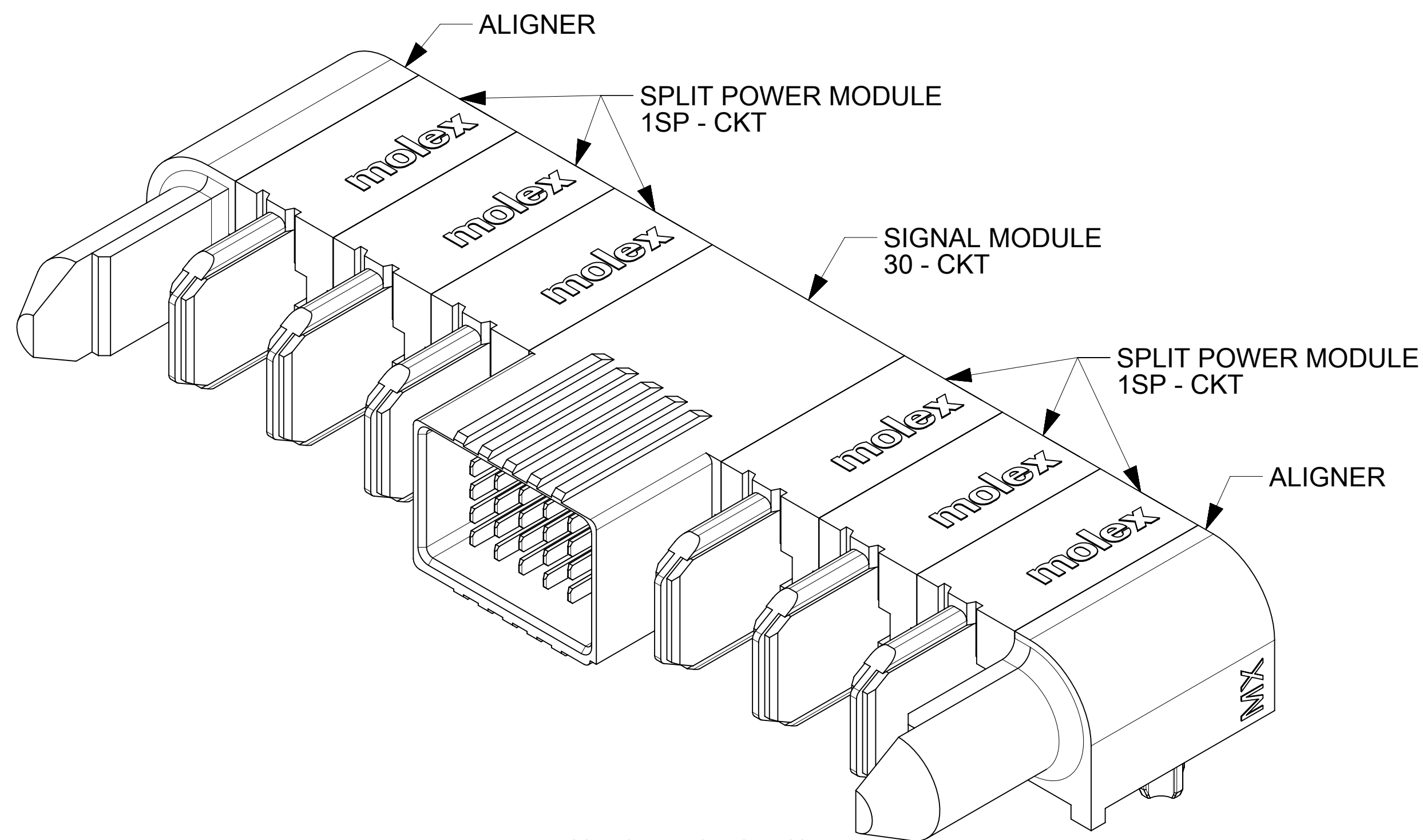

P/N: 171088-8428 (G-3SP-30S-3SP-G)

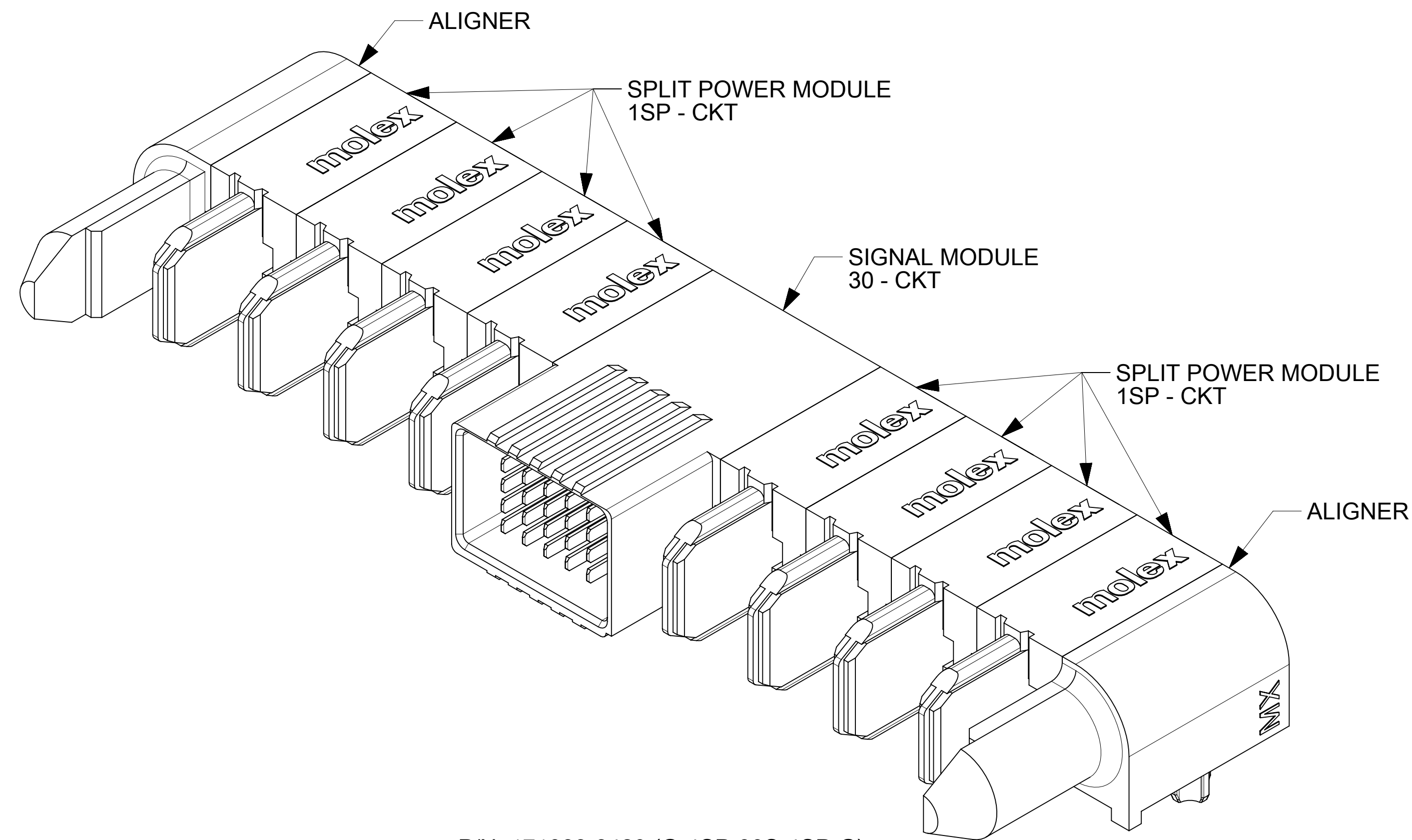

P/N: 171088-8429 (G-4SP-30S-4SP-G)

THIS DRAWING CONTAINS INFORMATION THAT IS PROPRIETARY TO MOLEX ELECTRONIC TECHNOLOGIES, LLC AND SHOULD NOT BE USED WITHOUT WRITTEN PERMISSION												
DIMENSION UNITS		SCALE		CURRENT REV DESC: ADDED ISO VIEWS						molex		
mm		4:1										
GENERAL TOLERANCES (UNLESS SPECIFIED)				EC NO: 689821								
ANGULAR TOL ± 0.5°				DRWN: KSUTAR		2021/12/15		G-*SP-*S-*SP-G				
4 PLACES ±				CHK'D: GJEEVANSURES		2021/12/22		R/A PLUG ASSY - TEN60 SPLIT POWER				
3 PLACES ±				APPR: HTHYAGARAJ		2022/02/14		PRODUCT CUSTOMER DRAWING				
2 PLACES ± 0.13				INITIAL REVISION:				DOCUMENT NUMBER		DOC TYPE	DOC PART	REVISION
1 PLACE ± 0.25				DRWN: KSUTAR		2021/09/23		1710888430		PSD	000	A1
0 PLACES ±				APPR: HTHYAGARAJ		2021/11/08		MATERIAL NUMBER		CUSTOMER	SHEET NUMBER	
DRAFT WHERE APPLICABLE MUST REMAIN WITHIN DIMENSIONS				THIRD ANGLE PROJECTION		DRAWING		SERIES		SEE TABLE		GENERAL MARKET
				D-SIZE		171088						4 OF 4