

DATA SHEET

UVM003A-0302U1-RN1

Precaution



This product, UVC LED assembly, emits deep ultraviolet light.

Do not irradiate the body directly because UVC has a strong influence on cells.

Do not look directly at light. / Avoid direct exposure to skin.

Please be careful of handling of UVC and conduct the driving confirmation based on your judgment.

CITIZEN ELECTRONICS CO., LTD. shall not be liable for any personal or property damage due to deep ultraviolet light.

	 WARNING
	UV LED High intensity ultraviolet light Eye and skin hazard -avoid exposure to eyes/skin Do not look directly at light -use eye protection Use warning labels on systems containing UV LED

DATA SHEET

Ref_CE-0891P-202208

1/13

1. Scope of Application

This datasheet is applied to UVM003A-0302U1-RN1.



2. Part code

UVM 003A - 03 02 U1 - RN1
 [1] [2] [3] [4] [5]

[1] Product name

[2] Die count in series 3

[3] Die count in parallel 2

[4] UVC package U1

[5] Luminous Intensity Distribution Reflector Narrow1 ※1

※1 As for irradiation range, please refer to Effective Irradiation Range of 4. Performance (2)

■ Features ■

- Purpose : disinfection
- LED : UVC LED Peak wavelength 260~270nm ※2
 ※2 Wavelength range of LED to be mounted should be the specification value of the LED manufacturer at Tc=25℃ 500mA
- Outline Drawing : 200×30×40.3mm
- Structure : High-heat dissipation structure on aluminum base
- Compliant with RoHS2.0 Directive and halogen free

△5				
△4				
△3				
△2				
△1				
Mark	Number of mark	Date	Details of change	Drawn by

DATA SHEET

Ref_CE-0891P-202208

2/13

3. Outline drawing and marking (unit: mm)

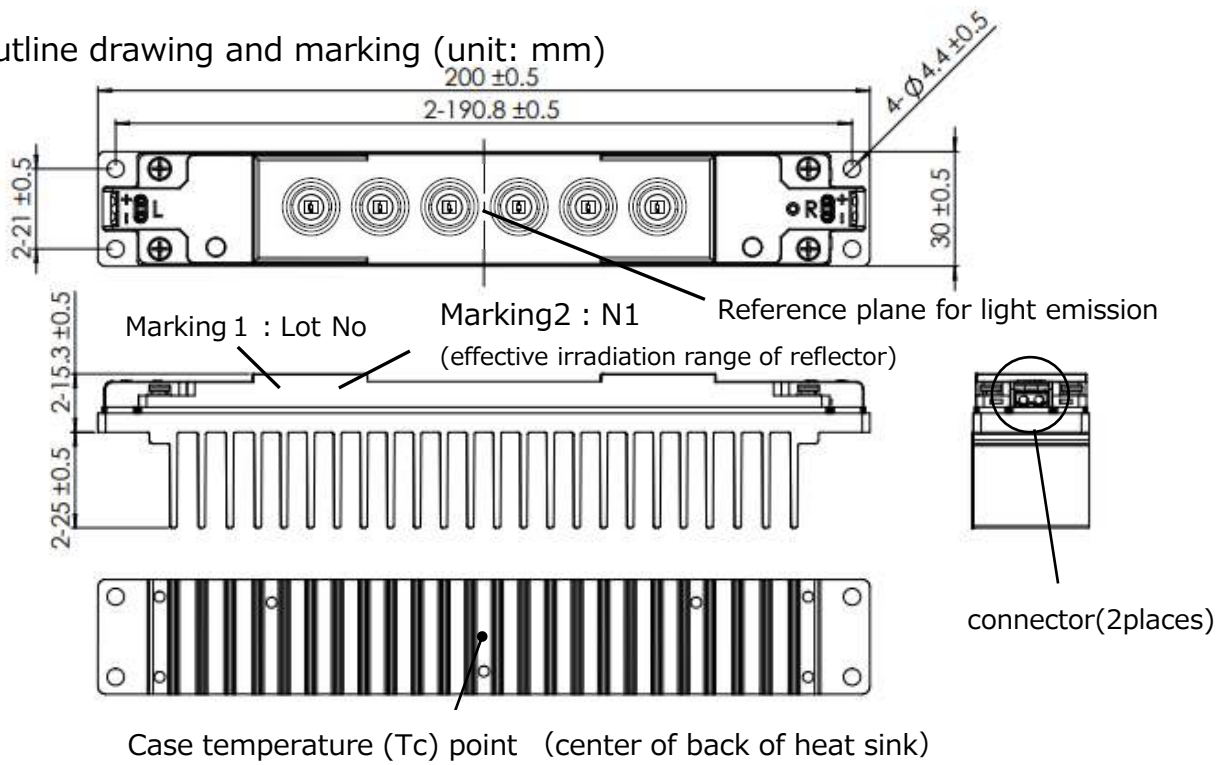

Details of connector

Manufacturer: WAGO
Model no. : 2060-452/998-404

Recommended cable

Cable type	① Stranded wire	0.2~0.75mm ²
	② Single wire	Φ0.5~Φ1.0mm
	③ AWG wire	24-18
Strip length	7~9mm	
Dimension of sheath	Φ1.8 mm以下	

Names of parts

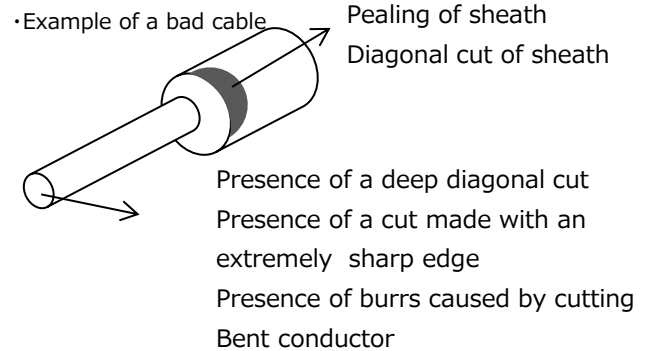
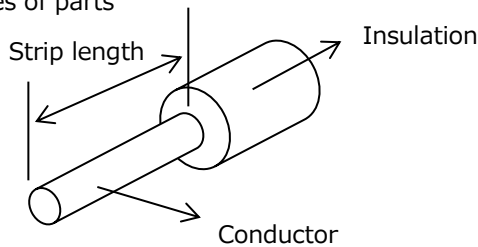

△5				
△4				
△3				
△2				
△1				
Mark	Number of mark	Date	Details of change	Drawn by

DATA SHEET

Ref_CE-0891P-202208

3/13

4. Performance

(1) Absolute Maximum Rating

Parameter	Symbol	Maximum Rating Value	Unit	
Input Power	P _i	13.4	W	*1
Forward Current	I _F	600	mA	*1
Reverse Voltage	V _R	-5	V	
Operating Temperature Range (Ambient temperature)	T _{op}	-10 ~ +45	°C	
Storage Temperature Range	T _{st}	-25 ~ +75	°C	
Case temperature	T _c	70	°C	*2
Tightening Torque	-	0.6	N·m	

*1 Input power, forward current and case temperatures are values for use within the range of the derating curve described in this data sheet.

*2 As for measurement point of case temperature, refer to 3. Outline drawing

(2) UVC LED Assembly Characteristics (Electrical and physical characteristics) T_c=25°C ※1 ※2

Parameter	Symbol	Condition	MIN	TYP	MAX	Unit
Forward Voltage	V _F	I _F =500mA	13.9	-	22.7	V
Central radiant intensity ※3	-	I _F =500mA	0.037	(0.100)	-	mW/cm ²
Ambient irradiance ※4	-	I _F =500mA	0.022	(0.048)	-	mW/cm ²

※1 The measurement distance is 50 cm. (Distance from UVC LED to the light receiving part of the measuring instrumen)

※2 Measurement tolerances: Forward Voltage ±3%, Illuminance ±10%

※3 ※4 For Central radiant intensity and ambient irradiance, please refer to below figures

UVM003A-0302U1-RN1

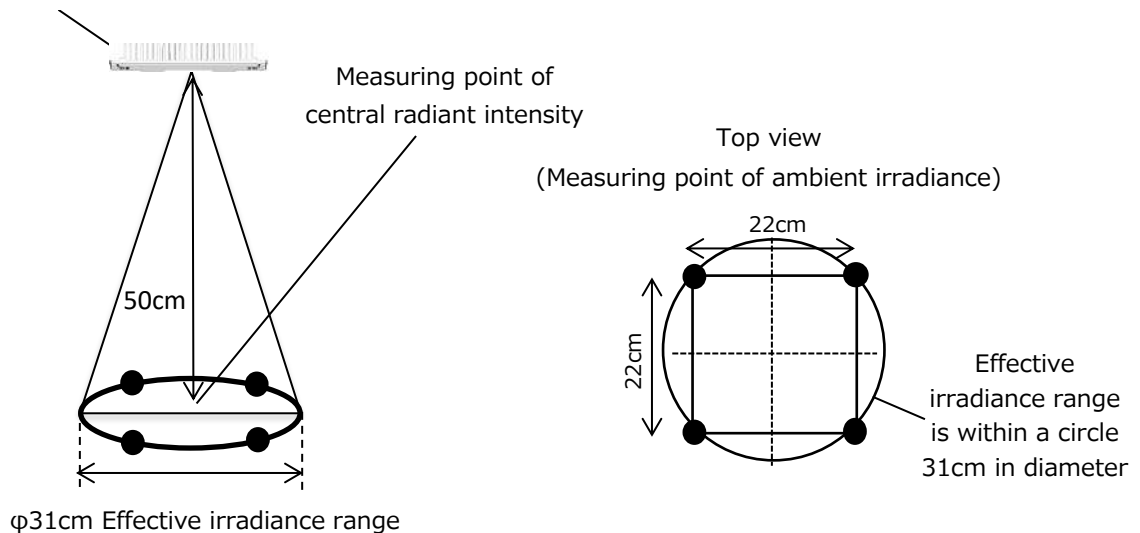

△5				
△4				
△3				
△2				
△1				
Mark	Number of mark	Date	Details of change	Drawn by

CITIZEN ELECTRONICS CO., LTD.

DATA SHEET

Ref_CE-0891P-202208

4/13

(3) Circuit diagram

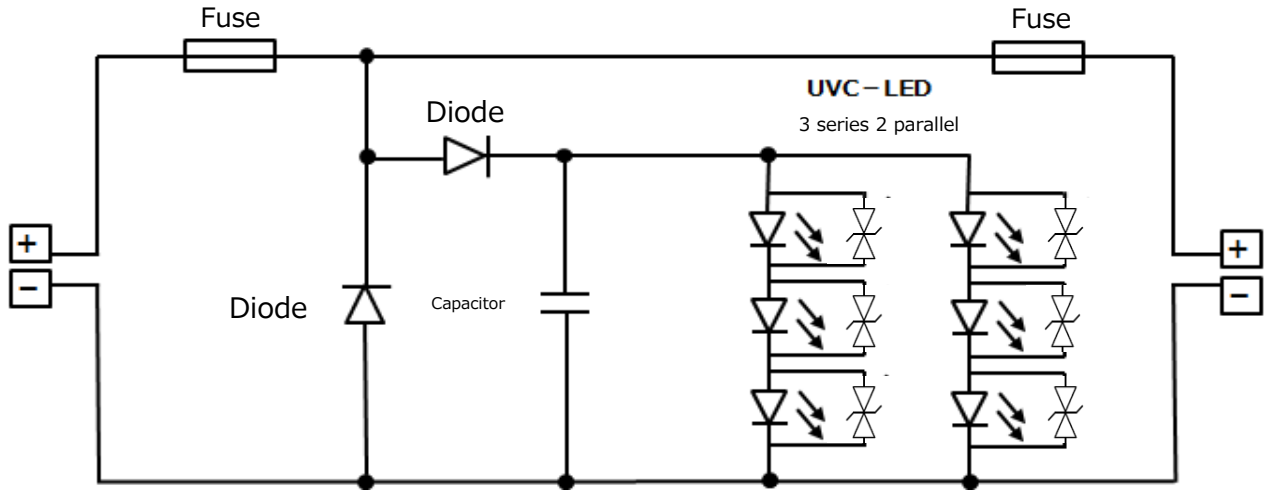

• Recommended connection

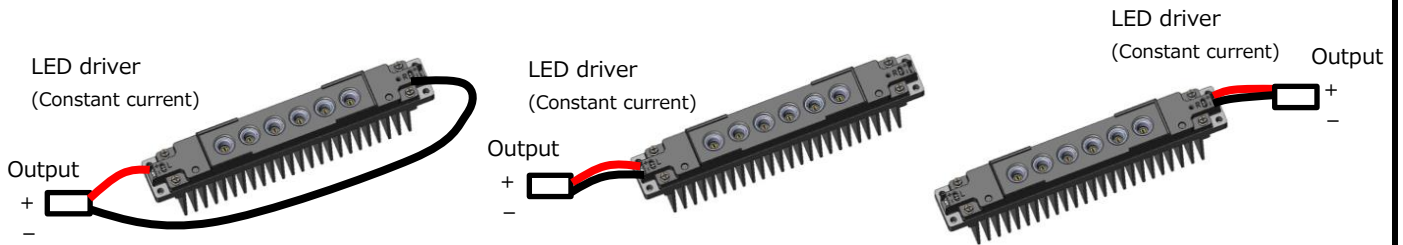

△5				
△4				
△3				
△2				
△1				
Mark	Number of mark	Date	Details of change	Drawn by

DATA SHEET

Ref_CE-0891P-202208

5/13

5. Various Characteristics

◆ Forward Current – Forward Voltage Characteristics

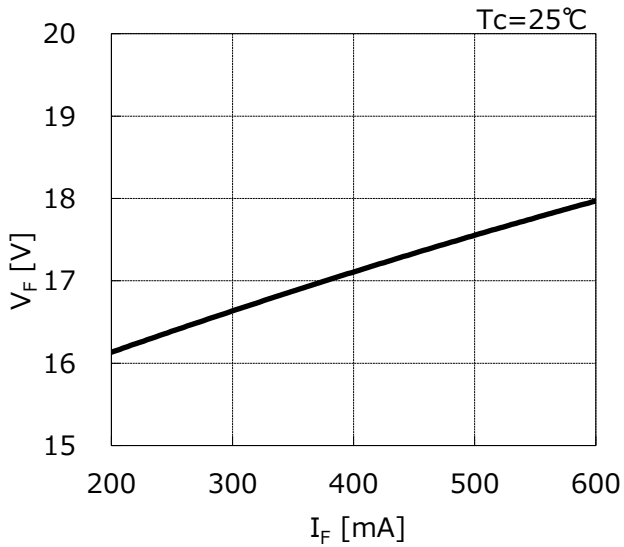

◆ Forward Current – Relative Central radiant intensity Characteristics

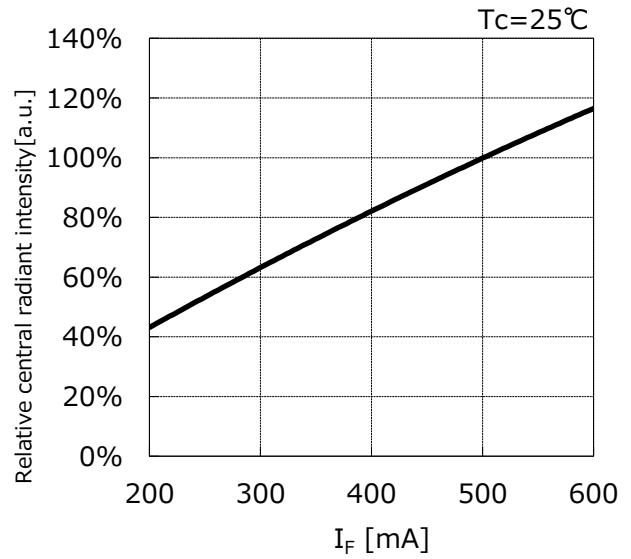

◆ T_c Temperature – Forward Voltage Characteristics
I_F= 500mA

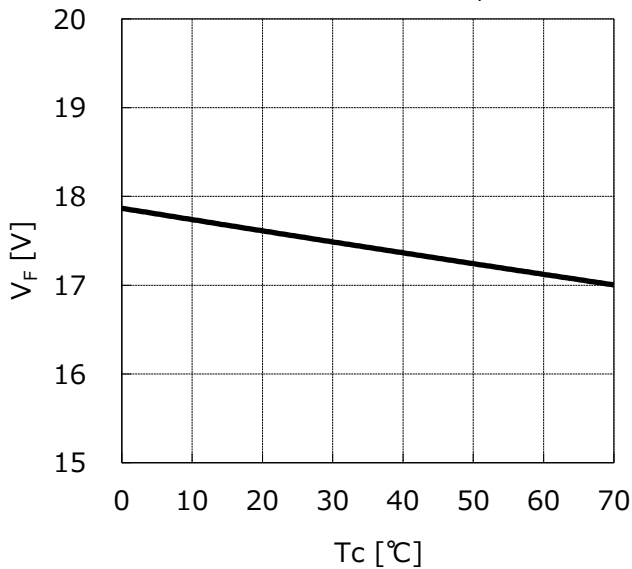

◆ T_c Temperature – Relative Central radiant intensity
I_F= 500mA

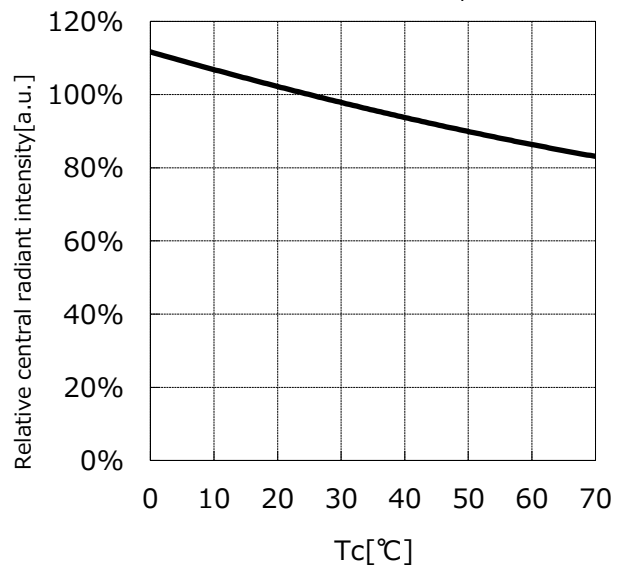

△5				
△4				
△3				
△2				
△1				
Mark	Number of mark	Date	Details of change	Drawn by

DATA SHEET

Ref_CE-0891P-202208

6/13

◆ Tc Temperature – Forward Current Rating

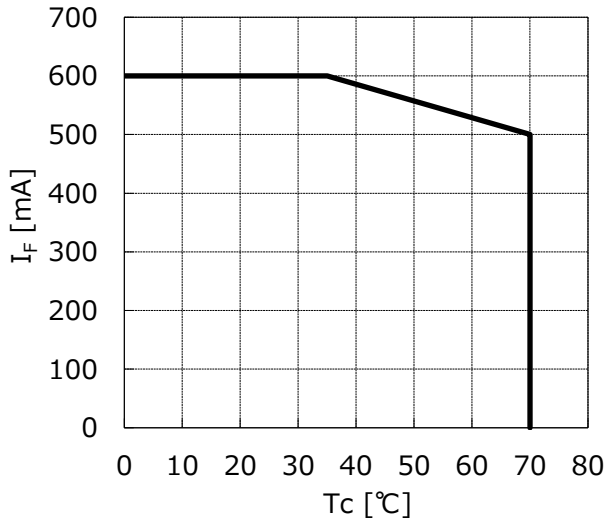

◆ Emission spectrum

Reference value of LED to be mounted Tc=25°C
If=500mA

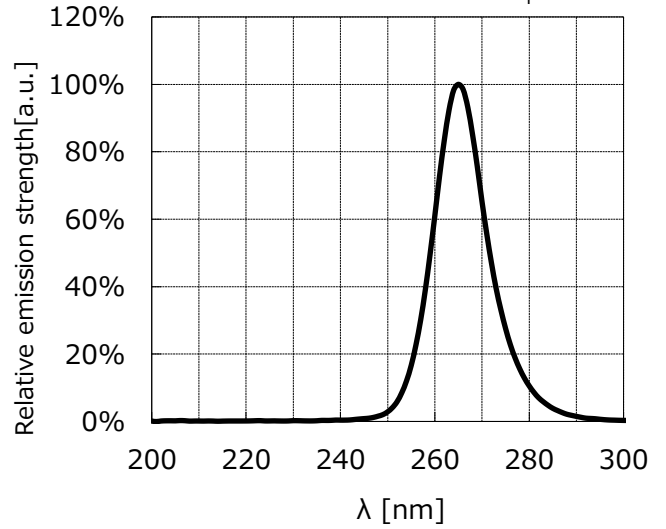

△5				
△4				
△3				
△2				
△1				
Mark	Number of mark	Date	Details of change	Drawn by

DATA SHEET

Ref_CE-0891P-202208

7/13

6. Reliability

(1) Details of the Tests

Test item	Test conditions	Test hours
①Continuous Operation	$I_F=500\text{mA}(250\text{mA}/\text{LED})$ $T_a=25^\circ\text{C}$ $T_c=35^\circ\text{C}$	500 hours
②High Temperature and High Humidity Operation Test	$I_F=500\text{mA}(250\text{mA}/\text{LED})$ $T_a=45^\circ\text{C}$ $T_c=55^\circ\text{C}$ 95%	500 hours
③Low Temperature Storage Test	$T_a=-25^\circ\text{C}$	500 hours
④High Temperature Storage Test	$T_a=75^\circ\text{C}$	500 hours
⑤High Temperature and High Humidity Storage Test	$T_a=45^\circ\text{C}$ 95%	500 hours
⑥Temperature Cycle Test	$T_a=-25^\circ\text{C}(30\text{min})\sim 75^\circ\text{C}(30\text{min})$ one cycles	100 cycles
⑦Withstand Voltage Test	AC500V is applied between heat sink and connector	1 minute

Note) T_a means ambient temperature

(2) Judgment Criteria of Failure for Reliability Test (①~⑥)

($T_a=25^\circ\text{C}$)

Measuring Item	Symbol	Measuring Condition	Judgement Criteria for Failure
Forward Voltage	V_F	$I_F= 500\text{mA}$	$>U \times 1.1$
Irradiance	mW/cm^2	$I_F= 500\text{mA}$	$<S \times 0.50$

U : means the upper limit of the specified characteristics. S : means the initial value.

Note) Measurement shall be taken between 2 hours and 48 hours, having returned the test pieces to the normal ambient conditions after the completion of each test.

(3) Judgment Criteria of Failure for Reliability Test (⑦)

- No dielectric breakdown should occur when voltage is applied
- No dielectric breakdown or damage to the appearance of substrate or housing should occur.

△5				
△4				
△3				
△2				
△1				
Mark	Number of mark	Date	Details of change	Drawn by

CITIZEN ELECTRONICS CO., LTD.

DATA SHEET

Ref_CE-0891P-202208

8/13

7. Packing specifications

Stack four trays with five products each and place one tray without products on the top

(Minimum packing quantity is 20 pieces)

Foam tray (size : 280 x 260 x 58mm, material : polyethylene foam)

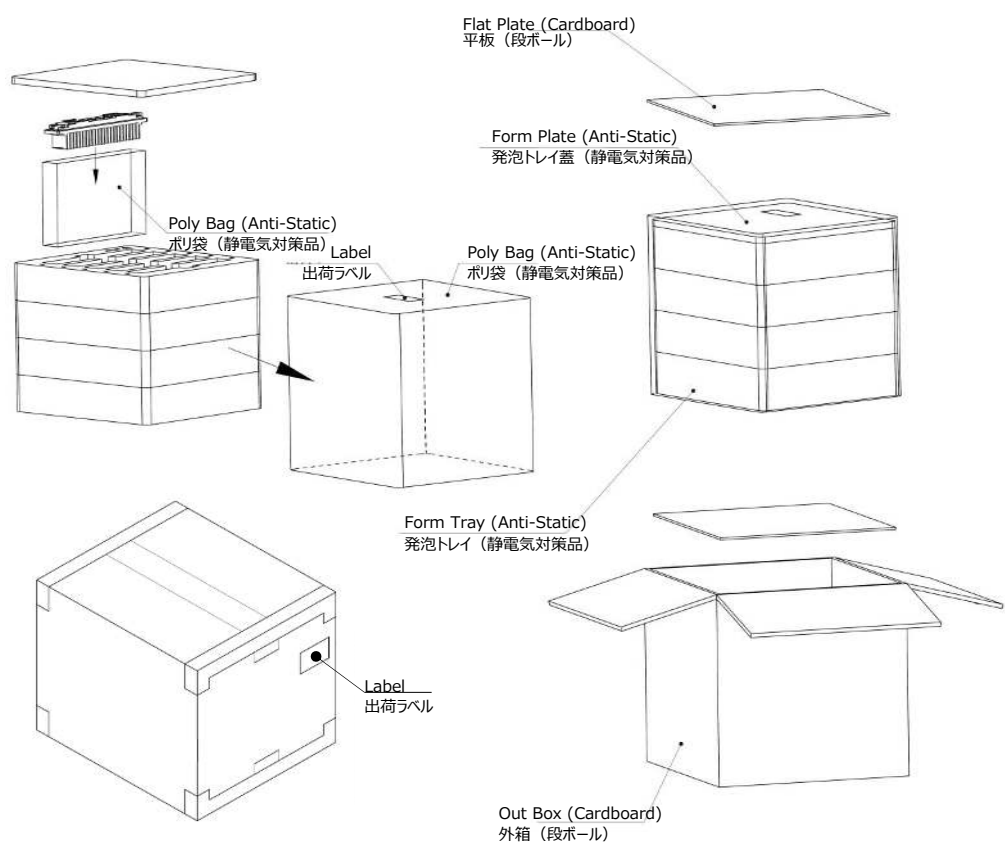
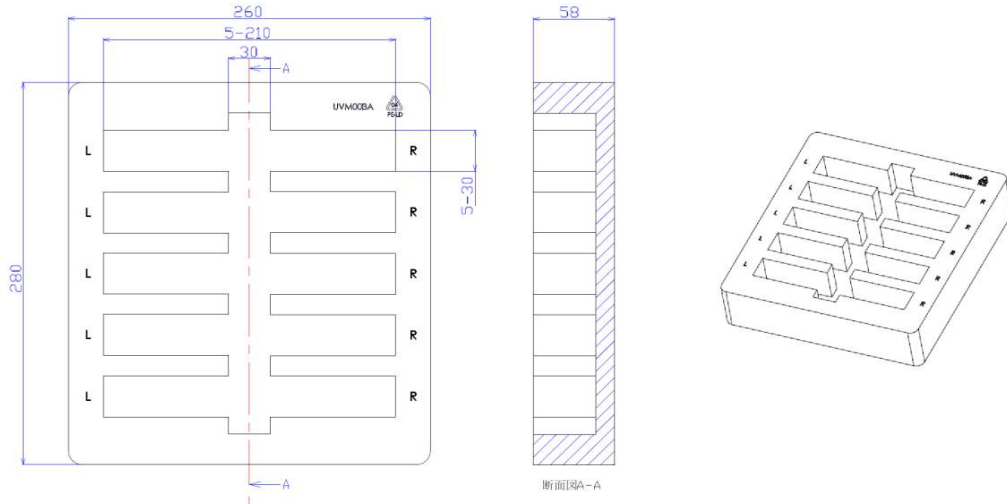

△5				
△4				
△3				
△2				
△1				
Mark	Number of mark	Date	Details of change	Drawn by

DATA SHEET

Ref_CE-0891P-202208

9/13

8. Precautions

(1) Handling precautions

- This product is a product that emits deep ultraviolet rays (UVC).
UVC has a strong influence on cells, so direct exposure to the body is dangerous.

- JISZ8812 defines the allowable amount of ultraviolet rays, which is 4.6 mJ / cm² (8 hours a day) for 260 nm and 3mJ / cm² (8 hours a day) for 270 nm.
Do not look at UVC lighting directly because there is a risk of eye pain or visual impairment.
Irradiating the skin directly with UVC light may cause skin irritation.
Please take measures such as using protective glasses or gloves to prevent direct exposure of ultraviolet rays to the human body.
Also, pay attention not only to the direct light itself but also to reflected light.

- Ultraviolet rays are also irradiated outside the effective irradiance range described in 4. Performance.

- Ultraviolet rays deteriorate wallpaper or resin products, etc. Also, if you irradiate at a short distance, the color of such may change rapidly. Please be careful regarding deterioration and discoloration of the object exposed to light.

- Plants are sensitive to UV light. Depending on the type of plant, the leaves may wilt or die.

- We are not liable for any personal or property damage caused to you or a third party due to UV exposure.

- Please do not touch the glass area because it is an optical product and such contact impacts on the function, performance and reliability of the product.
Do not touch the glass area or its surroundings during or immediately after irradiation as they may be hot.

- Please do not apply stress to the product by swinging or pulling the lead.

- Do not add excessive shock by a dropping and so on. It may cause a malfunction or an unexpected accident.

- Covering or sealing the product may cause heat to build up inside and it may cause a fire or malfunction.

- Disassembling or modifying the product may cause a part to drop off, fire, electric shock, or injury.

- If you connect or disconnect the power supply line or operate the product with wet hands, you may receive an electric shock.

- If you notice a strange odor or smoke, cease operation it immediately. It may cause a fire or electric shock.

- Do not use for any purpose other than sterilization.

△5				
△4				
△3				
△2				
△1				
Mark	Number of mark	Date	Details of change	Drawn by

CITIZEN ELECTRONICS CO., LTD.

DATA SHEET

Ref_CE-0891P-202208

10/13

(2) Precautions for fixing the product

- We recommend fixing UVC LED Assbembly by using M4 screws.
Please attach the UVC LED Assembly by temporarily tightening screws and then conducting final tightening of the screws to prevent the application of an excessive stress or strain on the UVC LED Assembly.

- When using the product while it is adhered to something or while connected to another component constituting one body, make sure to confirm that the quality of the product is not affected by way of an appropriate method.

(3) Countermeasure against static electricity

- Handling of this product requires countermeasures against static electricity because it is a semiconductor product. Please take adequate measures to prevent any static electricity being produced such as by wearing of a wristband or antistatic gloves.

- Every manufacturing facility concerned with the product (plant, equipment, machine, carrier machine and conveyance unit) should be grounded to prevent the product from being electric-charged.

- After assembling the UVC LED assembly into your final product(s), it is recommended to check whether the assembled UVC LED assembly have been damaged by static electricity (electrical leak phenomenon) or not.

(4) LED driving conditions

- It is recommended to drive the UVC LED assembly by using constant current.

- Please ensure no excessive current, excessive voltage or excessive reverse voltage electrical transients is applied to the UVC LED assembly when turning ON or OFF the UVC LED assembly.

- Ensure the power supply system of this product is separate from lighting equipment and other equipment.

△5				
△4				
△3				
△2				
△1				
Mark	Number of mark	Date	Details of change	Drawn by

CITIZEN ELECTRONICS CO., LTD.

DATA SHEET

Ref_CE-0891P-202208

11/13

(5) Operating environment and storage

- This product is not designed for usage under the following conditions.

If the product is used or may be used in the following environments, you must take appropriate measures and evaluate the effect before use.

Places where the product is or may:

- be directly or indirectly wet with rain or splash

- be damaged by sea breeze or salt

- be exposed to corrosive gas (such as Cl₂, H₂S, NH₃, SO_x, NO_x, etc.)

- be exposed to dust, fluid or oil

- Do not use or store the product under conditions where chlorine, sulfur, acid or alkaline gas, or salt which is compressed or condensed is present, or where factors that generate corrosion exist.

- Please store the product at ambient temperature between 5 to 40°C and at RH between 20 to 70%.
Please keep the product away from direct sunlight and dust.

△5				
△4				
△3				
△2				
△1				
Mark	Number of mark	Date	Details of change	Drawn by

DATA SHEET

Ref_CE-0891P-202208

12/13

9. Other precautions

- Warranty period is half a year from the day we delivered the product (under the storage conditions we specify.)
- We guarantee the delivered products themselves within the reliability test result items and the conditions. In cases where the product is used in situations outside the conditions described in this delivery specification and such causes an accident or damage, we will not be held liable.
- The absolute maximum ratings of this product are also applied when assembling the product in the actual device. Please confirm service life and quality of the product in the assembled device and in practical use at your company. Also, please sufficiently verify conformance to the standards such as safety and reliability and assurance of performance of the final product on your own responsibility.
- If any defect is found during the warranty period, do not disassemble or dismantle the product but contact our sales window to follow its instruction.
- If a defective product is found, we will take measures with mutual consultation, but if it is clear that the defective product should be attributed to CE, we will deliver a replacement product in principle.
- Our warranty does not cover situations where this product undergoes secondary fabrication such as change in shape.
- Do not reverse-engineer the product including disassembling or analysis without our approval.
- This product is intended to be used for general electronic equipment such as general lighting, home appliances, and information-communication equipment. It is not designed or manufactured to be used for special application (eg. automobiles, trains, ships, airplanes, spaceships, submarine repeaters, atomic energy control systems, combustion equipment, life-support systems, safety devices). We will not guarantee any application suitability for goods like those described above that require special quality and reliability. In cases where the product is used in special applications and it causes an extensive property damage, threatens human life or damages the human body, we will not be held liable.
- We will not be liable for any disadvantage, damage or cause of legal action, or any other damage or loss that arise from the use or nonuse of technical information or data of this specification.
- When designing as a set where safety is important, make sure to consider the impact that a malfunction of a single product has on the whole set, and ensure safety with a fail-safe design such as using a protection circuit or a protection device.

△5				
△4				
△3				
△2				
△1				
Mark	Number of mark	Date	Details of change	Drawn by

CITIZEN ELECTRONICS CO., LTD.

DATA SHEET

Ref_CE-0891P-202208

13/13

- This technical information and data is provided for users as is, and Citizen Electronics Co., Ltd. does not guarantee that it is free from errors or defect in technical information and data, or this technical information and data conform to special applications, or this technical information and data does not infringe any rights of the user or third parties other than the user, or any other contents thereof.
- Citizen Electronics Co., Ltd. reserves a right to modify technical information and data without notice.
- Customers in Japan are requested to ensure compliance with domestic laws and regulations such as the Foreign Exchange Law when exporting this product, and as for customers in countries or areas outside of Japan, please ensure compliance with the applicable laws and regulations of the location, and take appropriate action(s) such as obtaining an export license.
- Please do not use or supply this product for any weapons of mass destruction (WMD) or for any other military purposes.
- This data sheet constitutes the entire agreement between Citizen Electronics and your company as to the matters regarding the product, and any prior agreement that was made before the receipt of the data sheet and that is not specified in the data sheet will cease to have effect.
- The contents of this document are not guaranteed because the specification and appearance of the product may change without notice for improvement. Please exchange formal specifications with us prior to use for mass production.

Information in this document (text, photos or images) is subject to copyright and is protected by law. It is prohibited by law to reproduce or reprint the information without approval of Citizen Electronics except for "reproduction for private use" or for "quotes."

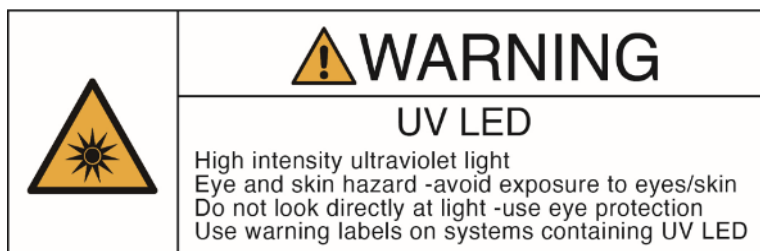

△5				
△4				
△3				
△2				
△1				
Mark	Number of mark	Date	Details of change	Drawn by

CITIZEN ELECTRONICS CO., LTD.