

**TORQUE SETTING**

6.1-9.5 in-lbs [7-11 kgf-cm]

**MATERIAL & FINISH**

BACKSHELL: ABS - UL HB RATED - BLACK  
 BUSHING & BAFFLE: SILICONE  
 THUMBSCREWS: NICKEL PLATED BRASS  
 OPERATION TEMPERATURE: 0°C TO 80°C (BASED ON ABS)  
 CABLE DIAMETER: 0.350 in [8.89mm] MAX  
 0.130 in [3.30mm] MIN

**MATING PARAMETERS:**

RECOMMENDED MAX TORQUE: 40 in-oz  
 NOMINAL GASKET COMPRESSION: 0.055"

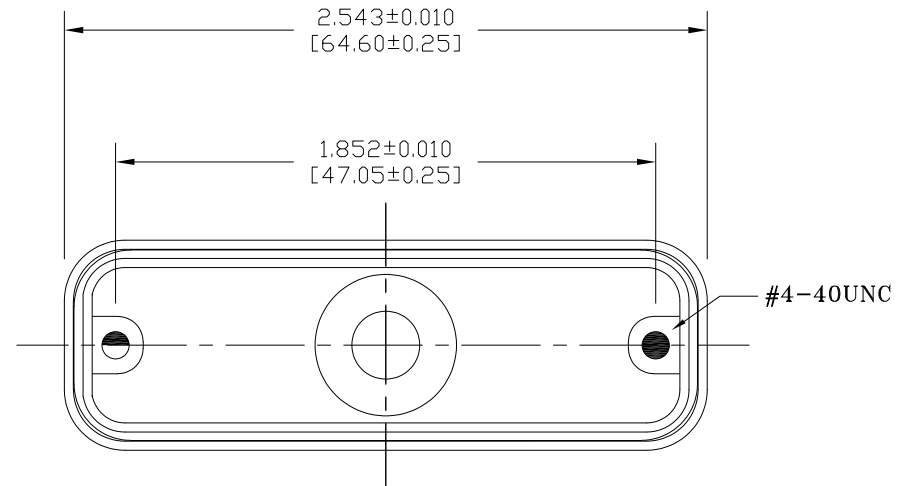

**RoHS COMPLIANT**



THESE DRAWINGS AND SPECIFICATIONS ARE THE PROPERTY OF NorComp AND SHALL NOT BE REPRODUCED, COPIED OR USED AS THE BASIS FOR THE MANUFACTURE OR SALE OF APPARATUS WITHOUT WRITTEN PERMISSION.

DRAWN:  
M. SIGMON

DATE:  
12/15/2010

UNITS = inch [mm]

**DO NOT SCALE FROM DRAWING**

**NorComp**

SCALE:  
NTS

SHEET 1 OF 1

REV 8

DWG NO.

967-025-010R011