

# XCKD25H0G11

Limit switch, Limit switches XC Standard, XCKD, M18 metal end plunger, 1NC+1 NO, slow, Pg11



## Main

Range of Product	Telemecanique Limit switches XC Standard
Series name	Standard format
Product or Component Type	Limit switch
Device short name	XCKD
Sensor design	Compact
Body type	Fixed
Head type	M18 plunger head
Material	Metal
Body Material	Zamak
Head material	Zamak
Fixing Mode	By the head
Movement of operating head	Linear
Type of operator	Spring return plunger metal
Type of approach	Vertical approach, 1 direction
Number of poles	2
Contacts type and composition	1 NC + 1 NO
Contact operation	Slow-break, break before make

## Complementary

Switch actuation	On end
Electrical connection	Screw-clamp terminals 1 x 0.5...2 x 2.5 mm <sup>2</sup>
Cable entry	1 entry tapped for Pg 11 cable gland
Contacts insulation form	Zb
Positive opening	With
Positive opening minimum force	45 N
Minimum force for tripping	15 N
Minimum actuation speed	6 m/min
Maximum actuation speed	1.64 ft/s (0.5 m/s)
Repeat accuracy	0.1 mm on the tripping points with 1 million operating cycles
Contact code designation	A300, AC-15 (Ue = 240 V), Ie = 3 A 10 A EN 60947-5-1 A300, AC-15 (Ue = 240 V), Ie = 3 A 10 A IEC 60947-5-1 appendix A Q300, DC-13 (Ue = 250 V), Ie = 0.27 A EN 60947-5-1 Q300, DC-13 (Ue = 250 V), Ie = 0.27 A IEC 60947-5-1 appendix A
[Ui] rated insulation voltage	300 VUL 508 500 V 3)IEC 60947-1 300 VCSA C22.2 No 14
Maximum resistance across terminals	25 MOhm IEC 60255-7 category 3
[Uimp] rated impulse withstand voltage	6 KV IEC 60664 6 kV IEC 60947-1
Short-circuit protection	10 A cartridge fuse gG
Electrical durability	5000000 Cycles, DC-13, 120 V, 7 W 60 cyc/mn 0.5 IEC 60947-5-1 appendix C 5000000 Cycles, DC-13, 24 V, 13 W 60 cyc/mn 0.5 IEC 60947-5-1 appendix C 5000000 cycles, DC-13, 48 V, 9 W 60 cyc/mn 0.5 IEC 60947-5-1 appendix C
Mechanical durability	10000000 cycles
Width	1.22 in (31 mm)
Height	2.56 in (65 mm)

Depth	1.18 in (30 mm)
Net Weight	0.49 lb(US) (0.22 kg)
Terminals description ISO n°1	(13-14)NO (21-22)NC

## Environment

Shock resistance	50 gn 11 ms IEC 60068-2-27
Vibration resistance	25 gn 10...500 Hz)IEC 60068-2-6
IP degree of protection	IP66IEC 60529 IP67IEC 60529
IK degree of protection	IK06 EN 50102
Electrical shock protection class	Class I IEC 61140 Class I NF C 20-030
Ambient Air Temperature for Operation	-13...158 °F (-25...70 °C)
Ambient Air Temperature for Storage	-40...158 °F (-40...70 °C)
Protective treatment	TC
Product Certifications	UL CSA CCC
Standards	UL 508 CSA C22.2 No 14 IEC 60204-1 IEC 60947-5-1 EN 60204-1 EN 60947-5-1





## Ordering and shipping details

Category	22418-LIMIT SWITCH,IEC,XCKP&XCKT
Discount Schedule	T
GTIN	3389110312256
Nbr. of units in pkg.	1
Package weight(Lbs)	7.83 oz (222.0 g)
Returnability	No
Country of origin	ID

## Packing Units

Unit Type of Package 1	PCE
Package 1 Height	3.74 in (9.5 cm)
Package 1 width	1.26 in (3.2 cm)
Package 1 Length	1.50 in (3.8 cm)

## Offer Sustainability

Sustainable offer status	Green Premium product
California proposition 65	WARNING: This product can expose you to chemicals including: Diisononyl phthalate (DINP), which is known to the State of California to cause cancer, and Di-isodecyl phthalate (DIDP), which is known to the State of California to cause birth defects or other reproductive harm. For more information go to <a href="http://www.P65Warnings.ca.gov">www.P65Warnings.ca.gov</a>
REACH Regulation	 <a href="#">REACH Declaration</a>
EU RoHS Directive	Pro-active compliance (Product out of EU RoHS legal scope)  <a href="#">EU RoHS Declaration</a>
Mercury free	Yes
RoHS exemption information	 <a href="#">Yes</a>
Environmental Disclosure	 <a href="#">Product Environmental Profile</a>

## Contractual warranty

Warranty	18 months
----------	-----------

Dimensions

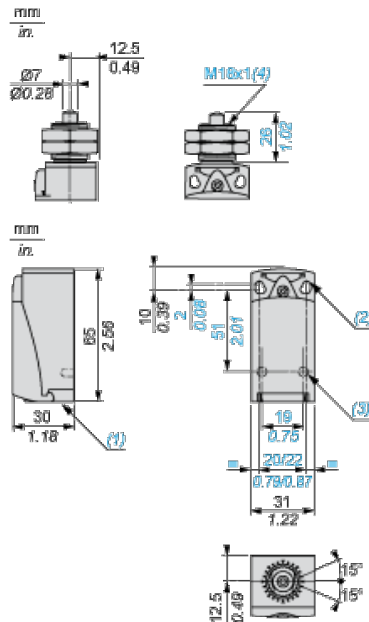

- (1) Tapped entry for Pg 11 cable gland
- (2) 2 elongated holes Ø 4.3 x 6.3 mm on 22 mm centres, 2 holes Ø 4.3 on 20 mm centres.
- (3) 2 x Ø 3 holes for support studs, depth 4 mm.
- (4) Fixing nut thickness 3.5 mm.

---

## Mounting with Cable Entry

---

### Position of Cable Gland

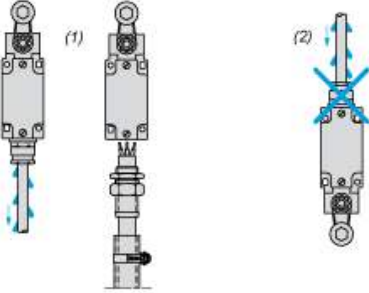

- (1) Recommended
- (2) To be avoided

---

## Panel Mounting

---

### Mounting and Fixing Limit Switches by the Head



- (1) Recommended
- (2) Forbidden

---

## Setting-up

---

### Plunger or Multi-directional Heads

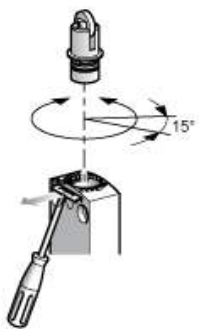

---

Wiring Diagram

---

2-pole NC + NO Break before Make, Slow Break

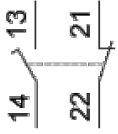

---

Characteristics of Actuation

---

Switch Actuation on End

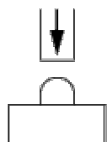

---

Functionnal Diagram

---

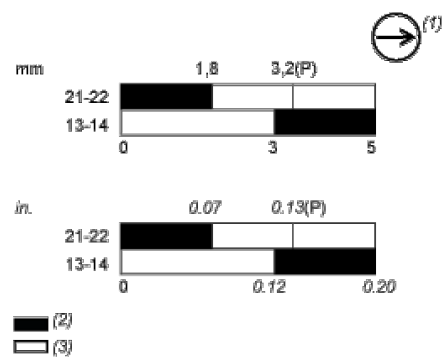

- (P) Positive opening point
- (1) NC contact with positive opening operation
- (2) Closed
- (3) Open