

Steward

Advanced Ferrite Materials, EMI Suppression, and Inductive Products

Home • Ferrite Product Lines • New Products • Technical • General • Contact • Steward Sales

28R2240-130

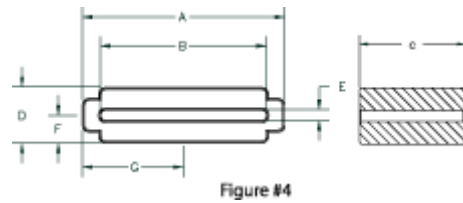
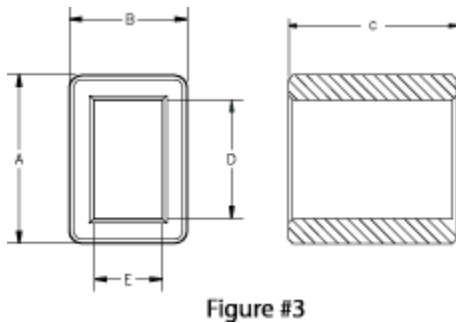
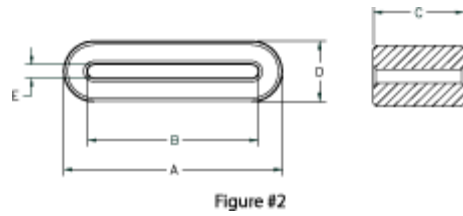
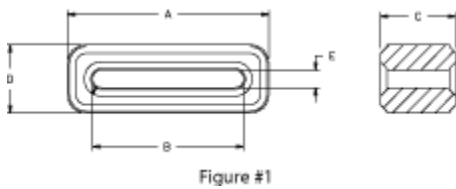

Drawing Figure

Figure Number
2

Electrical Characteristics

Z @ 25 MHz	Z @ 100 MHz	Z @ 300 MHz
40	110	260

Physical Dimensions

A in	A mm	B in	B mm	C in	C mm	D in	D mm	E in	E mm
2.240	56.90	2.060	52.32	0.354	9.00	0.220	5.59	0.040	1.02

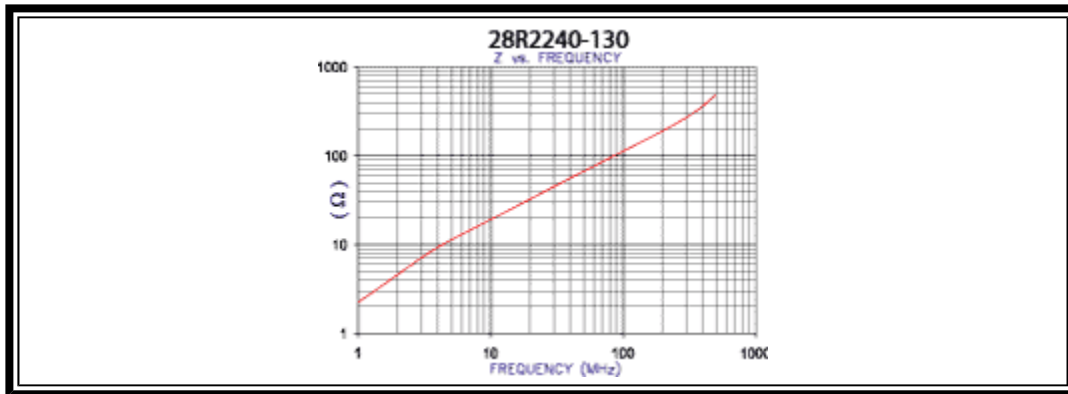

Specifications, which provide more details for the correct use of the described products, are available upon request. All specifications are subject to change without notice. For more information on any of the products listed above, please contact Steward customer service department at (800) 634-2673.

americas@steward.com

mexico@steward.com

europa@steward.com

asia@steward.com

Copyright© 2004 Steward, Inc.

Last Updated: 2/10/2004