

1

2

3

4

5

TECHNICAL CHARACTERISTICS

MATERIAL
 INSULATOR: ABS
 FLAMABILITY RATING: UL94-HB
 COLOR: BLACK
 SCREW: UNC 4-40

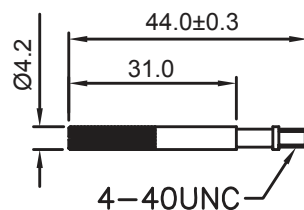
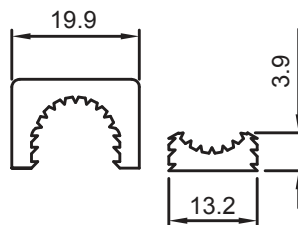
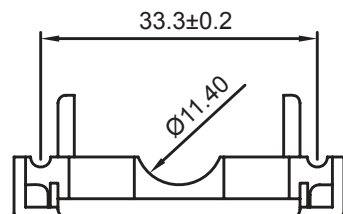
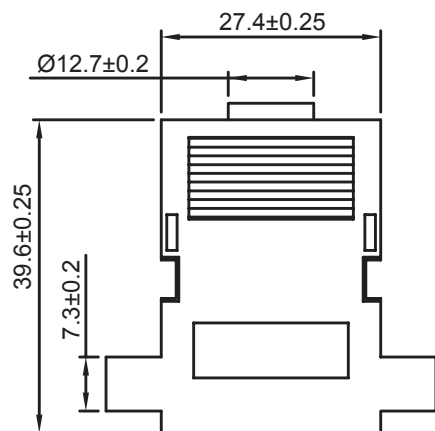
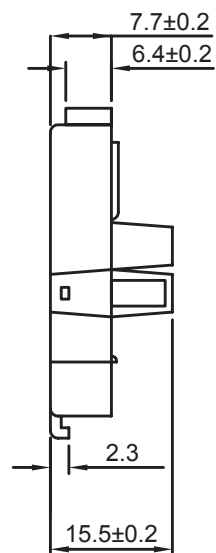

ENVIRONMENTAL
 COMPLIANCE: LEAD FREE AND ROHS

PACKAGING: BAG

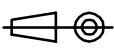

2 PCS

RoHS Compliant

G	17-NOV-14	PACKAGING	AS	PROJECTION: 	GENERAL TOLERANCE .X = +/- 0.2 .XX = +/- 0.15		
F	25-SEP-14	DRAWING+VIEWS	AS				
E	09-APR-13	MEASURE	AR				
D	20-MAR-13	FLAMABILITY	AR				
C	12-NOV-08	CHARACTERISTICS	JP	APPROVAL: NPR	UNIT: MM	DESCRIPTION: WR-DSUB - PLASTIC HOOD SMALL TOP ENTRY 4640 SCREW	SIZE
B	31-MAR-04				SCALE:	WERI PART NO: 618 015 214 622	A4
A	24-AUG-01	PDF	JP		SHEET: 1/3		
REV	DATE	FILE	BY		DRAW: AS		

A

B

C

D

1

2

3

4

5

A

B

C

D

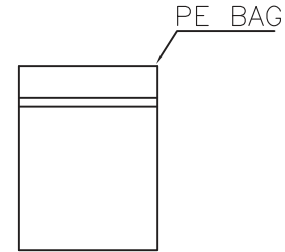
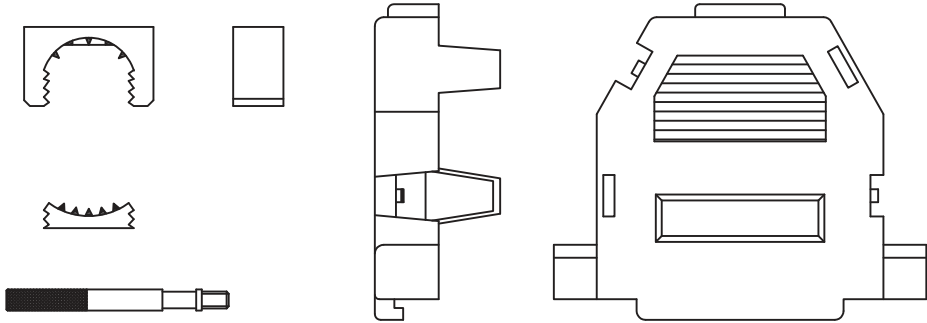
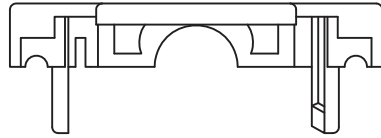

50 Pcs/Bag
6 Bags/Carton
300 Pcs/Carton

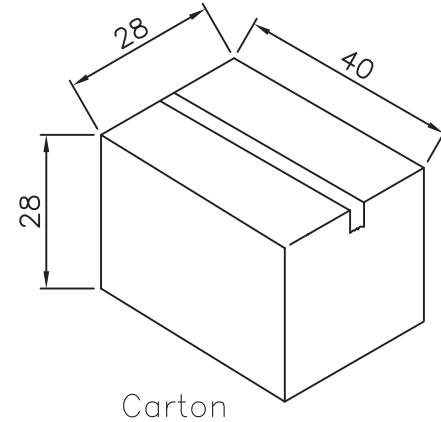

Carton

RoHS Compliant			
G			
F			
E			
D			
C			
B			
A	17-NOV-14	PDF	AS
REV	DATE	FILE	BY

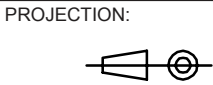

APPROVAL: NPr

GENERAL TOLERANCE
.X = +/- 0.2
.XX = +/- 0.15

UNIT: MM
SCALE:
SHEET: 2/3
DRAW: AS



DESCRIPTION: WR-DSUB - PLASTIC HOOD SMALL TOP ENTRY 4640 SCREW
WERI PART NO: 618 015 214 622

SIZE
A4

