



FocusLCDs.com
LCDs MADE SIMPLE®

Ph. 480-503-4295 | NOPP@FocusLCD.com

TFT | CHARACTER | UWVD | FSC | SEGMENT | CUSTOM | REPLACEMENT

TFT Display Module

Part Number

E30RB-I-MW320-C

Overview:

- 3.0-inch TFT (48.14x83.50 I I)
- 360° 640 x 480
- 2-lane MIPI DSI Interface
- 0° 0.1mm
- All View
- Transmissive, IPS
- Capacitive Touch Panel
- 320 nits
- TFT IC: ST7701S
- RoHS Compliant

Description

This is a color active matrix TFT (Thin Film Transistor) LCD (Liquid Crystal Display) that uses amorphous silicon TFT as a switching device. This model is composed of a transmissive type TFT LCD Panel, driver circuit, capacitive touch panel and a backlight unit. The resolution of the 3.0" TFT LCD contains 360(RGB)x640 pixels and can display up to 16.7M colors.

TFT Features

Low Input Voltage: 3.3V

Display Colors: 16.7M

Interface: 2-lane MIPI DSI

General Information Items	Specification	Unit	Note
	Main Panel		
TFT Display area (AA)	36.72(H) x 65.28(V) (3.0 inch)	mm	-
Driver Element	TFT active matrix	-	-
Display Colors	16.7M	colors	-
Number of pixels	360(RGB)x640	pixels	-
TFT Pixel arrangement	RGB vertical stripe	-	-
Pixel Pitch	0.102(H)x0.102(V)	mm	-
Viewing angle	All	o'clock	-
TFT Controller IC	ST7701S	-	-
TFT Interface	2-lane MIPI	-	-
Display mode	Transmissive/ Normally Black	-	-
Operating temperature	-20-+70	°C	-
Storage temperature	-30-+80	°C	-
CTP Controller	FT5436	-	-
CTP Interface	I2C	-	-
Touch Mode	Multipoint and gesture	-	-
Module Bonding	COF/SCA Bonding	-	-

Mechanical Information

Item		Min	Typ.	Max	Unit	Note
Module Size	Horizontal (H)		48.14		mm	-
	Vertical (V)		83.50		mm	-
	Depth (D)		3.82		mm	-
	Weight		23		g	

1. Outline Dimensions

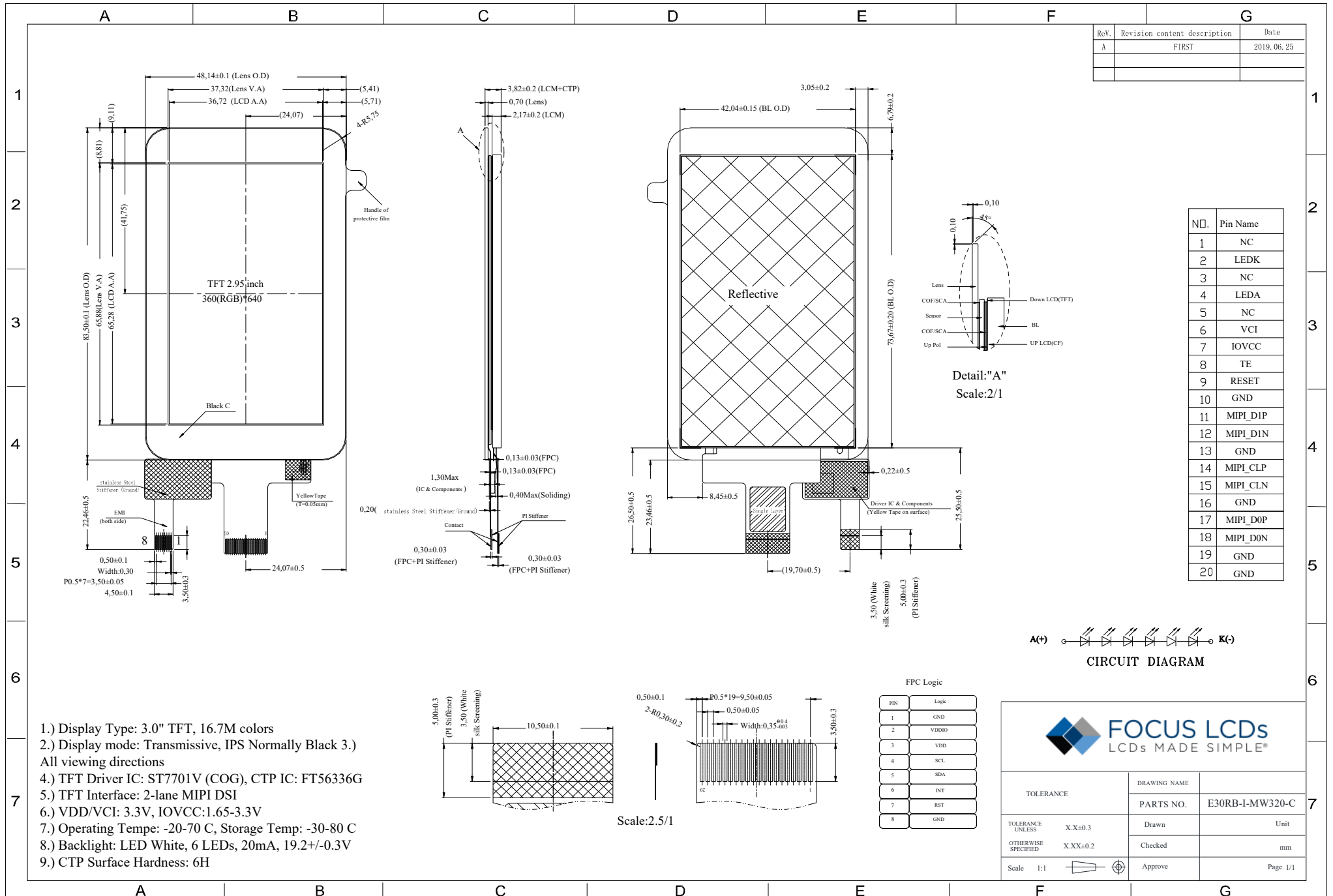

2. Block Diagram

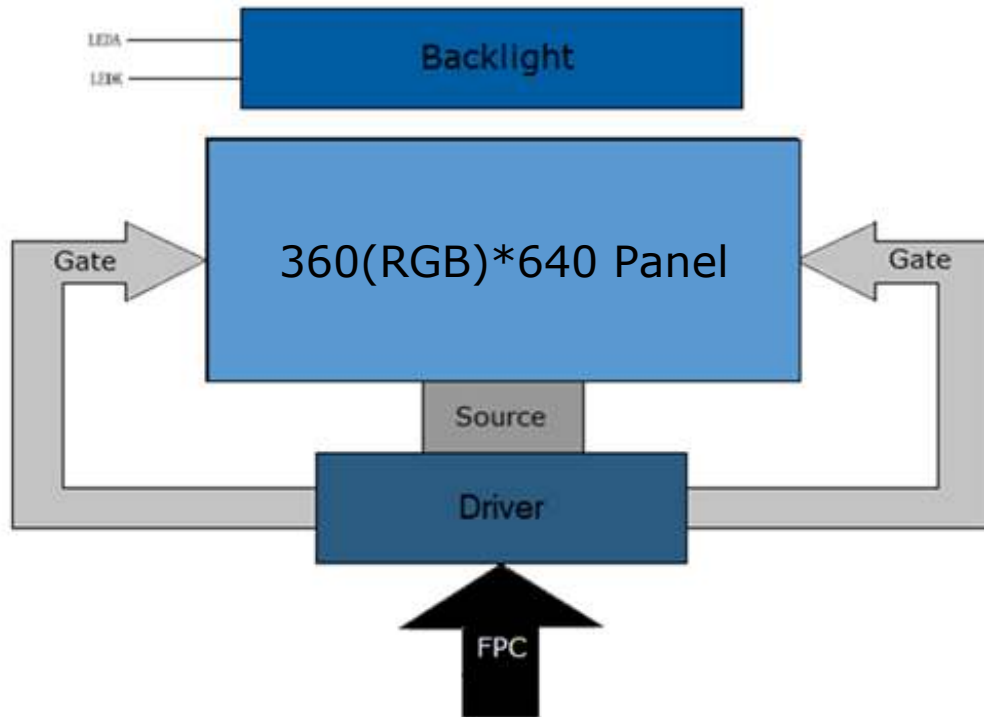

3. TFT Input Terminal Pin Assignment

Recommended TFT Connector: FH19C-20S-0.5SH(10)

Recommended CTP Connector: FH12-8S-0.5SH(55)

NO.	Symbol	Description	I/O
1	NC	Not connected	
2	LEDK	Cathode pin of the backlight	P
3	NC	Not connected	
4	LEDA	Anode pin of the backlight	P
5	NC	Not connected	
6	VCI	Supply voltage (3.3V)	P
7	IOVCC	I/O power supply voltage (1.65-3.3V)	P
8	TE	Tearing effect output	O
9	RESET	External reset signal. Initializes the chip at active low.	I
10	GND	Ground	P
11	D1P	MIPI DSI differential data pair lane 1	I/O
12	D1N		
13	GND	Ground	P
14	CLKP	MIPI DSI differential clocking pair	I/O
15	CLKN		
16	GND	Ground	P
17	D0P	MIPI DSI differential data pair lane 0	I/O
18	D0N		
19	GND	Ground	P
20	GND	Ground	P

I: Input, O: Output, P: Power

3.1 CTP

NO.	Symbol	Description	I/O
1	GND	Ground	P
2	VDDIO	I/O power supply voltage	P
3	VDD	Supply voltage	P
4	SCL	I2C clock input	I
5	SDA	I2C data input and output	I/O
6	INT	External interrupt to the host	I
7	RST	External reset, active low	I
8	GND	Ground	P

4. LCD Optical Characteristics

4.1 Optical Specifications

Item	Symbol	Condition	Min	Typ.	Max	Unit	Note	
Color Gamut	S%	$\theta=0$ Normal viewing angle	--	60	--	%	(3)	
Contrast Ratio	CR		600	800	--	%	(2)	
Response Time	Rising		TR+TF	--	30	45	ms	(4)
	Falling							
Color Filter Chromaticity	White		W_X	0.2648	0.3048	0.3448		(5)(6)
			W_Y	0.2929	0.3329	0.3729		
	Red		R_X	0.5693	0.6093	0.6493		
			R_Y	0.3126	0.3526	0.3926		
	Green		G_X	0.2702	0.3102	0.3502		
			G_Y	0.5524	0.5924	0.6324		
	Blue	B_X	0.1082	0.1482	0.1882			
		B_Y	0.0377	0.0777	0.1177			
Viewing Angle	Hor.	Θ_L	--	80	--	degrees	(1)(6)	
		Θ_R	--	80	--			
	Ver.	Θ_T	--	80	--			
		Θ_B	--	80	--			
Option View Direction	All						(1)	

Optical Specification Reference Notes:

(1) Definition of Viewing Angle: The viewing angle is the angle at which the contrast ratio is greater than 10. The viewing angles are determined for the horizontal or 3,9 o'clock direction and the vertical or 6,12 o'clock direction with respect to the optical axis which is normal to the LCD surface.

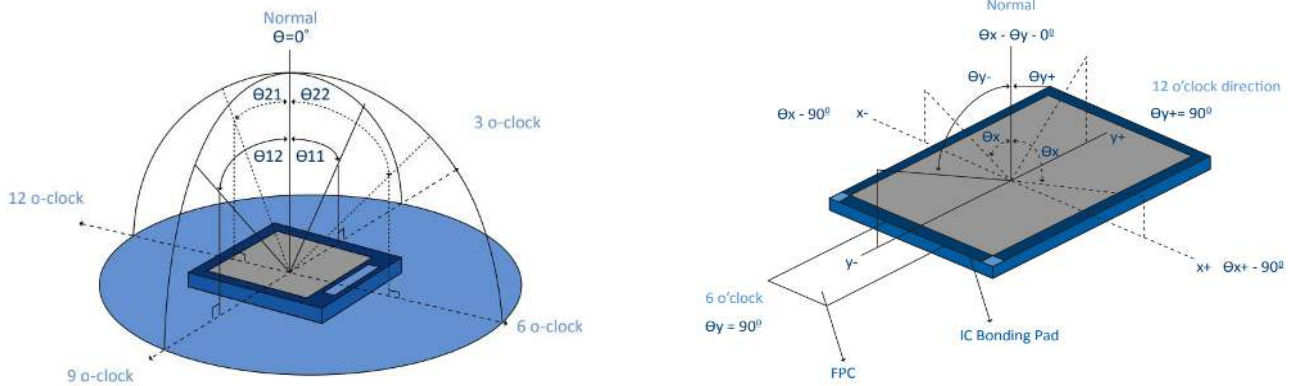

(2) Definition of Contrast Ratio (Cr): measured at the center point of panel. The contrast ratio (Cr) measured on a module, is the ratio between the luminance (Lw) in a full white area (R=G=B=1) and the luminance (Ld) in a dark area (R=G=B=0).

$$Cr = \frac{Lw}{Ld}$$

(3) Definition of transmittance (T%): The transmittance of the panel including the polarizers is measured with electrical driving. The equation for transmittance Tr is:

$$Tr = \frac{I_t}{I_o} \times 100\%$$

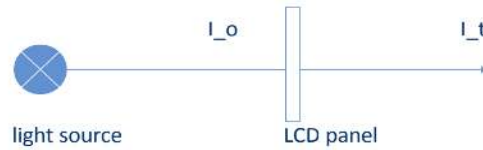

I_o = the brightness of the light source.

I_t = the brightness after panel transmission

(4) Definition of Response Time (T_r , T_f): The rise time 'Tr' is defined as the time for luminance to change from 90% to 10% as a result of a change of the electrical condition. The fall time 'Tf' is defined as the time for luminance to change from 10% to 90% as a result of a change of the electrical condition.

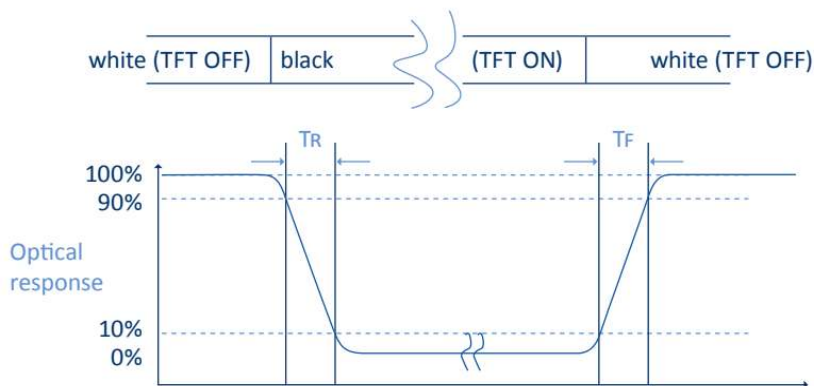

(5) Definition of Color Gamut:

Measuring machine CFT-01. NTSC's Primaries: $R(x,y,Y), G(x,y,Y), B(x,y,Y)$. FPM520 of Westar Display Technologies, INC., which utilized SR-3 for Chromaticity and BM-5A for other optical characteristics. The color chromaticity shall be calculated from the spectral data measured with all pixels first in red, green, blue and white. Measurements shall be made at the center of the panel.

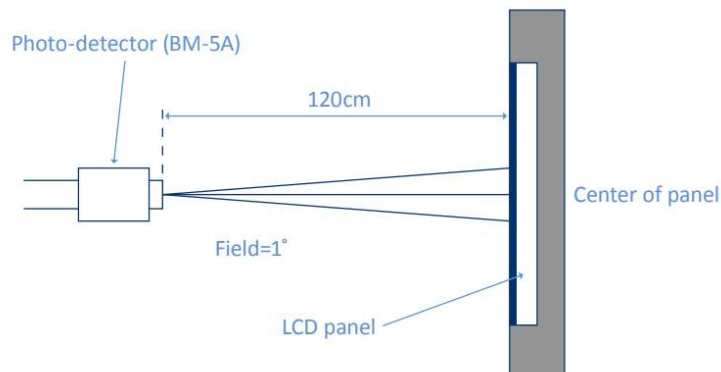
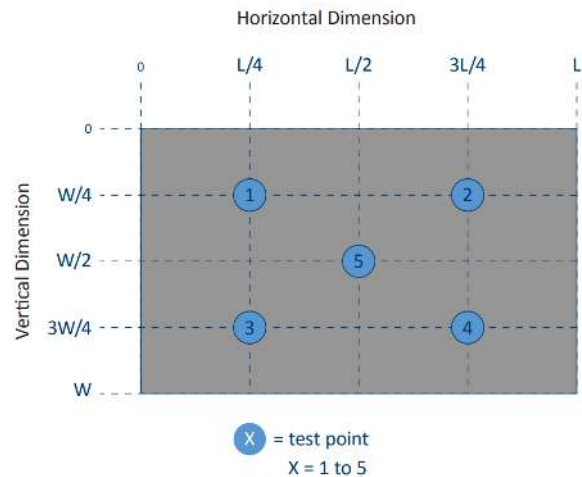
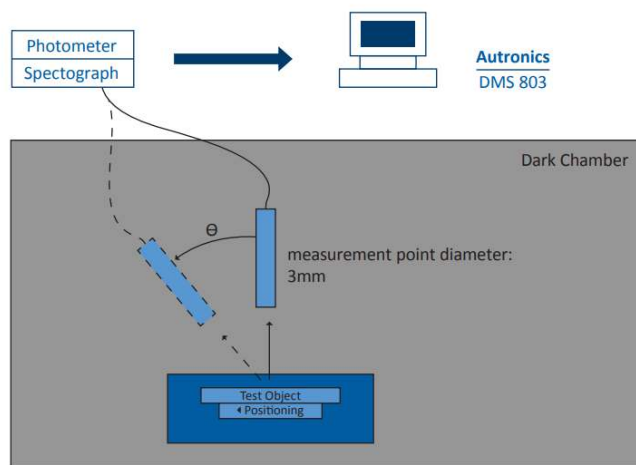

Fig. 1931 CIE chromacity diagram

$$\text{Color gamut: } S = \frac{\text{Area of RGB triangle}}{\text{Area of NTSC triangle}} \times 100\%$$

(6) Definition of Optical Measurement Setup:

The LCD module should be stabilized at a given temperature for 20 minutes to avoid abrupt temperature change during measuring. In order to stabilize the luminance, the measurement should be executed after lighting backlight for 20 minutes.



5. TFT Electrical Characteristics

5.1 Absolute Maximum Rating (Ta=25 °C, VSS=0V)

Characteristics	Symbol	Min	Max	Unit
Digital Supply Voltage	VCI	-0.3	4.8	V
DC/DC Supply Voltage	IOVCC	-0.3	4.6	
Operating Temperature	TOP	-20	+70	°C
Storage Temperature	TST	-30	+80	°C

NOTE: If the absolute maximum rating of the above parameters is exceeded, even momentarily, the quality of the product may be degraded. Absolute maximum ratings specify the values which the product may be physically damaged if exceeded. Be sure to use the product within the range of the absolute maximum ratings.

5.2 DC Electrical Characteristics

Characteristics	Symbol	Min	Typ.	Max	Unit	Note
Power Supply Voltage	VCI	2.5	3.3	3.6	V	
Digital Supply Voltage	IOVCC	1.65	1.8	3.6	V	
Normal Mode Current	IDD	--	36	--	mA	
Level Input Voltage	VIH	0.7IOVCC	--	IOVCC	V	
	VIL	GND	--	0.3IOVCC	V	
Level Output Voltage	VOH	0.8IOVCC	--	IOVCC	V	
	VOL	GND	--	0.2IOVCC	V	

5.4 LED Backlight Characteristics

Item	Symbol	Min	Typ.	Max	Unit	Note
Forward Current	IF	15	20	--	mA	
Forward Voltage	VF	--	19.2	--	V	
LCM Luminance	LV	250	300	--	cd/m ²	Note 3
LED lifetime	Hr	--	50000	--	hour	Note1 & 2
Uniformity	AVg	80	--	--	%	Note 3

The back-light system is edge-lighting type with 6 white LEDs.

Note 1: LED lifetime (Hr) can be defined as the time in which it continues to operate under the condition: $T_a=25\pm 3\text{ }^\circ\text{C}$, typical IL value indicated in the above table until the brightness becomes less than 50%.

Note 2: The “LED lifetime” is defined as the module brightness decrease to 50% original brightness at $T_a=25^\circ\text{C}$ and $I_L=20\text{mA}$. The LED lifetime could be decreased if operating I_L is larger than 20mA. The constant current driving method is suggested.



Backlight LED Circuit

Note 3: Luminance Uniformity of these 9 points is defined as below:

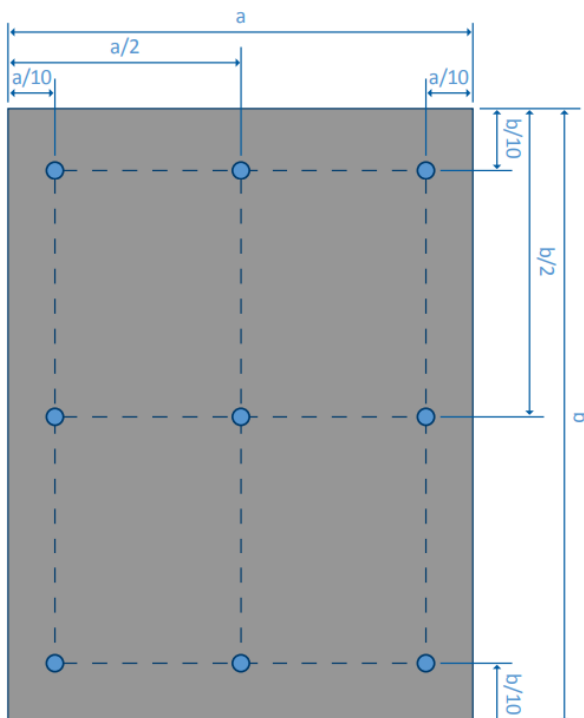

$$\text{Luminance} = \frac{\text{Total Luminance of 9 points}}{9}$$

$$\text{Uniformity} = \frac{\text{minimum luminance in 9 points(1-9)}}{\text{maximum luminance in 9 points(1-9)}}$$

6. MIPI Interface AC Characteristics

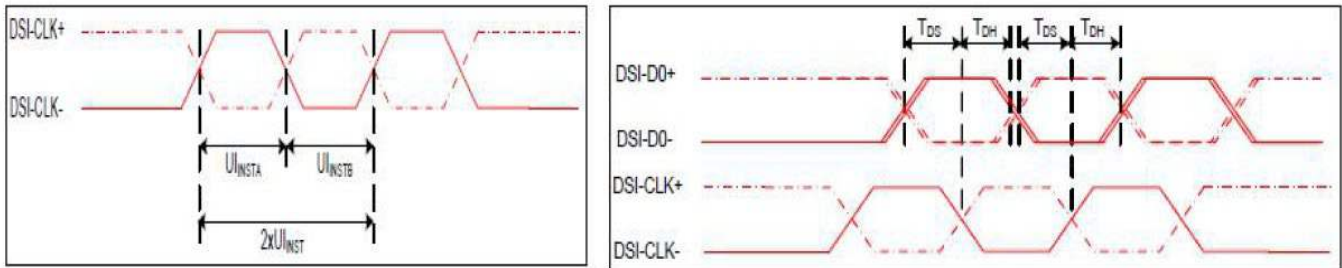

Figure 6.1: DSI Clock Channel Timing Diagram

Signal	Symbol	Parameter	Min	Max	Unit	Note
DSI-CLK+/-	$2 \times UI_{INSTA}$	Double UI Instantaneous	4	25	ns	
DSI-CLK+/-	UI_{INSTA} UI_{INSTB}	UI Instantaneous Halves	2	12.5	ns	$UI = UI_{INSTA} = UI_{INSTB}$
DSI-Dn+/-	t_{DS}	Data to clock setup time	0.15	--	UI	
DSI-Dn+/-	t_{DH}	Data to clock hold time	0.15	--	UI	

Table 6.1: MIPI Interface High Speed Mode Timing Characteristics

6.2 Low Power Mode

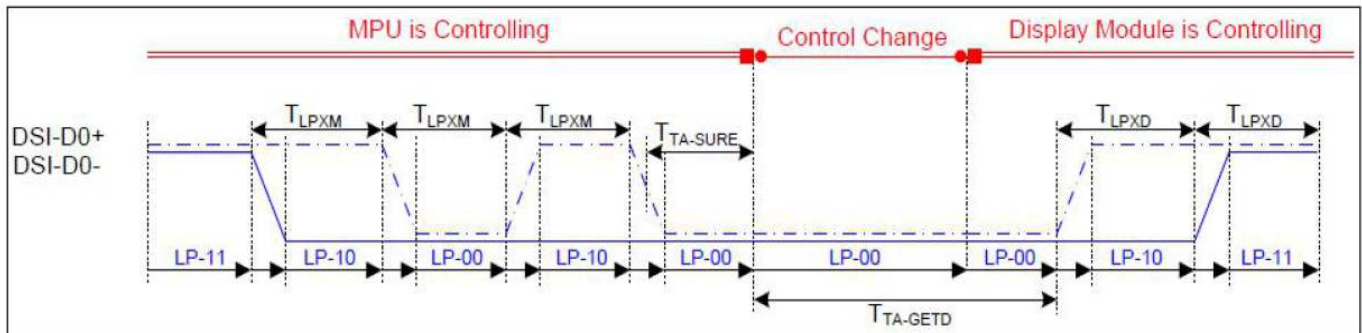

Figure 6.2: Bus Turnaround (BTA) from Display Module to MPU Timing Diagram

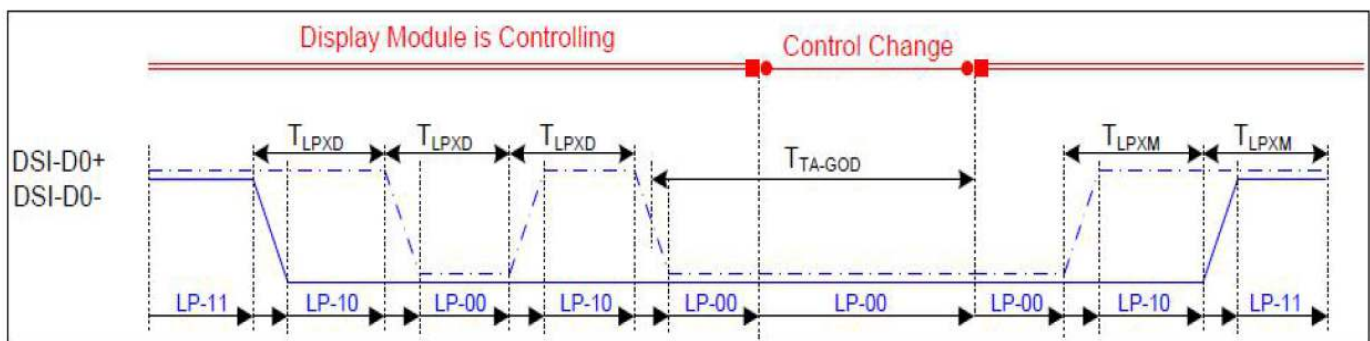

Figure 6.3: Bus Turnaround (BTA) from MPU to Display Module Timing Diagram

Signal	Symbol	Parameter	Min	Max	Unit	Note
DSI-D0+/-	TLPXM	Length of LP-00, LP_01, LP-10 or LP-11 periods MPU-> Display Module	50	75	ns	Input
DSI-D0+/-	TLPXD	Length of LP-00, LP_01, LP-10 or LP-11 periods MPU-> Display Module	50	75	ns	Output
DSI-D0+/-	TTA-SURED	Time-out before the MPU starts driving	TLPXD	2xTLPXD	ns	Output
DSI-D0+/-	TTA-GETD	Time to drive LP-00 by display module	5xTLPXD		ns	Input
DSI-D0+/-	TTA-GOD	Time to drive LP-00 after turnaround request-MPU	4xTLPXD		ns	Output

Table 6.2: MIPI Interface Low Power Mode Timing Characteristics

6.3 Bursts Mode

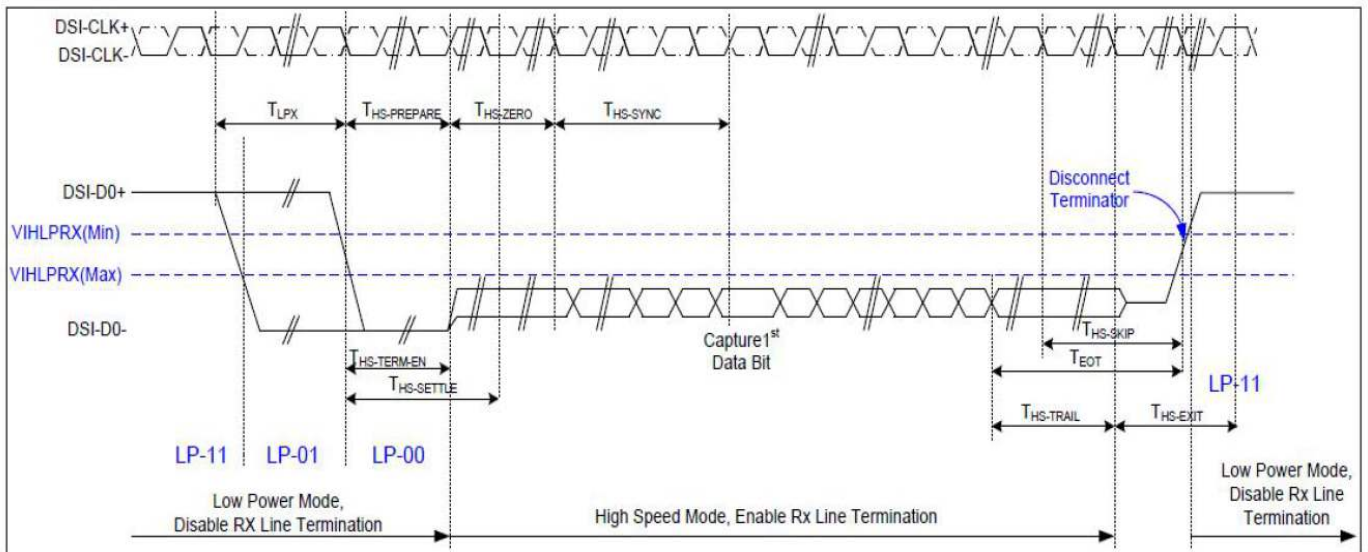

Figure 6.4: Data Lanes Low Power Mode to/from High Speed Mode Timing Diagram

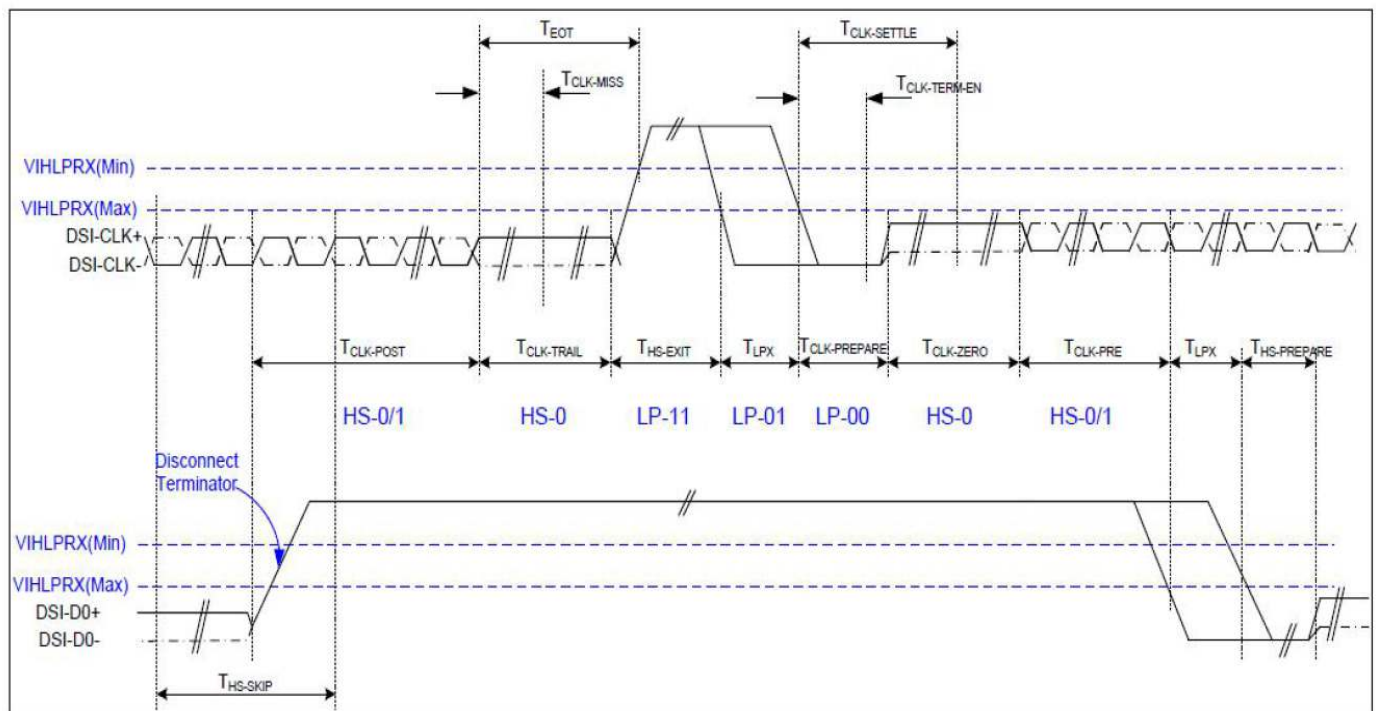

Figure 6.5: Clock Lanes High Speed Mode to/from Low Power Mode Timing Diagram

Signal	Symbol	Parameter	Min	Max	Unit	Note
Low Power Mode to High Speed Mode Timing						
DSI-Dn+/-	TLPX	Length of any low power state period	50	--	ns	Input
DSI-Dn+/-	THS-PREPARE	Time to drive LP-00 to prepare for HS transmission	40+4UI	85+6UI	ns	Input
DSI-Dn+/-	THS-TERM-EN	Time to enable data receiver line termination measured from when Dn crosses VILMAX	--	35+4UI	ns	Input
DSI-Dn+/-	THS-PREPARE+ THS-ZERO	THS-PREPARE+time to drive HS-0 before the sync sequence	140+10UI	--	ns	Input
High Speed Mode to Low Power Mode Timing						
DSI-Dn+/-	THS-SKIP	Time-out at display module to ignore transition period of EoT	40	55+4UI	ns	Input
DSI-Dn+/-	THS-EXIT	Time to drive LP-11 after HS burst	100	--	ns	Input
DSI-Dn+/-	THS-TRIAL	Time to drive flipped differential state after last payload data bit of a HS transmission burst	60+4UI	--	ns	Input
High Speed Mode to/from Low Power Mode Timing						
DSI-CLK+/-	TCLK-POS	Time that the MPU shall continue sending HS clock after the last associated data lane has transitioned to LP mode	60+52UI	--	ns	Input
DSI-CLK+/-	TCLK-TRAIL	Time to drive HS differential state after last payload clock bit of a HS transmission burst	60	--	ns	Input
DSI-CLK+/-	THS-EXIT	Time to drive LP-11 after HS burst	100	--	ns	Input
DSI-CLK+/-	TCLK-PREPARE	Time to drive LP-00 to prepare for HS transmission	38	95	ns	Input
DSI-CLK+/-	TCLK-TERM-EN	Time out at clock and display module to enable HS transmission	--	38	ns	Input
DSI-CLK+/-	TCLK-PREPARE+ TCLK-ZERO	Minimum lead HS-0 drive period before starting clock	300	--	ns	Input
DSI-CLK+/-	TCLK-PRE	Time that the HS clock shall be driven prior to any associated data lane beginning the transition from LP to HS mode	8UI	--	ns	Input
DSI-CLK+/-	TEOT	Time from start of TCLK-TRAIL period to start of LP-11 state	--	105+12UI	ns	Input

Table 6.3: Bursts Mode LP to/from HS Mode Timing Characteristics

6.4 Reset Timing

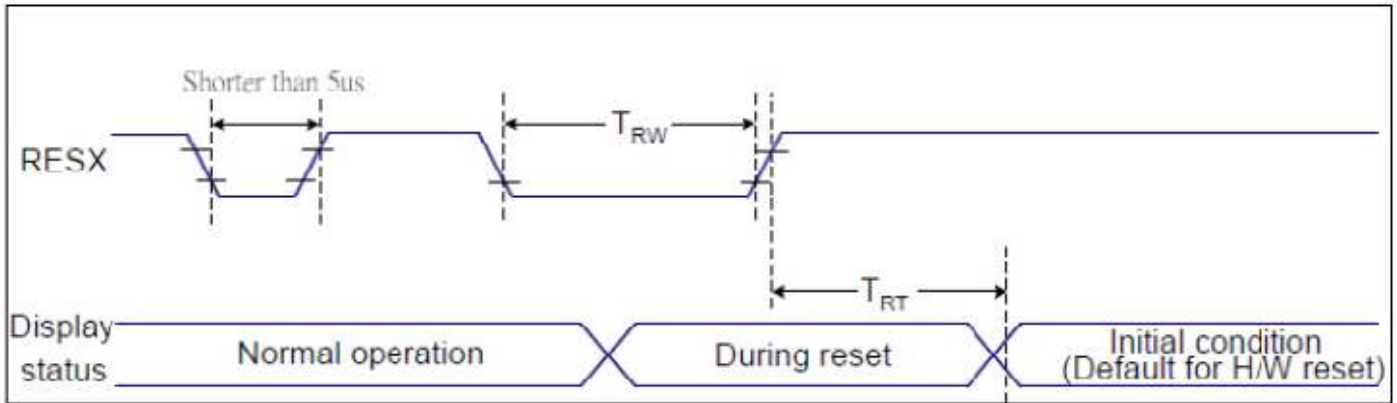

Figure 6.6: Reset Timing Diagram

Related Pins	Symbol	Parameter	Min	Max	Unit
RESX	TRW	Reset pulse duration	10	-	us
	TRT	Reset cancel	-	5 (Note 1,5)	ms
				120 (Note 1, 6, 7)	ms

Notes:

- The reset cancel includes also required time for loading ID bytes, VCOM setting and other settings from NVM (or similar device) to registers. This loading is done every time when there is HW reset cancel time (t_{RT}) within 5ms after a rising edge of RESX.
- Spike due to an electrostatic discharge on RESX line does not because irregular system reset according to the table below:

RESX Pulse	Action
Shorter than 5us	Reset Rejected
Longer than 9us	Reset
Between 5us and 9 us	Reset starts

- During the resetting period, the display will be blanked (the display is entering blanking sequence, which maximum time is 120ms, when reset starts in Sleep Out mode. The display remains the blank state in Sleep in mode) and then return to Default condition for Hardware Reset.
- Spike Rejection also applies during a valid reset pulse as shown below:

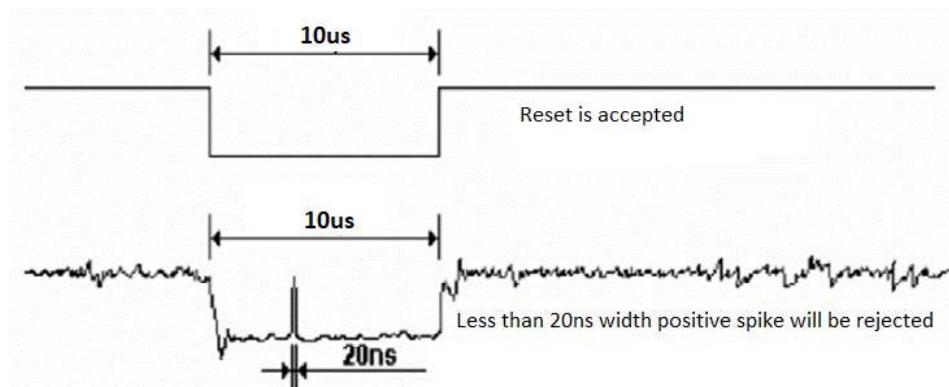

- When Reset applied during Sleep In Mode.
- When Reset applied during Sleep Out Mode.
- It is necessary to wait 5ms after releasing RESX before sending commands. Also Sleep Out command cannot be sent for 120ms.

7. CTP Electrical Characteristics

7.1 Absolute Maximum Rating

Item	Symbol	Min	Max	Unit	Note
Power Supply Voltage	VDD	2.7	3.6	V	1
I/O Digital Voltage	VDDIO	1.8	3.6	V	1
Operating Temperature	T _{OP}	-30	+85	°C	-
Storage Temperature	T _{ST}	-30	+85	°C	-

Note: If used beyond the absolute maximum ratings, FT5436 may permanently damage. It is strongly recommended that the device be used within the electrical characteristics in normal operations. If exposed to the condition not within the electrical characteristics, it may affect the reliability of the device.

7.2 DC Electrical Characteristics (Ta=25°C)

Item	Symbol	Condition	Min	Typ.	Max	Unit	Note
Digital supply voltage	VDD		2.7	3.3	3.47	V	
I/O Digital supply voltage	VDDIO		--	--	--	V	
Normal operation mode current consumption	I _{OPr}	VDD=2.7V Ta=25°C MCLK=17.5M Hz		11		mA	
Monitor mode current consumption	I _{mon}			0.43		mA	
Sleep mode current consumption	I _{slp}			42		uA	
Level input voltage	V _{IH}		0.7VDD		VDD	V	
	V _{IL}		-0.3		0.3VDD	V	
Level output voltage	V _{OH}	I _{OH} =-0.1mA	0.7VDD			V	
	V _{OL}	I _{OL} =0.1mA			0.3VDD	V	

7.3 AC Characteristics

Item	Symbol	Test Condition	Min	Typ.	Max	Unit	Note
OSC clock 1	fosc1	VDDA=2.7V; Ta=25°C	49	50	51	MHz	
Sensor acceptable clock	ftx	VDDA=2.8V; Ta=25°C	0	100	300	kHz	
Sensor output rise time	T _{txr}	VDDA=2.8V; Ta=25°C	-	100	-	Ns	
Sensor output fall time	T _{txf}	VDDA=2.8V; Ta=25°C	-	80	-	Ns	
Sensor input voltage	Trxi	VDDA=2.8V; Ta=25°C	-	5	-	V	

7.4 I2C Interface

The I2C is always configured in the slave mode. The data transfer format is shown below.

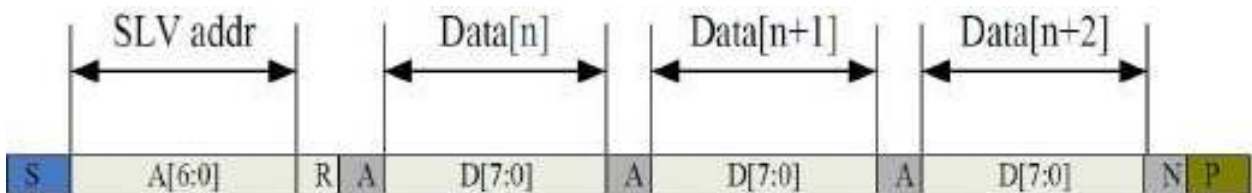
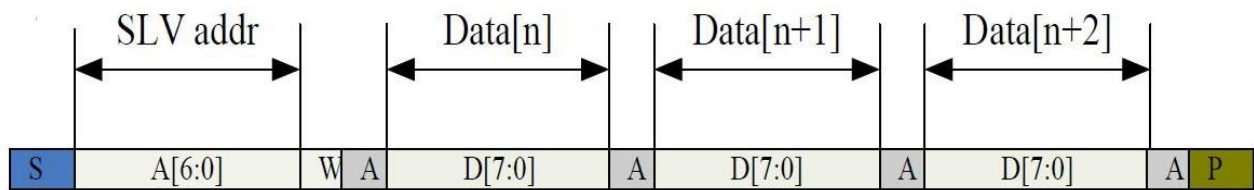
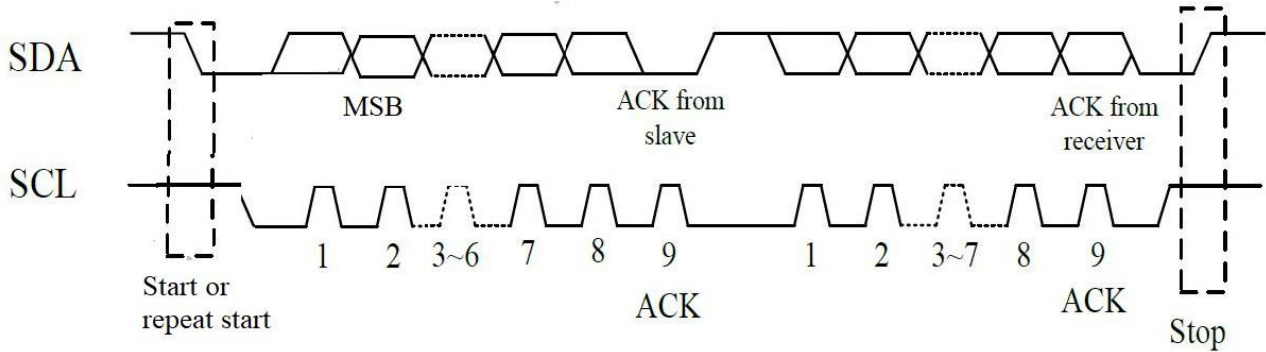

The following table lists the meanings of the mnemonics used in the above figures.

Mnemonics	Description
S	I2C start or I2C restart
A [6:0]	Slave address
R/W	Read/Write bit, '1' for read, '0' for write
A(N)	ACK(NACK)
P	Stop: the indication of the end of a packet (if this bit is missing, S will indicate the end of the current packet and the beginning of the next packet)

I2C Interface Timing Characteristics

Parameter	Min	Max	Unit
SCL frequency	0	400	kHz
Bus free time between a stop and start condition	1.3	-	us
Hold time (repeated) start condition	0.6	-	us
Data setup time	100	-	us
Setup time for a repeated start condition	0.6	-	us
Setup time for stop condition	0.6	-	us

7.5 Power ON/Reset Sequence

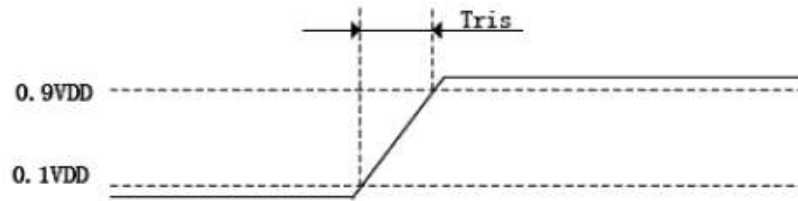

Power On Time

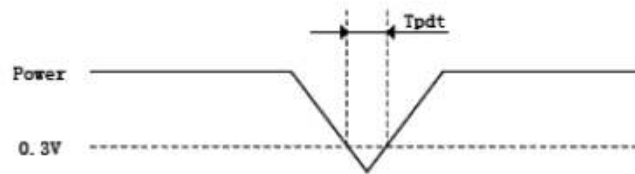

Power Cycle Requirement

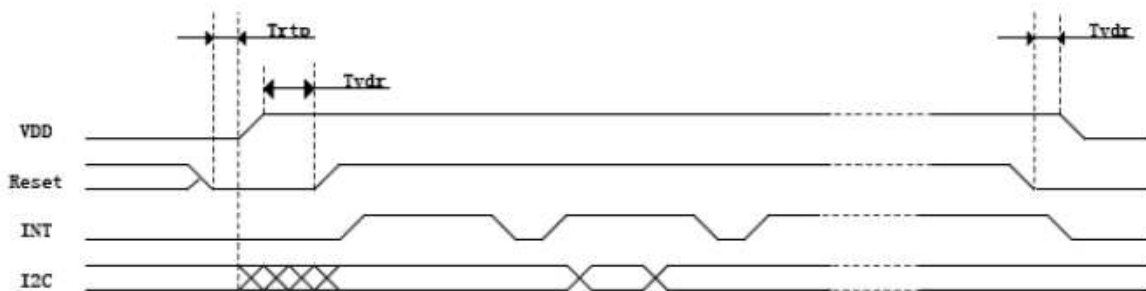

Power on Sequence

Parameter	Description	Min	Max	Units
T_{ris}	Rise time from 0.1VDD to 0.9VDD	--	5	ms
T_{pdt}	Time of voltage being below 0.3V	5	--	ms
T_{rtp}	Time of resetting low before powering on	100	--	us
T_{vdr}	Reset time	1	--	ms
T_{rsi}	Time of starting to report point after resetting	--	200	ms

8. Cautions and Handling Precautions

8.1 Handling and Operating the Module

1. When the module is assembled, it should be attached to the system firmly. Do not warp or twist the module during assembly work.
2. Protect the module from physical shock or any force. In addition to damage, this may cause improper operation or damage to the module and back-light unit.
3. Note that polarizer is very fragile and could be easily damaged. Do not press or scratch the surface.
4. Do not allow drops of water or chemicals to remain on the display surface. If you have the droplets for a long time, staining and discoloration may occur.
5. If the surface of the polarizer is dirty, clean it using some absorbent cotton or soft cloth.
6. The desirable cleaners are water, IPA (Isopropyl Alcohol) or Hexane. Do not use ketene type materials (ex. Acetone), Ethyl alcohol, Toluene, Ethyl acid or Methyl chloride. It might permanent damage to the polarizer due to chemical reaction.
7. If the liquid crystal material leaks from the panel, it should be kept away from the eyes or mouth. In case of contact with hands, legs, or clothes, it must be washed away thoroughly with soap.
8. Protect the module from static; it may cause damage to the CMOS ICs.
9. Use fingerstalls with soft gloves in order to keep display clean during the incoming inspection and assembly process.
10. Do not disassemble the module.
11. Protection film for polarizer on the module shall be slowly peeled off just before use so that the electrostatic charge can be minimized.
12. Pins of I/F connector shall not be touched directly with bare hands.
13. Do not connect, disconnect the module in the “Power ON” condition.
14. Power supply should always be turned on/off by the item Power On Sequence & Power Off Sequence.

8.2 Storage and Transportation.

1. Do not leave the panel in high temperature, and high humidity for a long time. It is highly recommended to store the module with temperature from 0 to 35 °C and relative humidity of less than 70%
2. Do not store the TFT-LCD module in direct sunlight.
3. The module shall be stored in a dark place. When storing the modules for a long time, be sure to adopt effective measures for protecting the modules from strong ultraviolet radiation, sunlight, or fluorescent light.
4. It is recommended that the modules should be stored under a condition where no condensation is allowed. Formation of dewdrops may cause an abnormal operation or a failure of the module. In particular, the greatest possible care should be taken to prevent any module from being operated where condensation has occurred inside.
5. This panel has its circuitry FPC on the bottom side and should be handled carefully in order not to be stressed.