

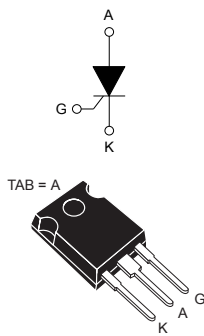

## 30 A, 1200 V automotive grade SCR Thyristor



TO-247 uninsulated

## Features

- AEC-Q101 qualified 
- High junction temperature:  $T_j = 150\text{ }^\circ\text{C}$
- AC off state voltage: +/- 1200 V
- Nominal on-state current:  $30\text{ A}_{\text{RMS}}$
- High noise immunity:  $1000\text{ V}/\mu\text{s}$
- Max. gate triggering current: 50 mA
- ECOPACK2 compliant component

## Applications

- Automotive applications: on board and off board battery charger
- Renewable energy inverters
- Solid state relay
- 3-Phase heating or motor soft start control
- UPS (uninterruptible power supply)
- Bypass SSR / hybrid relay
- Inrush current limiter in battery charger
- AC-DC voltage controlled rectifier
- Industrial welding systems

## Description

The TN3050H-12WY is an automotive grade SCR Thyristor designed for applications such as automotive on-board chargers, solid state AC relays and stationary battery chargers.

This SCR Thyristor, rated for a 30 A RMS power switching, offers superior performance in peak voltage robustness up to 1400 V and surge current handling up to 300 A sine wave pulse. Its key features allow the design of functions such as a 42 A RMS AC switch (dual back-to-back SCRs) and a 38 A average AC-DC controlled rectifier bridge for inrush current limitation.

Available in through-hole TO-247 package, this power package allows a thermal operation up to 30 A RMS with a higher case temperature of  $126\text{ }^\circ\text{C}$ .

Product status	
TN3050H-12WY	
Product summary	
$I_{\text{T(RMS)}}$	30 A
$V_{\text{DRM}}/V_{\text{RRM}}$	1200 V
$V_{\text{DSM}}/V_{\text{RSM}}$	1400 V
$I_{\text{GT}}$	50 mA
$T_j$	$150\text{ }^\circ\text{C}$

# 1 Characteristics

**Table 1. Absolute ratings (limiting values)**

Symbol	Parameter		Value	Unit
$I_{T(RMS)}$	RMS on-state current (180 ° conduction angle)		30	A
$I_{T(AV)}$	Average on-state current (180 ° conduction angle)			
$I_{TSM}^{(1)}$	Non repetitive surge peak on-state current, $V_R = 0$ V	$t_p = 8.3$ ms	330	A
		$t_p = 10$ ms		
$V_{DRM}/V_{RRM}$	Repetitive off-state voltage (50-60 Hz)		1200	V
$di/dt$	$I_G = 2 \times I_{GT}$ , $t_r \leq 100$ ns Critical rate of rise of on-state current	$f = 50$ Hz	200	A/ $\mu$ s
$I_{GM}$	Peak forward gate current	$t_p = 20$ $\mu$ s	8	A
$P_{G(AV)}$	Average gate power dissipation		1	W
$T_{stg}$	Storage junction temperature range		-40 to +150	°C
$T_j$	Operating junction temperature		-40 to +150	°C

1. ST recommend  $I^2t$  value for fusing = 450 A<sup>2</sup>s for  $T_j = 25$  °C and  $t_p = 10$  ms

**Table 2. Electrical characteristics ( $T_j = 25$  °C unless otherwise specified)**

Symbol	Test Conditions		Value	Unit
$I_{GT}$	$V_D = 12$ V, $R_L = 33$ $\Omega$		Min.	10
			Max.	50
$V_{GT}$	$V_D = 12$ V, $R_L = 33$ $\Omega$		Max.	1.3
$V_{GD}$	$V_D = 2/3 \times V_{DRM}$ , $R_L = 3.3$ k $\Omega$	$T_j = 150$ °C	Min.	0.2
$I_H$	$I_T = 500$ mA, gate open		Max.	100
$I_L$	$I_G = 1.2 \times I_{GT}$		Max.	125
$t_{gt}$	$I_T = 60$ A, $V_D = 2/3 \times V_{DRM}$ , $I_G = 100$ mA, $di_G/dt = 0.2$ A/ $\mu$ s		Typ.	1
$dV/dt$	$V_D = 2/3 \times V_{DRM}$ , gate open	$T_j = 150$ °C	Min.	1000
$t_q$	$I_T = 20$ A, $di_T/dt = 10$ A/ $\mu$ s, $V_R = 75$ V, $V_D = 2/3 \times V_{DRM}$ , $dV_D/dt = 20$ V/ $\mu$ s, $t_p = 100$ $\mu$ s	$T_j = 150$ °C	Typ.	150
$V_{TM}$	$I_{TM} = 60$ A, $t_p = 380$ $\mu$ s		Max.	1.65
$V_{TO}$	Threshold voltage		$T_j = 150$ °C	Max.
$R_D$	Dynamic resistance		$T_j = 150$ °C	Max.
$I_{DRM}/I_{RRM}$	$V_D = V_{DRM}$ , $V_R = V_{RRM}$	$T_j = 25$ °C	Max.	5
		$T_j = 125$ °C	Max.	3
		$T_j = 150$ °C	Max.	5
$I_{DSM}/I_{RSM}$	$V_D = V_{DSM}$ , $V_R = V_{RSM}$		$T_j = 25$ °C	Max.

Table 3. Thermal parameters

Symbol	Parameter	Value	Unit
$R_{th(j-c)}$	Junction to case (DC, max.)	0.8	°C/W
$R_{th(j-a)}$	Junction to ambient (typ.)	50	

## 1.1 Characteristics curves

**Figure 1. Maximum average power dissipation versus average on-state current**

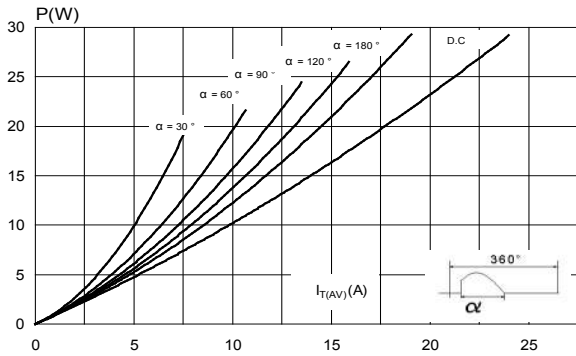

**Figure 2. Average and DC on-state current versus case temperature**

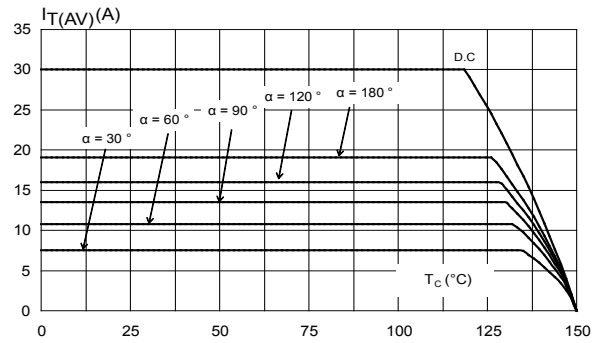

**Figure 3. On-state characteristics (maximum values)**

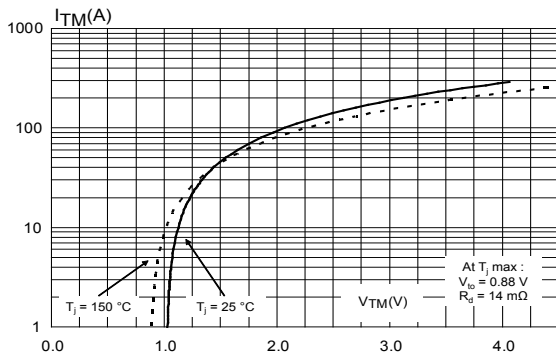

**Figure 4. Average and D.C. on-state current versus ambient temperature**

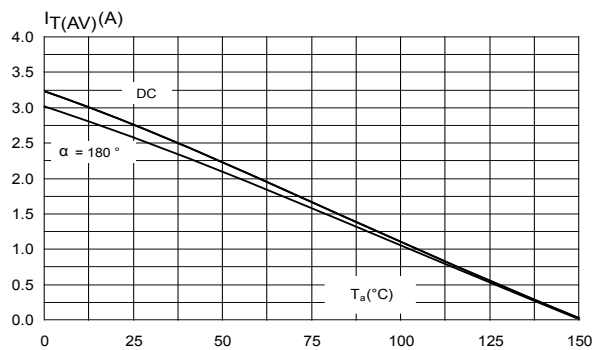

**Figure 5. Relative variation of thermal impedance junction to case and junction to ambient versus pulse duration**

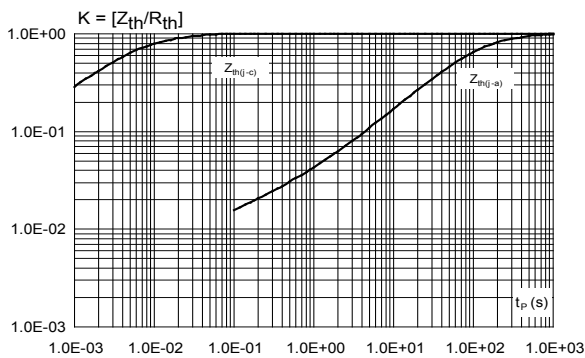

**Figure 6. Surge peak on-state current versus number of cycles**

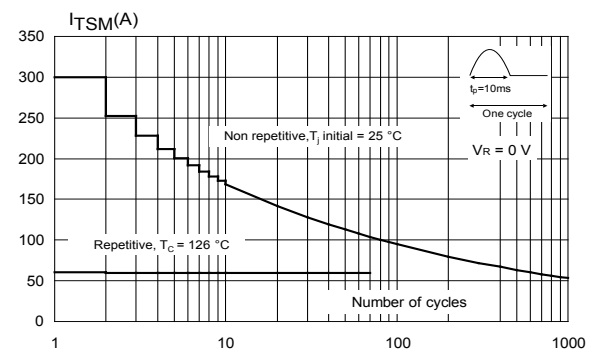

**Figure 7. Non repetitive surge peak on-state current for a sinusoidal pulse ( $t_p < 10$  ms)**

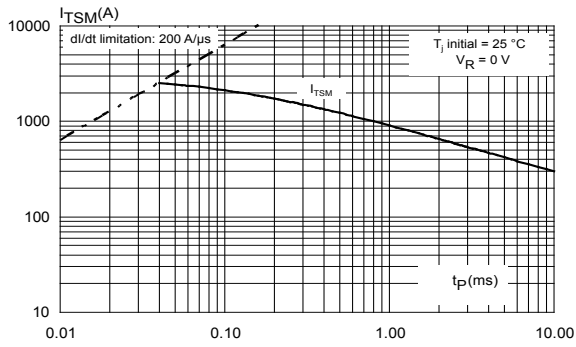

**Figure 8. Relative variation of holding and latching current versus junction temperature (typical values)**

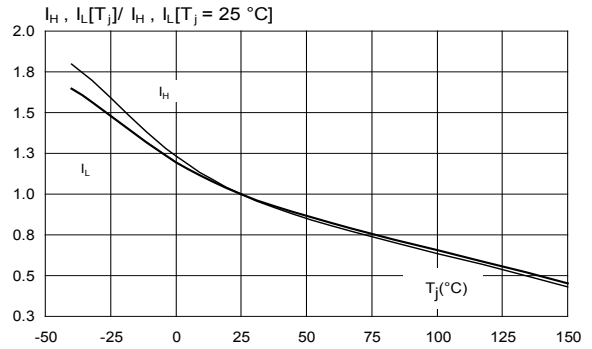

**Figure 9. Relative variation of gate triggering current and voltage versus junction temperature**

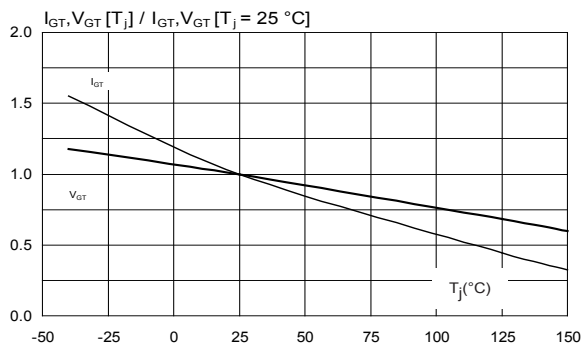

**Figure 10. Relative variation of the static dV/dt immunity versus junction temperature (typical values)**

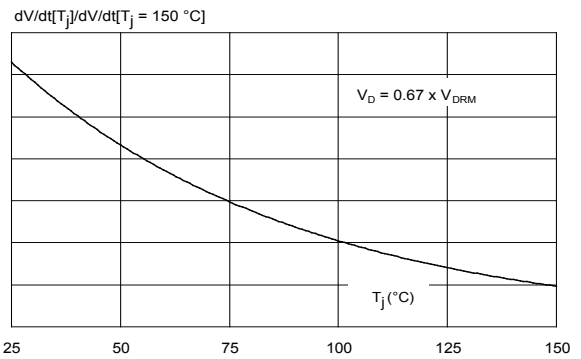

**Figure 11. Relative variation of leakage current versus junction temperature for different values of blocking voltage**

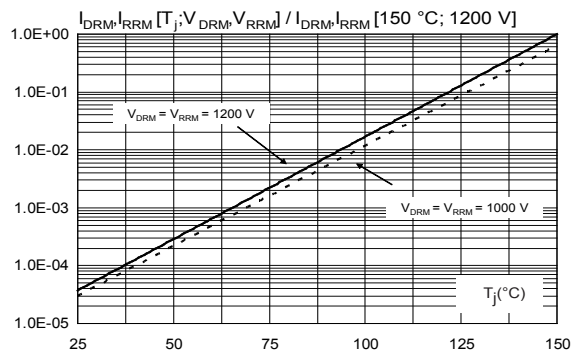

## 2 Package information

In order to meet environmental requirements, ST offers these devices in different grades of **ECOPACK** packages, depending on their level of environmental compliance. ECOPACK specifications, grade definitions and product status are available at: [www.st.com](http://www.st.com). ECOPACK is an ST trademark.

### 2.1 TO-247 package information

- Epoxy meets UL 94,V0
- Recommended torque value: 0.8 N·m
- Maximum torque value: 1 N·m

Figure 12. TO-247 package outline

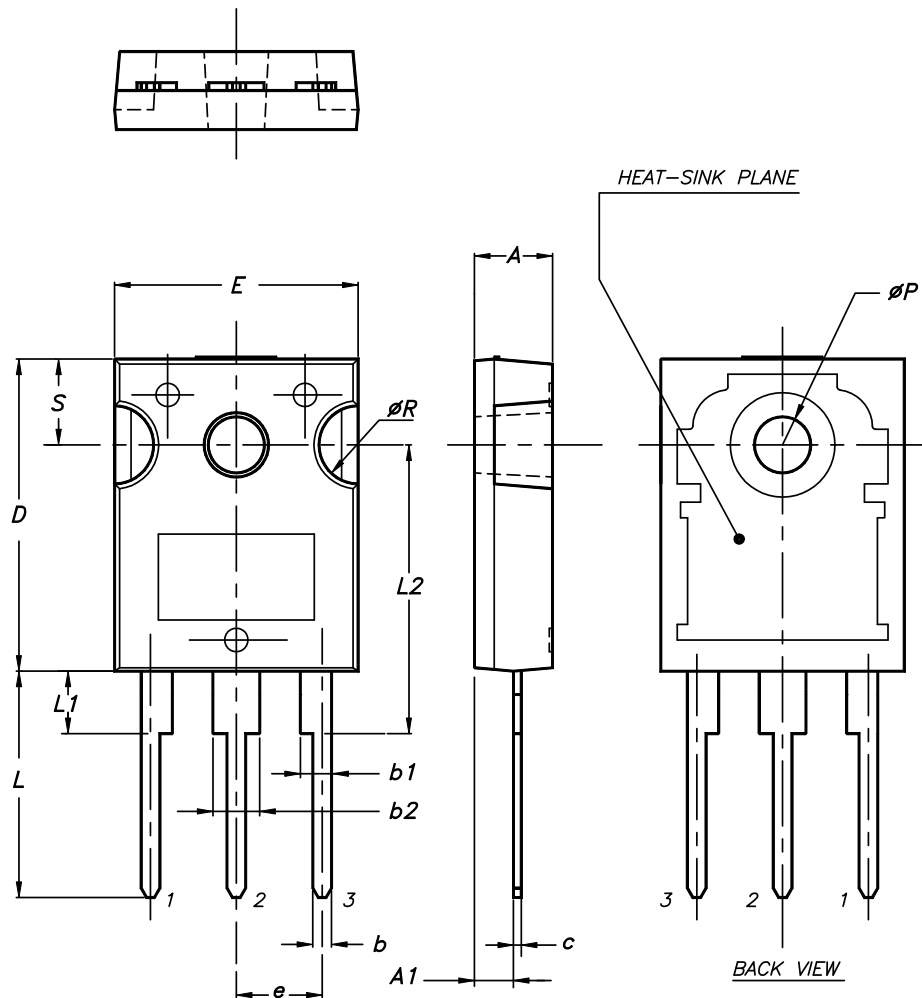

0075325\_9

**Table 4. TO-247 package mechanical data**

Dim.	Dimensions					
	Millimeters			Inches <sup>(1)</sup>		
	Min.	Typ.	Max.	Min.	Typ.	Max.
A	4.85		5.15	0.1909		0.2028
A1	2.20		2.60	0.0866		0.1024
b	1.0		1.40	0.0394		0.0551
b1	2.0		2.40	0.0787		0.0945
b2	3.0		3.40	0.1181		0.1339
c	0.40		0.80	0.0157		0.0315
D <sup>(2)</sup>	19.85		20.15	0.7815		0.7933
E	15.45		15.75	0.6083		0.6201
e	5.30	5.45	5.60	0.2087	0.2146	0.2205
L	14.20		14.80	0.5591		0.5827
L1	3.70		4.30	0.1457		0.1693
L2		18.50			0.7283	
ØP <sup>(3)</sup>	3.55		3.65	0.1398		0.1437
ØR	4.50		5.50	0.1772		0.2165
S	5.30	5.50	5.70	0.2087	0.2165	0.2244

1. Inch dimensions given only for reference
2. Dimension D plus gate protrusion does not exceed 20.5 mm
3. Resin thickness around the mounting hole is not less than 0.9 mm

### 3 Ordering information

**Table 5. Ordering information**

Order code	Marking	Package	Weight	Base qty.	Delivery mode
TN3050H-12WY	TN3050H12Y	TO-247	4.4 g	50	Tube



## Revision history

**Table 6. Document revision history**

Date	Revision	Changes
16-Sep-2016	1	Initial release.
03-Oct-2016	2	Updated Table 3. Thermal parameters.
15-Jan-2019	3	Updated Table 5. Ordering information.
05-Aug-2019	4	Updated Section Description and Table 1. Absolute ratings (limiting values).
31-Mar-2020	5	Updated Figure 6 and Figure 7.

**IMPORTANT NOTICE – PLEASE READ CAREFULLY**

STMicroelectronics NV and its subsidiaries (“ST”) reserve the right to make changes, corrections, enhancements, modifications, and improvements to ST products and/or to this document at any time without notice. Purchasers should obtain the latest relevant information on ST products before placing orders. ST products are sold pursuant to ST’s terms and conditions of sale in place at the time of order acknowledgement.

Purchasers are solely responsible for the choice, selection, and use of ST products and ST assumes no liability for application assistance or the design of Purchasers’ products.

No license, express or implied, to any intellectual property right is granted by ST herein.

Resale of ST products with provisions different from the information set forth herein shall void any warranty granted by ST for such product.

ST and the ST logo are trademarks of ST. For additional information about ST trademarks, please refer to [www.st.com/trademarks](http://www.st.com/trademarks). All other product or service names are the property of their respective owners.

Information in this document supersedes and replaces information previously supplied in any prior versions of this document.

© 2020 STMicroelectronics – All rights reserved