

TMAG5123-Q1 Automotive In-Plane, High-Precision, High-Voltage, Hall-Effect Switch

1 Features

- AEC-Q100 qualified for automotive applications:
 - Temperature grade 0: -40°C To $+150^{\circ}\text{C}$, T_A
- In-plane, omnipolar Hall-effect switch
- High magnetic sensitivity:
 - TMAG5123B-Q1: 4.1 mT (typical)
 - TMAG5123C-Q1: 7.5 mT (typical)
 - TMAG5123D-Q1: 10.9 mT (typical)
- Supports a wide voltage range
 - 2.7-V to 38-V operating V_{CC} range
 - No external regulator required
- 30kHz continuous conversion
- Open-drain output
- SOT-23 package option
- Protection features
 - Supports up to 40-V load dump
 - Reverse battery protection to -20-V
 - Output short-circuit protection
 - Output current limitation

2 Applications

- Gear shift
- Interior lighting
- Door lock
- Door handle
- Sunroof/Trunk closure

3 Description

The TMAG5123-Q1 is a chopper-stabilized omnipolar, active-low, in-plane, Hall-effect switch sensor. The TMAG5123-Q1 eases mechanical placement of the sensor by measuring magnetic fields parallel to the surface of the printed circuit board (PCB) in a surface mount SOT-23 package.

Different sensitivity levels are available to match the specific requirement of the application. When the applied magnetic flux density value exceeds the operating point (BOP) threshold in absolute magnetic field values, the open-drain output produces a low-state voltage. The output remains low until the applied field decreases to less than the release point (BRP) threshold also in absolute terms.

The TMAG5123-Q1 incorporates a wide 2.7-V to 38-V operating voltage range and reverse polarity protection of up to -20-V , enabling robust operation for industrial and automotive applications.

Device Information

PART NUMBER	PACKAGE ⁽¹⁾	BODY SIZE (NOM)
TMAG5123-Q1	SOT-23 (3)	2.92 mm × 1.30 mm

- (1) For all available packages, see the package option addendum at the end of the data sheet.

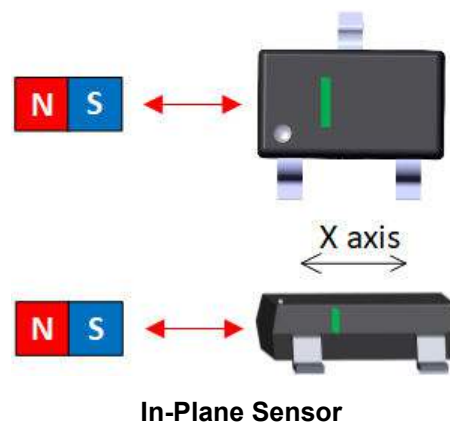

Table of Contents

1 Features	1	8.3 Feature Description.....	9
2 Applications	1	8.4 Device Functional Modes.....	14
3 Description	1	9 Application and Implementation	15
4 Revision History	2	9.1 Application Information.....	15
5 Device Comparison Table	3	9.2 Typical Applications.....	15
6 Pin Configuration and Functions	3	10 Power Supply Recommendations	19
7 Specifications	4	11 Layout	19
7.1 Absolute Maximum Ratings	4	11.1 Layout Guidelines.....	19
7.2 ESD Ratings	4	11.2 Layout Example.....	19
7.3 Recommended Operating Conditions	4	12 Device and Documentation Support	20
7.4 Thermal Information	4	12.1 Receiving Notification of Documentation Updates..	20
7.5 Electrical Characteristics	5	12.2 Support Resources.....	20
7.6 Magnetic Characteristics	5	12.3 Trademarks.....	20
7.7 Typical Characteristics.....	6	12.4 Electrostatic Discharge Caution.....	20
8 Detailed Description	9	12.5 Glossary.....	20
8.1 Overview.....	9	13 Mechanical, Packaging, and Orderable	
8.2 Functional Block Diagram.....	9	Information	20

4 Revision History

Changes from Revision * (October 2020) to Revision A (August 2021)	Page
• Changed device status from: Advanced Information to: Production Data.....	1

5 Device Comparison Table

DEVICE	DEVICE OPTION	Threshold level (BOP)
TMAG5123-Q1	B	4.1mT
	C	7.5mT
	D	10.9mT

6 Pin Configuration and Functions

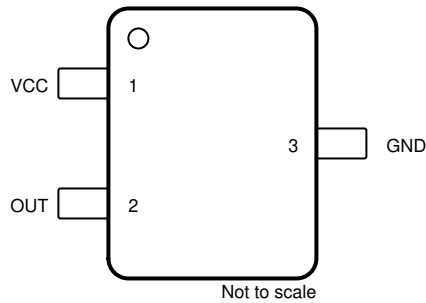

Figure 6-1. DBZ Package 3-Pin SOT-23 Top View

Table 6-1. Pin Functions

PIN		TYPE	DESCRIPTION
NO.	NAME		
1	VCC	Power supply	2.7-V to 38-V power supply. Connect a ceramic capacitor with a value of at least 0.01 μ F (minimum) between VCC and ground.
2	OUT	Output	Hall sensor open-drain output. The open drain requires a pull-up resistor
3	GND	Ground	Ground reference.

7 Specifications

7.1 Absolute Maximum Ratings

over operating free-air temperature range (unless otherwise noted)⁽¹⁾

		MIN	MAX	UNIT
Power Supply Voltage	V_{CC}	-20	40	V
Magnetic Flux Density, B _{MAX}		Unlimited		T
Junction temperature, T_J	Junction temperature, T_J		175	°C
Storage temperature, T_{stg}		-65	150	°C

- (1) Stresses beyond those listed under *Absolute Maximum Rating* may cause permanent damage to the device. These are stress ratings only, which do not imply functional operation of the device at these or any other conditions beyond those indicated under *Recommended Operating Condition*. Exposure to absolute-maximum-rated conditions for extended periods may affect device reliability.

7.2 ESD Ratings

			VALUE	UNIT
$V_{(ESD)}$	Electrostatic discharge	Human body model (HBM), per ANSI/ESDA/ JEDEC JS-001, all pins ⁽¹⁾	±2000	V
		Charged device model (CDM), per JEDEC specification JESD22-C101, all pins ⁽²⁾	± 500	

- (1) JEDEC document JEP155 states that 500-V HBM allows safe manufacturing with a standard ESD control process.
 (2) JEDEC document JEP157 states that 250-V CDM allows safe manufacturing with a standard ESD control process.

7.3 Recommended Operating Conditions

over operating free-air temperature range (unless otherwise noted)

		MIN	MAX	UNIT
V_{CC}	Power supply voltage	2.7	38	V
V_O	Output pin voltage	0	38	V
I_{SINK}	Output pin current sink	0	20	mA
T_A	Ambient temperature	-40	150	°C

7.4 Thermal Information

THERMAL METRIC ⁽¹⁾		TMAG5123	UNIT
		DBZ (SOT-23)	
		3 PINS	
$R_{\theta JA}$	Junction-to-ambient thermal resistance	197.7	°C/W
$R_{\theta JC(top)}$	Junction-to-case (top) thermal resistance	87.1	°C/W
$R_{\theta JB}$	Junction-to-board thermal resistance	27.4	°C/W
Ψ_{JT}	Junction-to-top characterization parameter	3.7	°C/W
Ψ_{JB}	Junction-to-board characterization parameter	27.1	°C/W

- (1) For more information about traditional and new thermal metrics, see the [Semiconductor and IC Package Thermal Metrics](#) application report.

7.5 Electrical Characteristics

over operating free-air temperature range (unless otherwise noted)

PARAMETER		TEST CONDITIONS	MIN	TYP	MAX	UNIT
POWER SUPPLY						
I_{CC}	Operating supply current	$V_{CC} = 2.7V \text{ to } 38V, T_A = 25^\circ C$		3.5		mA
I_{CC}	Operating supply current	$V_{CC} = 2.7V \text{ to } 38V, T_A = -40^\circ C \text{ to } 150^\circ C$		3.5	5.4	mA
I_{RCC}	Reverse-battery current	$V_{CC} = -20V$	-100			μA
t_{ON}	Power-on-time			62.5		μs
P_{OS}	Power-on-state	$V_{CC} > V_{CCmin}, t > t_{ON}$		High		
OUTPUT						
V_{OL}	Low-level output voltage	$I_{OL} = 5mA$	0		0.5	V
I_{OH}	Output leakage current	$V_{CC} = 5V$		0.1	1	μA
I_{SC}	Output short-circuit current			65	100	mA
t_R	Output rise time	$R_L = 1k\Omega, C_L = 50pF, V_{CC} = 12V$		0.2		μs
t_F	Output fall time	$R_L = 1k\Omega, C_L = 50pF, V_{CC} = 12V$		0.2		μs
t_{PD}	Propagation delay time	Change in B field to change in output		50		μs
FREQUENCY RESPONSE						
f_{CHOP}	Chopping frequency			320		kHz
f_{BW}	Signal bandwidth			10		kHz

7.6 Magnetic Characteristics

over operating free-air temperature range (unless otherwise noted)

PARAMETER		TEST CONDITIONS	MIN	TYP	MAX	UNIT
TMAG5123B						
B_{OP}	Magnetic field operating point	$V_{CC} = 2.7V \text{ to } 38V, T_A = -40^\circ C \text{ to } 150^\circ C$	± 2.2	± 4.1	± 6	mT
B_{RP}	Magnetic field release point		± 0.3	± 2.2	± 4	mT
B_{HYS}	Magnetic hysteresis $B_{OP} - B_{RP}$		± 0.5	± 1.9	± 3	mT
TMAG5123C						
B_{OP}	Magnetic field operating point	$V_{CC} = 2.7V \text{ to } 38V, T_A = -40^\circ C \text{ to } 150^\circ C$	± 5.5	± 7.5	± 9.5	mT
B_{RP}	Magnetic field release point		± 3.5	± 5.5	± 7.5	mT
B_{HYS}	Magnetic hysteresis $B_{OP} - B_{RP}$		± 0.5	± 2	± 3	mT
TMAG5123D						
B_{OP}	Magnetic field operating point	$V_{CC} = 2.7V \text{ to } 38V, T_A = -40^\circ C \text{ to } 150^\circ C$	± 8.7	± 10.9	± 13	mT
B_{RP}	Magnetic field release point		± 6.7	± 8.9	± 11	mT
B_{HYS}	Magnetic hysteresis $B_{OP} - B_{RP}$		± 0.5	± 2	± 3	mT

TMAG5123-Q1

SLYS032A – OCTOBER 2020 – REVISED AUGUST 2021

7.7 Typical Characteristics

at $T_A = 25\text{ }^\circ\text{C}$ typical and $V_{CC} = 12\text{V}$ (unless otherwise noted)

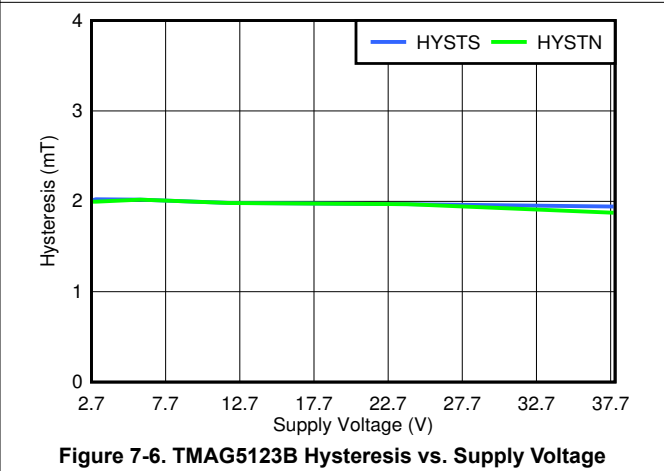
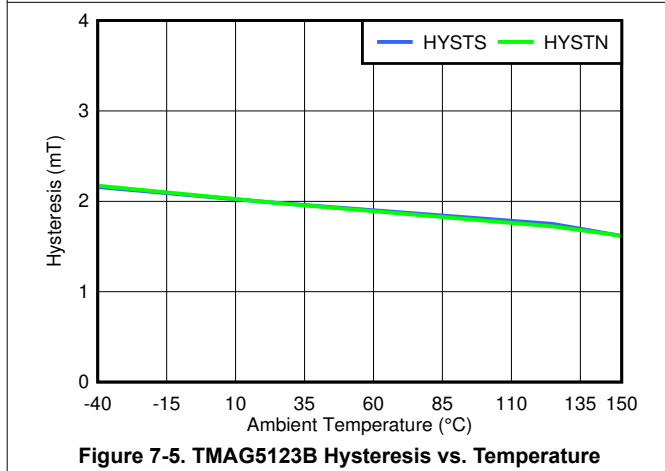
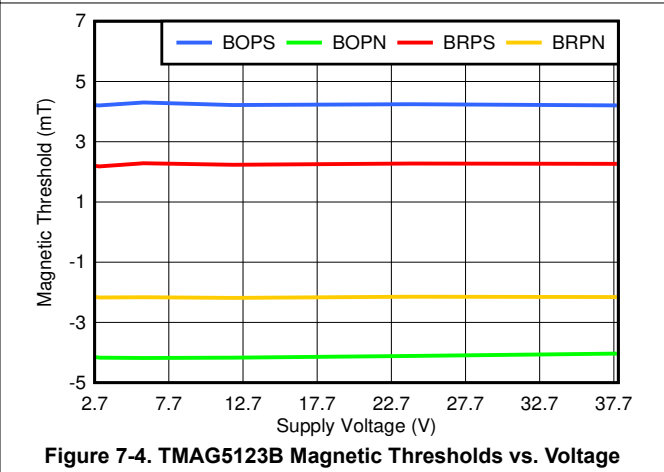
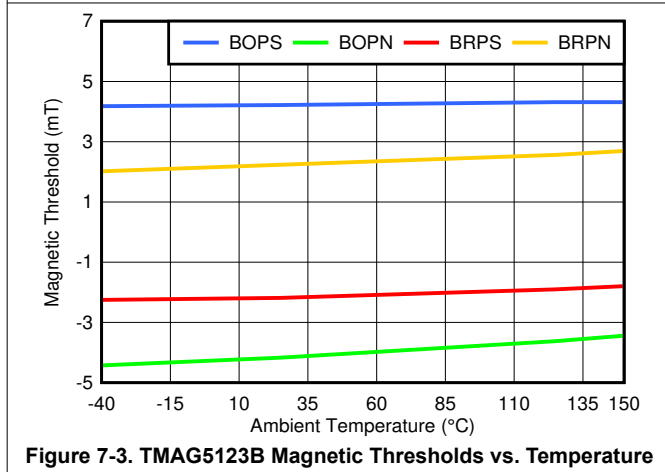
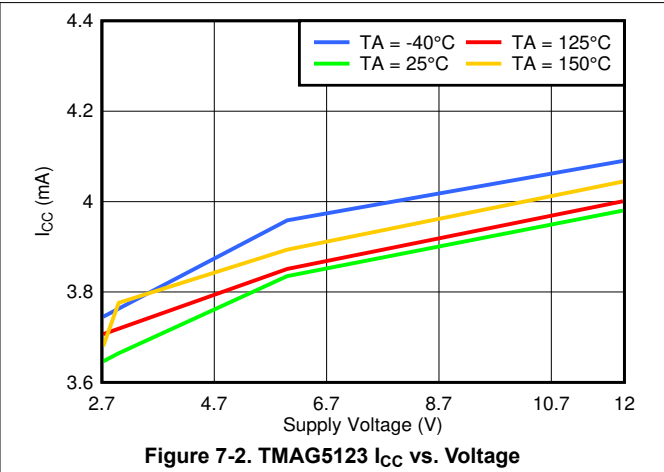
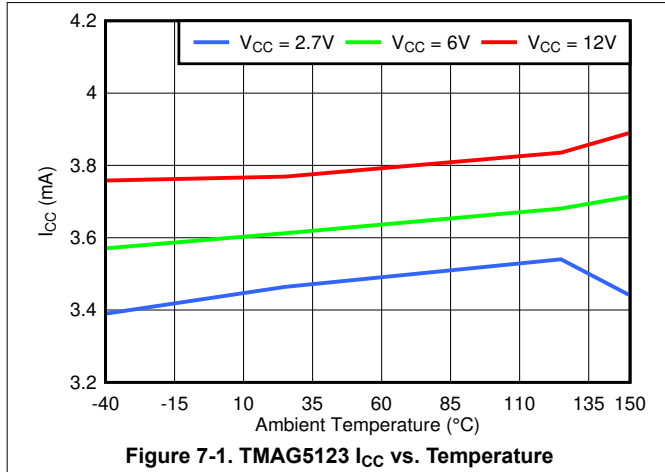

7.7 Typical Characteristics (continued)

at $T_A = 25^\circ\text{C}$ typical and $V_{CC} = 12\text{V}$ (unless otherwise noted)

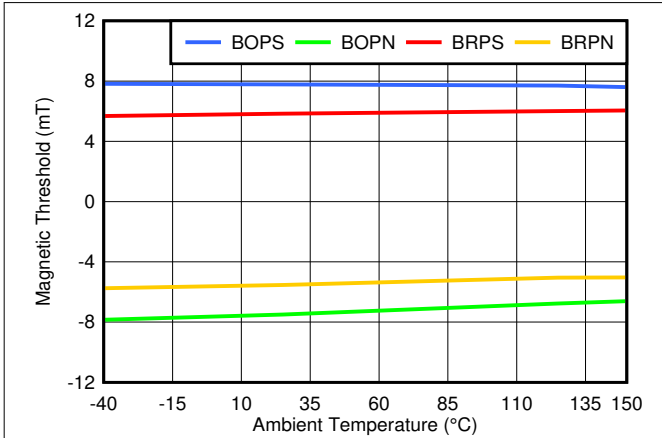

Figure 7-7. TMAG5123C Magnetic Thresholds vs. Temperature

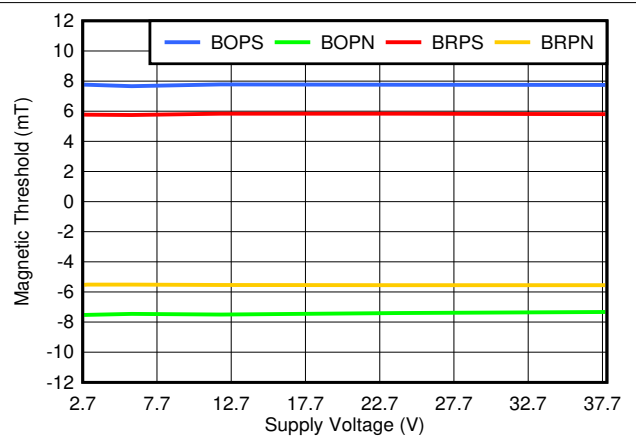

Figure 7-8. TMAG5123C Magnetic Thresholds vs. Voltage

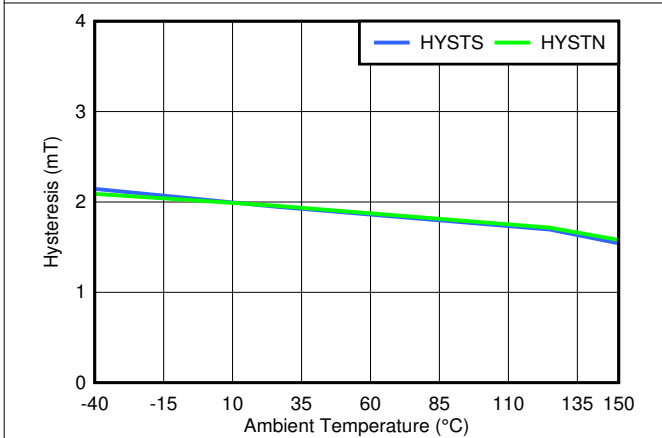

Figure 7-9. TMAG5123C Hysteresis vs. Temperature

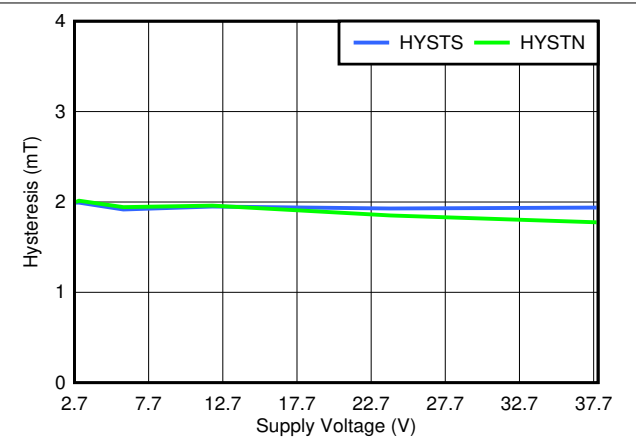

Figure 7-10. TMAG5123C Hysteresis vs. Supply Voltage

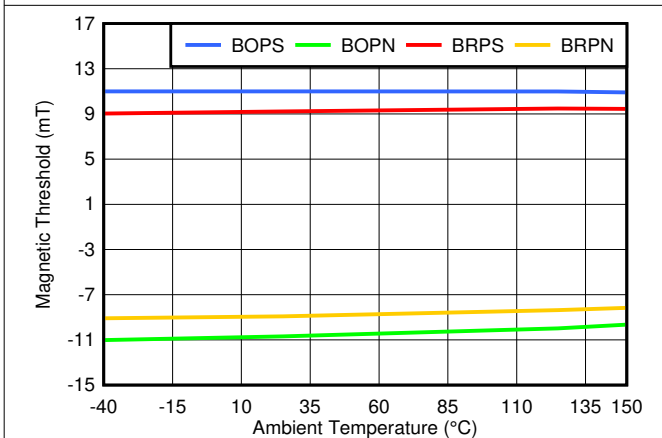

Figure 7-11. TMAG5123D Magnetic Thresholds vs. Temperature

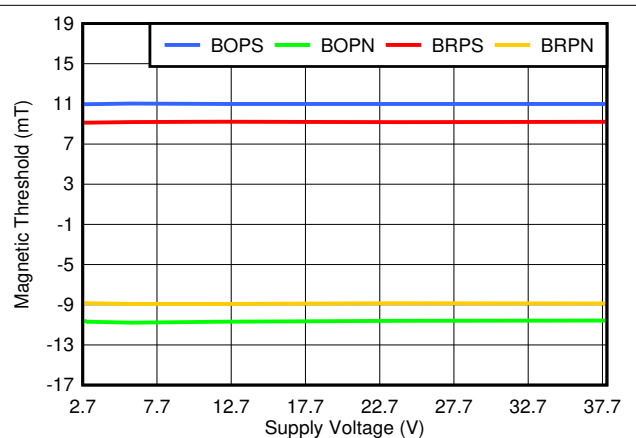

Figure 7-12. TMAG5123D Magnetic Thresholds vs. Voltage

7.7 Typical Characteristics (continued)

at $T_A = 25\text{ }^\circ\text{C}$ typical and $V_{CC} = 12\text{V}$ (unless otherwise noted)

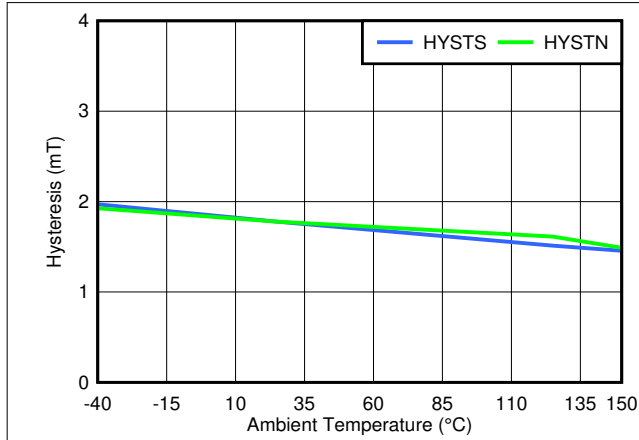

Figure 7-13. TMAG5123D Hysteresis vs. Temperature

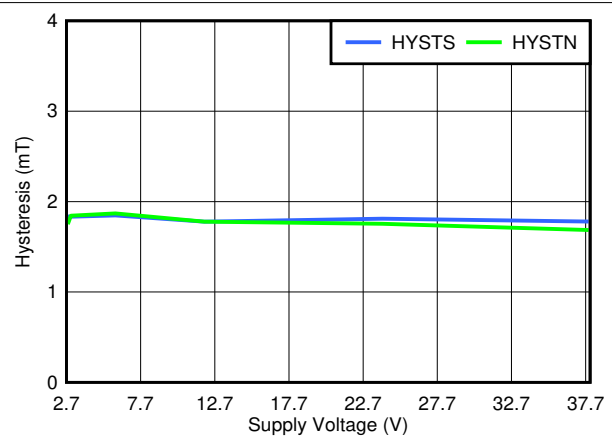

Figure 7-14. TMAG5123D Hysteresis vs. Supply Voltage

8 Detailed Description

8.1 Overview

The TMAG5123-Q1 device is a chopper-stabilized Hall sensor with a digital omnipolar switch output for magnetic sensing applications. The TMAG5123-Q1 device can be powered with a supply voltage range between 2.7-V and 38 V, and can withstand -20 -V reverse battery conditions continuously. Note that the TMAG5123-Q1 device will not operate when approximately -20 -V to 2.7-V is applied to the VCC pin (with respect to GND). In addition, the device can withstand voltages up to 40 V for transient durations.

While most of the Hall-effect sensors switch their output in the presence of a vertical field, the TMAG5123-Q1 will switch the output in the presence of a horizontal field. The TMAG5123-Q1 is then an in-plane or vertical sensor, sensitive to a horizontal or parallel magnetic fields.

The omnipolar configuration allows the Hall sensor to respond to either a south or north pole. A strong magnetic field of either polarity will cause the output to pull low (operate point, BOP), and a weaker magnetic field will cause the output to release (release point, BRP). Hysteresis is included in between the operate and release points, so magnetic field noise will not trip the output accidentally.

An external pullup resistor is required on the OUT pin. The OUT pin can be pulled up to VCC, or to a different voltage supply. This allows for easier interfacing with controller circuits.

8.2 Functional Block Diagram

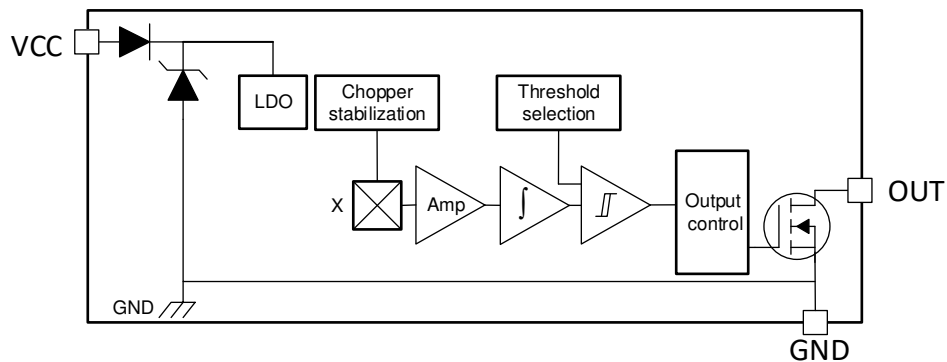

Figure 8-1. Block Diagram

8.3 Feature Description

8.3.1 Field Direction Definition

The TMAG5123-Q1 is sensitive to both south and north poles in the same plane as the die as shown [Figure 8-2](#).



Figure 8-2. Field Direction Definition

8.3.2 Device Output

The TMAG5123-Q1 is featured with an open drain output. In order to generate a two state output, a pull-up resistor needs to be added.

Once the device is powered and with no magnetic field applied to it, the output stays at $V_{out}(H)$. As an omnipolar sensor the output will go down to $V_{out}(L)$ when the field increase beyond the BOP threshold either with a north or a south magnetic field. When the field decrease below the BRP threshold, either with a north or a south magnetic field, the output will go up to $V_{out}(H)$

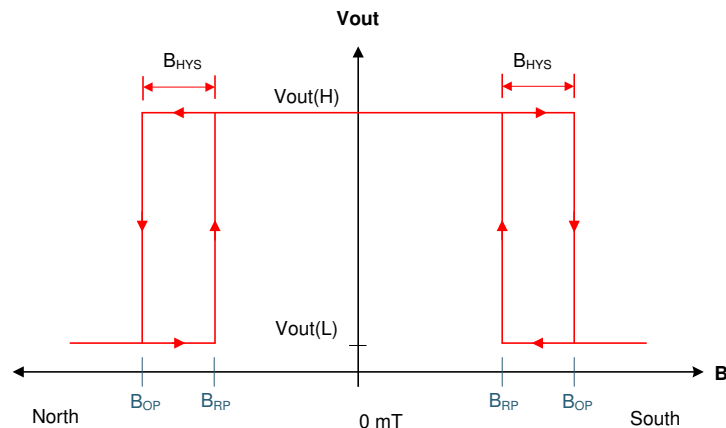

Figure 8-3. Omnipolar Functionality

8.3.3 Protection Circuits

The TMAG5123-Q1 device is protected against load dump and reverse-supply conditions

8.3.3.1 Load Dump Protection

The TMAG5123-Q1 device operates at DC VCC conditions up to 38-V nominally, and can additionally withstand $V_{CC} = 40\text{-V}$. No current-limiting series resistor is required for this protection.

8.3.3.2 Reverse Supply Protection

The TMAG5123-Q1 device is protected in the event that the VCC pin and the GND pin are reversed (up to -20-V).

8.3.4 Hall Element Location

The sensing element inside the device is in the center of both packages when viewed from the top. Figure 8-4 shows the tolerances and side-view dimensions.

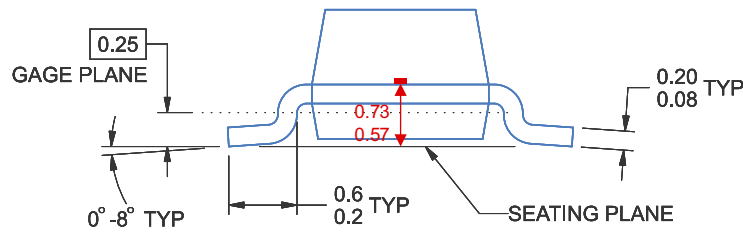
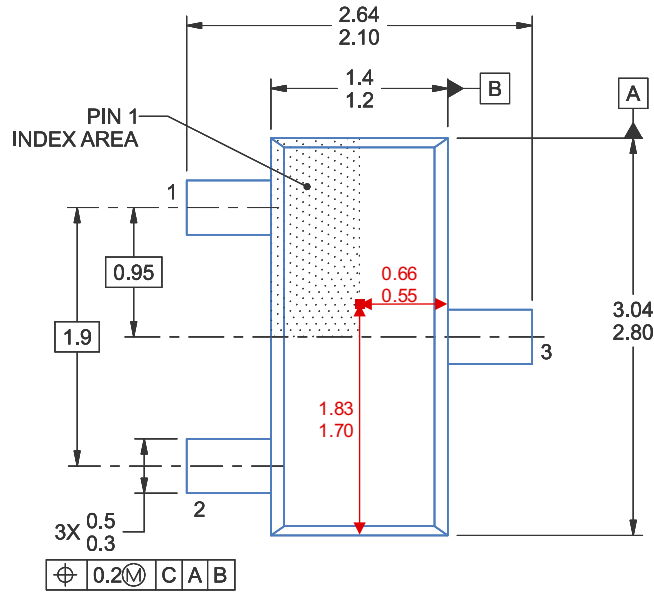

Figure 8-4. Hall Element Location

8.3.5 Power-On Time

Figure 8-5 shows the behavior of the device after the V_{CC} voltage is applied and when the field is below the B_{OP} threshold. Once the minimum value for V_{CC} is reached, the TMAG5123-Q1 will take time t_{ON} to power up and then time t_{PD} to update the output to a level High.

Figure 8-6 shows the behavior of the device after the V_{CC} voltage is applied and when the field is above the B_{OP} threshold. Once the minimum value for V_{CC} is reached, the TMAG5123-Q1 will take time t_{ON} to power up and then time t_{PD} to update the output to a level Low.

The output value during t_{ON} is unknown in both cases. The output value at the end of t_{ON} will be set at High.

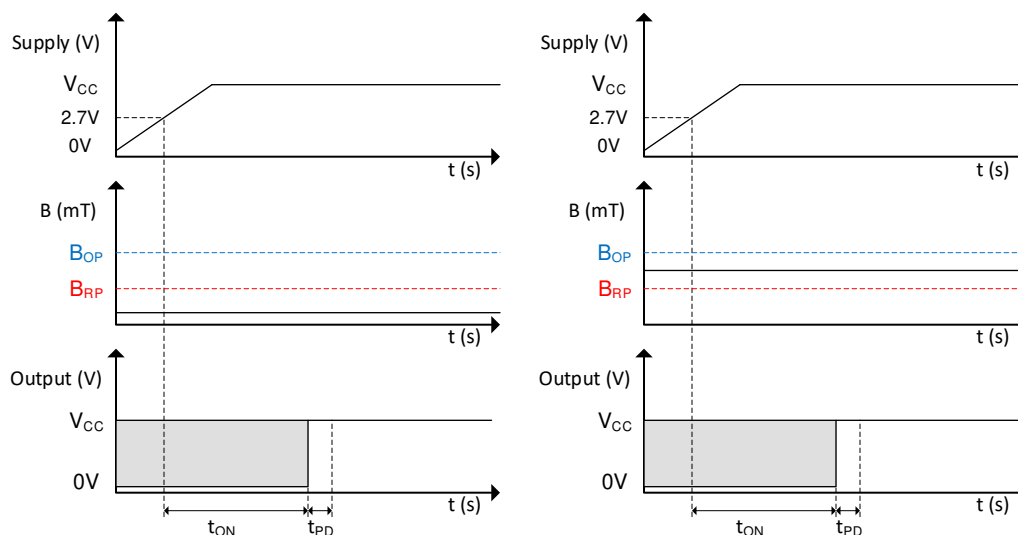

Figure 8-5. Power-On Time When $B < B_{OP}$

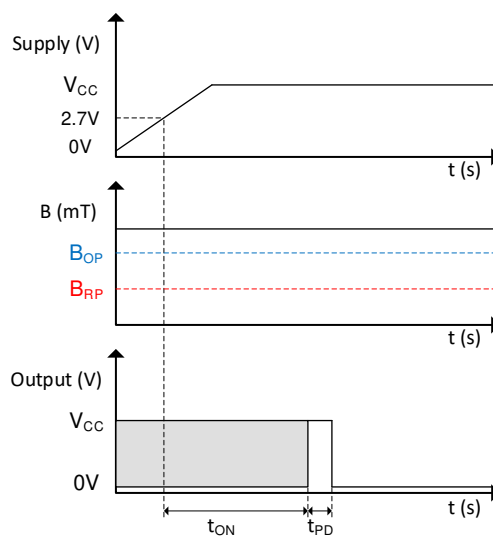

Figure 8-6. Power-On Time When $B > B_{OP}$

8.3.6 Propagation Delay

The TMAG5123-Q1 samples the Hall element at a nominal sampling interval of t_{PD} to detect the presence of a magnetic south or north pole. Between each sampling interval, the device calculates the average magnetic field applied to the device. If this average value crosses the B_{OP} or B_{RP} threshold, the device changes the corresponding level as defined in Figure 8-3. The Hall sensor + magnet system is by nature asynchronous,

therefore the propagation delay (t_{PD}) will vary depending on when the magnetic field goes above the B_{OP} value. As shown in Figure 8-7, the output delay also depends on when the magnetic field goes above the B_{OP} value.

The first graph in Figure 8-7 shows the typical case. The magnetic field goes above the B_{OP} value at the moment the output is updated. The part will only require one sampling period of t_{PD} to update the output.

The second graph in Figure 8-7 shows a magnetic field going above the B_{OP} value just before half of the sampling period. This is the best-case scenario where the output is updated in just half of the sampling period.

Finally, the third graph in Figure 8-7 shows the worst-case scenario where the magnetic field goes above the B_{OP} value just after half of the sampling period. At the next output update, the device will still see the magnetic field under the B_{OP} threshold and will require a whole new sampling period to update the output.

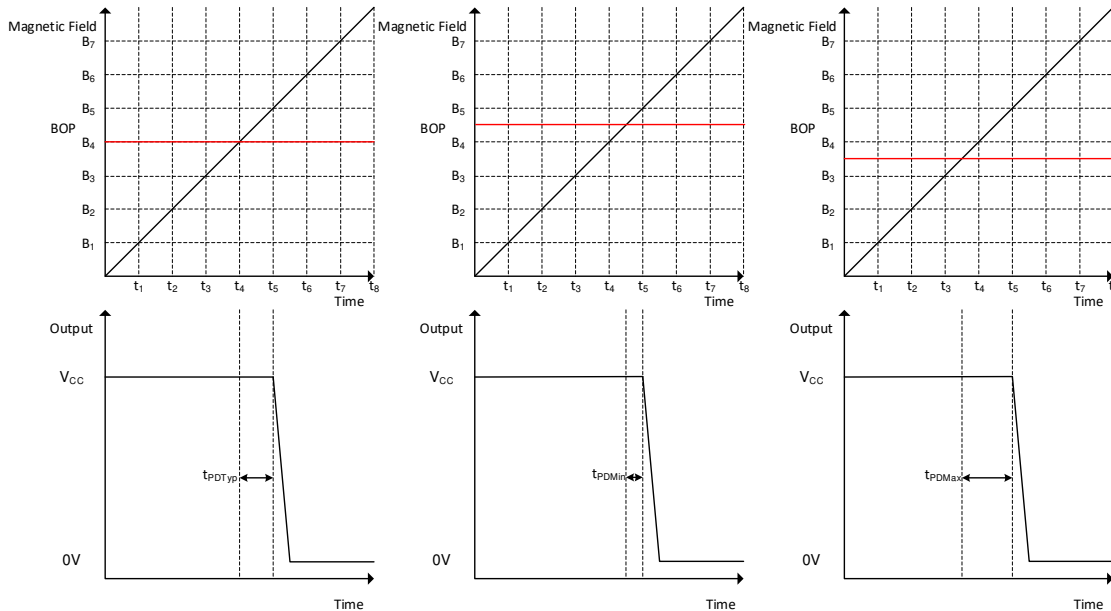

Figure 8-7. Field Sampling Timing

Figure 8-8 shows TMAG5123-Q1 propagation delay analysis when a magnetic south or north pole is applied. The Hall element of the TMAG5123-Q1 experiences an increasing magnetic field as a magnetic south or north pole approaches the device, as well as a decreasing magnetic field as a magnetic south or north pole moves away. At time t_1 , the magnetic field goes above the B_{OP} threshold. The output will then start to move after the propagation delay (t_{PD}). This time will vary depending on when the sampling period is, as shown in Figure 8-7. At t_2 , the output start pulling the output voltage Low. At t_3 , the output is completely pulled down. The same process happens on the other way when the magnetic value is going under the B_{RP} threshold.

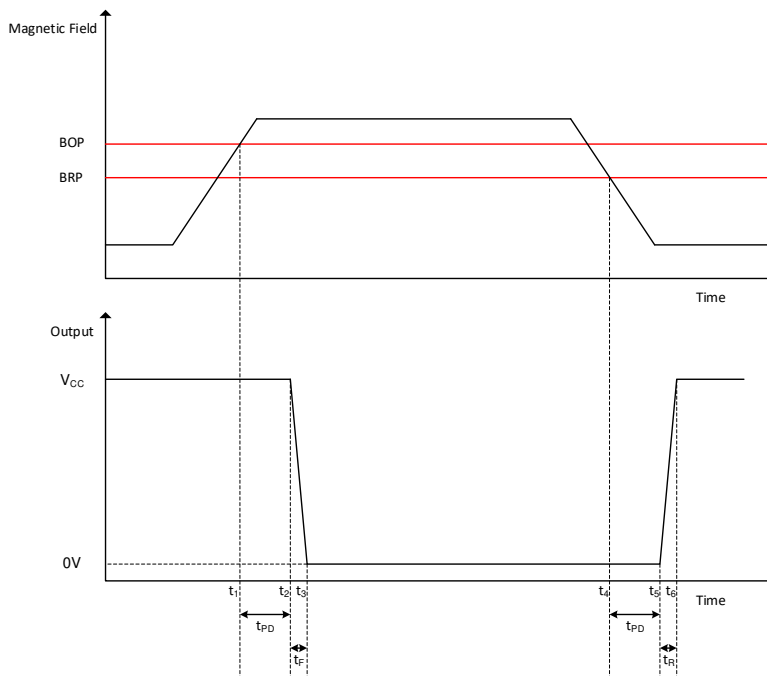

Figure 8-8. Propagation Delay

8.3.7 Chopper Stabilization

The Basic Hall-effect sensor consists of four terminals where a current is injected through two opposite terminals and a voltage is measured through the other opposite terminals. The voltage measured is proportional to the current injected and the magnetic field measured. By knowing the current injected, the device can then know the magnetic field strength. The problem is that the voltage generated is small in amplitude while the offset voltage generated is more significant. To create a precise sensor, the offset voltage must be minimized.

Chopper stabilization is one way to significantly minimize this offset. It is achieved by "spinning" the sensor and sequentially applying the bias current and measuring the voltage for each pair of terminals. This means that a measurement is completed once the spinning cycle is completed. The full cycle is completed after sixteen measurements. The output of the sensor is connected to an amplifier and an integrator that will accumulate and filter out a voltage proportional to the magnetic field present. Finally, a comparator will switch the output if the voltage reaches either the BOP or BRP threshold (depending on which state the output voltage was previously in).

The frequency of each individual measurement is referred to as the Chopping frequency, or f_{CHOP} . The total conversion time is referred to as the Propagation delay time, t_{PD} , and is basically equal to $16/f_{\text{CHOP}}$. Finally, the Signal bandwidth, f_{BW} , represents the maximum value of the magnetic field frequency, and is equal to $(f_{\text{CHOP}}/16)/2$ as defined by the sampling theorem.

8.4 Device Functional Modes

The device operates in only one mode when operated within the [Recommended Operating Conditions](#).

9 Application and Implementation

Note

Information in the following applications sections is not part of the TI component specification, and TI does not warrant its accuracy or completeness. TI's customers are responsible for determining suitability of components for their purposes, as well as validating and testing their design implementation to confirm system functionality.

9.1 Application Information

The TMAG5123-Q1 is typically used in magnetic-field sensing applications to detect the proximity of a magnet that is in the "in-plane" axis from the sensor. The magnet is often attached to a movable component in the system.

The TMAG5123-Q1 is a Hall sensor that implements a Hall sensing element that senses parallel to the package of the part rather than through the z-axis of the device. This eases constraints in system design where a parallel magnetic field is needed to be detected, but normal industry packages, such as TO-92 are undesirable due to space constraints.

9.2 Typical Applications

9.2.1 In-Plane Typical Application Diagrams

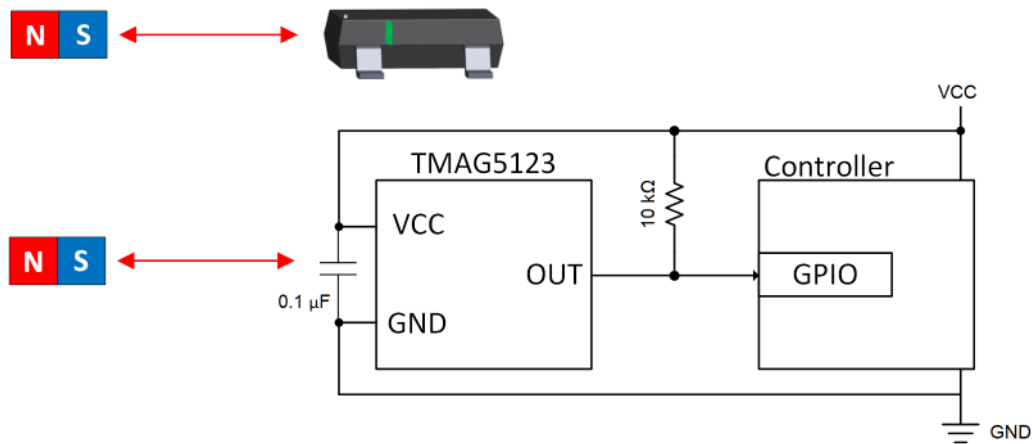

Figure 9-1. Typical In-Plane Sensing Diagram

9.2.1.1 Design Requirements

For this design example, use the parameters listed in one of the 3 tables below depending on which version of the device is used.

Table 9-1. Design Parameters for TMAG5123B-Q1

DESIGN PARAMETER	EXAMPLE VALUE
V _{cc}	12 V
TMAG5123-Q1 Device	TMAG5123B-Q1
Magnet	1-cm Cube NdFeB (N45)
Minimum Magnet Distance to Operate	2.8 cm (± 6 mT) with BOP Max
Maximum Magnet Distance to Release	8.4 cm (± 0.3 mT) with BRP Min

Table 9-2. Design Parameters for TMAG5123C-Q1

DESIGN PARAMETER	EXAMPLE VALUE
V _{cc}	12 V
TMAG5123-Q1 Device	TMAG5123C-Q1
Magnet	1-cm Cube NdFeB (N45)
Minimum Magnet Distance to Operate	2.33 cm (± 9.5 mT) with BOP Max
Maximum Magnet Distance to Release	3.44 cm (± 3.5 mT) with BRP Min

Table 9-3. Design Parameters for TMAG5123D-Q1

DESIGN PARAMETER	EXAMPLE VALUE
V _{cc}	12 V
TMAG5123-Q1 Device	TMAG5123D-Q1
Magnet	1-cm Cube NdFeB (N45)
Minimum Magnet Distance to Operate	2.04 cm (± 13 mT) with BOP Max
Maximum Magnet Distance to Release	2.68 cm (± 6.7 mT) with BRP Min

9.2.1.2 Detailed Design Procedure

When designing a digital-switch magnetic sensing system, three variables should always be considered: the magnet, sensing distance, and threshold of the sensor.

The TMAG5123-Q1 device has a detection threshold specified by parameter B_{OP} , which is the amount of magnetic flux required to pass through the Hall sensor mounted inside the TMAG5123-Q1. To reliably activate the sensor, the magnet must apply a flux greater than the maximum specified B_{OP} . In such a system, the sensor typically detects the magnet before it has moved to the closest position, but designing to the maximum parameter ensures robust turn-on for all possible values of B_{OP} . When the magnet moves away from the sensor, it must apply less than the minimum specified B_{RP} to reliably release the sensor.

Magnets are made from various ferromagnetic materials that have tradeoffs in cost, drift with temperature, absolute maximum temperature ratings, remanence or residual induction (B_r), and coercivity (H_c). The B_r and the dimensions of a magnet determine the magnetic flux density (B) it produces in 3-dimensional space. For simple magnet shapes, such as rectangular blocks and cylinders, there are simple equations that solve B at a given distance centered with the magnet.

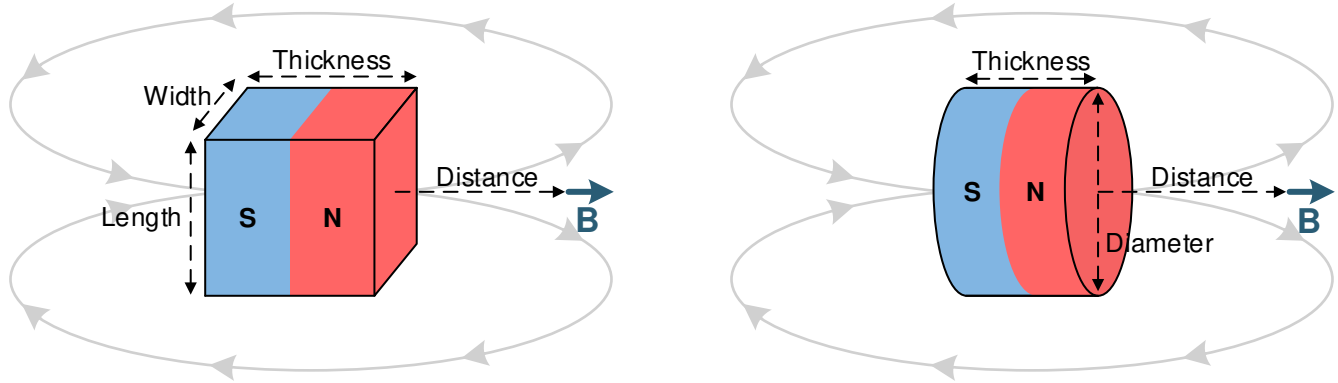

Figure 9-2. Rectangular Block and Cylinder Magnets

Use Equation 1 for the rectangular block shown in Figure 9-2:

$$\vec{B} = \frac{B_r}{\pi} \left(\arctan \left(\frac{WL}{2D\sqrt{4D^2 + W^2 + L^2}} \right) - \arctan \left(\frac{WL}{2(D+T)\sqrt{4(D+T)^2 + W^2 + L^2}} \right) \right) \quad (1)$$

Use Equation 2 for the cylinder shown in Figure 9-2:

$$\vec{B} = \frac{B_r}{2} \left(\frac{D+T}{\sqrt{(0.5C)^2 + (D+T)^2}} - \frac{D}{\sqrt{(0.5C)^2 + D^2}} \right) \quad (2)$$

where

- W is width.
- L is length.
- T is thickness (the direction of magnetization).
- D is distance.
- C is diameter.

An online tool, the *Hall Effect Switch Magnetic Field Calculator*, that uses these formulas is located at .

All magnetic materials generally have a lower B_r at higher temperatures. Systems should have margin to account for this, as well as for mechanical tolerances.

For the TMAG5123B-Q1, the maximum BOP is 4.5 mT. Choosing a 1-cm cube NdFeB N45 magnet, Equation 1 shows that this point occurs at 3.05 cm. This means that, provided the design places the magnet within 3.05 cm from the sensor during a "turnon" event, the magnet will activate the sensor. The removal of the magnet away from the device will ensure a crossing of the minimum BRP point and will return the device to its initial state.

9.2.1.3 Application Curve

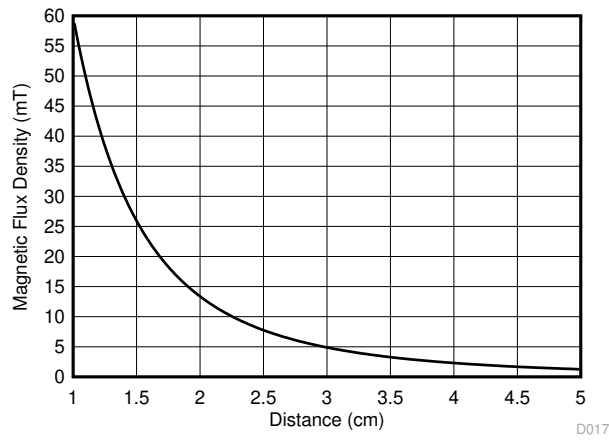

Figure 9-3. Magnetic Profile of a 1-cm Cube NdFeB Magnet

10 Power Supply Recommendations

The TMAG5123-Q1 is powered from 2.7-V to 38-V DC power supplies. A decoupling capacitor close to the device must be used to provide local energy with minimal inductance. TI recommends using a ceramic capacitor with a value of at least 0.01 μF .

11 Layout

11.1 Layout Guidelines

The bypass capacitor should be placed near the TMAG5123-Q1 to reduce noise.

Generally, using PCB copper planes underneath the TMAG5123-Q1 device has no effect on magnetic flux, and does not interfere with device performance. This is because copper is not a ferromagnetic material. However, if nearby system components contain iron or nickel, they may redirect magnetic flux in unpredictable ways.

11.2 Layout Example

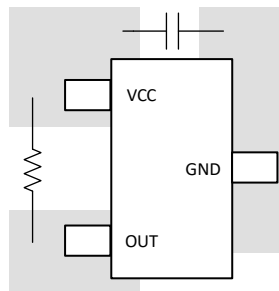

Figure 11-1. TMAG5123-Q1 Layout Example

12 Device and Documentation Support

12.1 Receiving Notification of Documentation Updates

To receive notification of documentation updates, navigate to the device product folder on ti.com. Click on *Subscribe to updates* to register and receive a weekly digest of any product information that has changed. For change details, review the revision history included in any revised document.

12.2 Support Resources

TI E2E™ [support forums](#) are an engineer's go-to source for fast, verified answers and design help — straight from the experts. Search existing answers or ask your own question to get the quick design help you need.

Linked content is provided "AS IS" by the respective contributors. They do not constitute TI specifications and do not necessarily reflect TI's views; see TI's [Terms of Use](#).

12.3 Trademarks

TI E2E™ is a trademark of Texas Instruments.

All trademarks are the property of their respective owners.

12.4 Electrostatic Discharge Caution



This integrated circuit can be damaged by ESD. Texas Instruments recommends that all integrated circuits be handled with appropriate precautions. Failure to observe proper handling and installation procedures can cause damage.

ESD damage can range from subtle performance degradation to complete device failure. Precision integrated circuits may be more susceptible to damage because very small parametric changes could cause the device not to meet its published specifications.

12.5 Glossary

[TI Glossary](#) This glossary lists and explains terms, acronyms, and definitions.

13 Mechanical, Packaging, and Orderable Information

The following pages include mechanical, packaging, and orderable information. This information is the most current data available for the designated devices. This data is subject to change without notice and revision of this document. For browser-based versions of this data sheet, refer to the left-hand navigation.

PACKAGING INFORMATION

Orderable Device	Status (1)	Package Type	Package Drawing	Pins	Package Qty	Eco Plan (2)	Lead finish/ Ball material (6)	MSL Peak Temp (3)	Op Temp (°C)	Device Marking (4/5)	Samples
TMAG5123B1CEDBZRQ1	ACTIVE	SOT-23	DBZ	3	3000	RoHS & Green	SN	Level-3-260C-168 HR	-40 to 150	23BQ	Samples
TMAG5123C1CEDBZRQ1	ACTIVE	SOT-23	DBZ	3	3000	RoHS & Green	SN	Level-3-260C-168 HR	-40 to 150	23CQ	Samples
TMAG5123D1CEDBZRQ1	ACTIVE	SOT-23	DBZ	3	3000	RoHS & Green	SN	Level-3-260C-168 HR	-40 to 150	23DQ	Samples

(1) The marketing status values are defined as follows:

ACTIVE: Product device recommended for new designs.

LIFEBUY: TI has announced that the device will be discontinued, and a lifetime-buy period is in effect.

NRND: Not recommended for new designs. Device is in production to support existing customers, but TI does not recommend using this part in a new design.

PREVIEW: Device has been announced but is not in production. Samples may or may not be available.

OBSOLETE: TI has discontinued the production of the device.

(2) **RoHS:** TI defines "RoHS" to mean semiconductor products that are compliant with the current EU RoHS requirements for all 10 RoHS substances, including the requirement that RoHS substance do not exceed 0.1% by weight in homogeneous materials. Where designed to be soldered at high temperatures, "RoHS" products are suitable for use in specified lead-free processes. TI may reference these types of products as "Pb-Free".

RoHS Exempt: TI defines "RoHS Exempt" to mean products that contain lead but are compliant with EU RoHS pursuant to a specific EU RoHS exemption.

Green: TI defines "Green" to mean the content of Chlorine (Cl) and Bromine (Br) based flame retardants meet JS709B low halogen requirements of <=1000ppm threshold. Antimony trioxide based flame retardants must also meet the <=1000ppm threshold requirement.

(3) MSL, Peak Temp. - The Moisture Sensitivity Level rating according to the JEDEC industry standard classifications, and peak solder temperature.

(4) There may be additional marking, which relates to the logo, the lot trace code information, or the environmental category on the device.

(5) Multiple Device Markings will be inside parentheses. Only one Device Marking contained in parentheses and separated by a "~" will appear on a device. If a line is indented then it is a continuation of the previous line and the two combined represent the entire Device Marking for that device.

(6) Lead finish/Ball material - Orderable Devices may have multiple material finish options. Finish options are separated by a vertical ruled line. Lead finish/Ball material values may wrap to two lines if the finish value exceeds the maximum column width.

Important Information and Disclaimer: The information provided on this page represents TI's knowledge and belief as of the date that it is provided. TI bases its knowledge and belief on information provided by third parties, and makes no representation or warranty as to the accuracy of such information. Efforts are underway to better integrate information from third parties. TI has taken and continues to take reasonable steps to provide representative and accurate information but may not have conducted destructive testing or chemical analysis on incoming materials and chemicals. TI and TI suppliers consider certain information to be proprietary, and thus CAS numbers and other limited information may not be available for release.

In no event shall TI's liability arising out of such information exceed the total purchase price of the TI part(s) at issue in this document sold by TI to Customer on an annual basis.

OTHER QUALIFIED VERSIONS OF TMAG5123-Q1 :

- Catalog : [TMAG5123](#)

NOTE: Qualified Version Definitions:

- Catalog - TI's standard catalog product

TAPE AND REEL INFORMATION

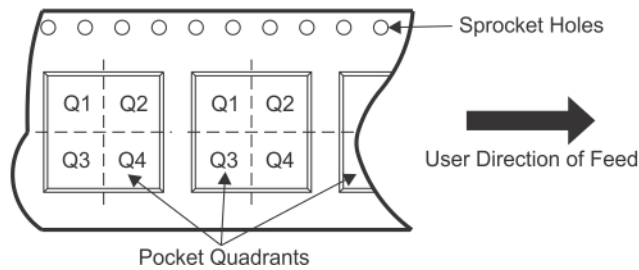
QUADRANT ASSIGNMENTS FOR PIN 1 ORIENTATION IN TAPE

*All dimensions are nominal

Device	Package Type	Package Drawing	Pins	SPQ	Reel Diameter (mm)	Reel Width W1 (mm)	A0 (mm)	B0 (mm)	K0 (mm)	P1 (mm)	W (mm)	Pin1 Quadrant
TMAG5123B1CEDBZRQ1	SOT-23	DBZ	3	3000	178.0	9.0	3.15	2.77	1.22	4.0	8.0	Q3
TMAG5123C1CEDBZRQ1	SOT-23	DBZ	3	3000	178.0	9.0	3.15	2.77	1.22	4.0	8.0	Q3
TMAG5123D1CEDBZRQ1	SOT-23	DBZ	3	3000	178.0	9.0	3.15	2.77	1.22	4.0	8.0	Q3

TAPE AND REEL BOX DIMENSIONS

*All dimensions are nominal

Device	Package Type	Package Drawing	Pins	SPQ	Length (mm)	Width (mm)	Height (mm)
TMAG5123B1CEDBZRQ1	SOT-23	DBZ	3	3000	180.0	180.0	18.0
TMAG5123C1CEDBZRQ1	SOT-23	DBZ	3	3000	180.0	180.0	18.0
TMAG5123D1CEDBZRQ1	SOT-23	DBZ	3	3000	180.0	180.0	18.0

DBZ0003A

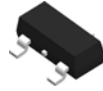

PACKAGE OUTLINE

SOT-23 - 1.12 mm max height

SMALL OUTLINE TRANSISTOR

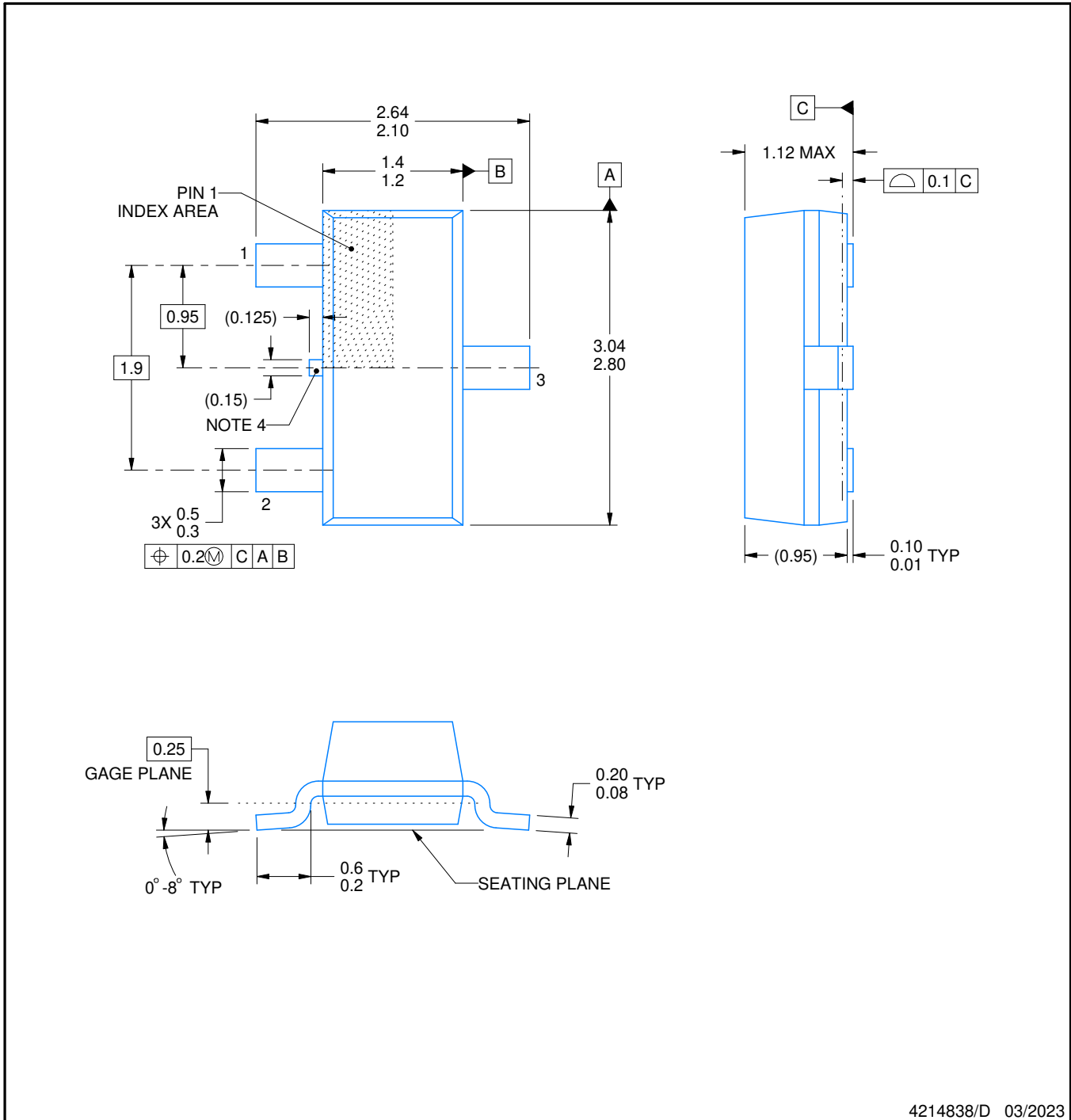

4214838/D 03/2023

NOTES:

1. All linear dimensions are in millimeters. Any dimensions in parenthesis are for reference only. Dimensioning and tolerancing per ASME Y14.5M.
2. This drawing is subject to change without notice.
3. Reference JEDEC registration TO-236, except minimum foot length.
4. Support pin may differ or may not be present.

EXAMPLE BOARD LAYOUT

DBZ0003A

SOT-23 - 1.12 mm max height

SMALL OUTLINE TRANSISTOR

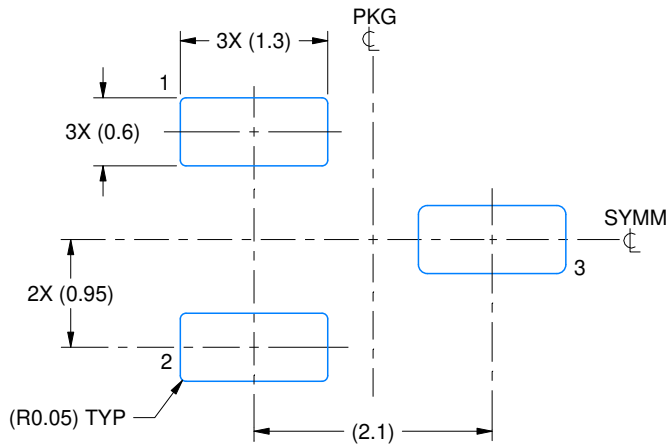

LAND PATTERN EXAMPLE
SCALE:15X

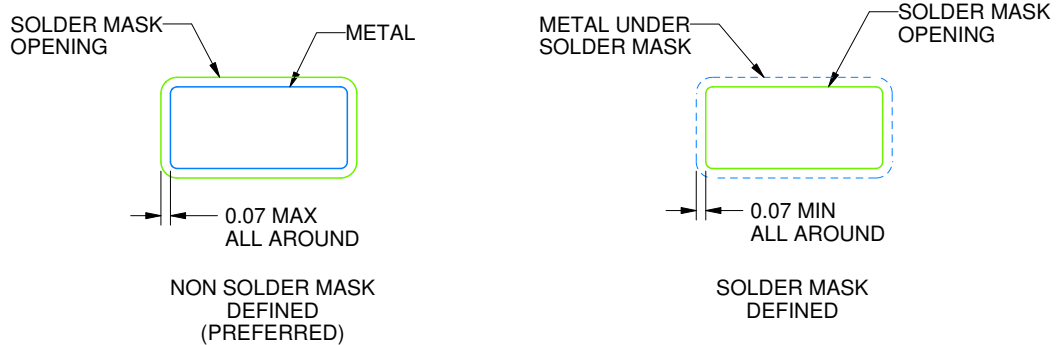

SOLDER MASK DETAILS

4214838/D 03/2023

NOTES: (continued)

4. Publication IPC-7351 may have alternate designs.
5. Solder mask tolerances between and around signal pads can vary based on board fabrication site.

EXAMPLE STENCIL DESIGN

DBZ0003A

SOT-23 - 1.12 mm max height

SMALL OUTLINE TRANSISTOR

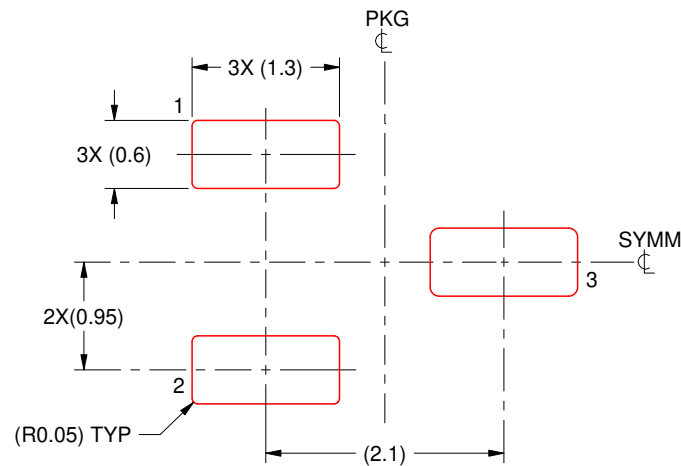

SOLDER PASTE EXAMPLE
BASED ON 0.125 THICK STENCIL
SCALE:15X

4214838/D 03/2023

NOTES: (continued)

6. Laser cutting apertures with trapezoidal walls and rounded corners may offer better paste release. IPC-7525 may have alternate design recommendations.
7. Board assembly site may have different recommendations for stencil design.

IMPORTANT NOTICE AND DISCLAIMER

TI PROVIDES TECHNICAL AND RELIABILITY DATA (INCLUDING DATA SHEETS), DESIGN RESOURCES (INCLUDING REFERENCE DESIGNS), APPLICATION OR OTHER DESIGN ADVICE, WEB TOOLS, SAFETY INFORMATION, AND OTHER RESOURCES "AS IS" AND WITH ALL FAULTS, AND DISCLAIMS ALL WARRANTIES, EXPRESS AND IMPLIED, INCLUDING WITHOUT LIMITATION ANY IMPLIED WARRANTIES OF MERCHANTABILITY, FITNESS FOR A PARTICULAR PURPOSE OR NON-INFRINGEMENT OF THIRD PARTY INTELLECTUAL PROPERTY RIGHTS.

These resources are intended for skilled developers designing with TI products. You are solely responsible for (1) selecting the appropriate TI products for your application, (2) designing, validating and testing your application, and (3) ensuring your application meets applicable standards, and any other safety, security, regulatory or other requirements.

These resources are subject to change without notice. TI grants you permission to use these resources only for development of an application that uses the TI products described in the resource. Other reproduction and display of these resources is prohibited. No license is granted to any other TI intellectual property right or to any third party intellectual property right. TI disclaims responsibility for, and you will fully indemnify TI and its representatives against, any claims, damages, costs, losses, and liabilities arising out of your use of these resources.

TI's products are provided subject to [TI's Terms of Sale](#) or other applicable terms available either on [ti.com](https://www.ti.com) or provided in conjunction with such TI products. TI's provision of these resources does not expand or otherwise alter TI's applicable warranties or warranty disclaimers for TI products.

TI objects to and rejects any additional or different terms you may have proposed.

Mailing Address: Texas Instruments, Post Office Box 655303, Dallas, Texas 75265
Copyright © 2023, Texas Instruments Incorporated