

3-646445-0 ✓ ACTIVE

Z-PACK | Z-PACK 2mm HM

TE Internal #: 3-646445-0

Hard Metric Backplane Connectors, PCB Mount Receptacle, 1 Gb/s, 25 Column, 8 Row, Traditional Backplane, 200 Position, Z-PACK 2mm HM

[View on TE.com >](#)



[Connectors >](#) [PCB Connectors >](#) [Backplane Connectors >](#) [Hard Metric Backplane Connectors >](#)

Hard Metric Backplane Receptacle Connector: Mezzanine, 2mm

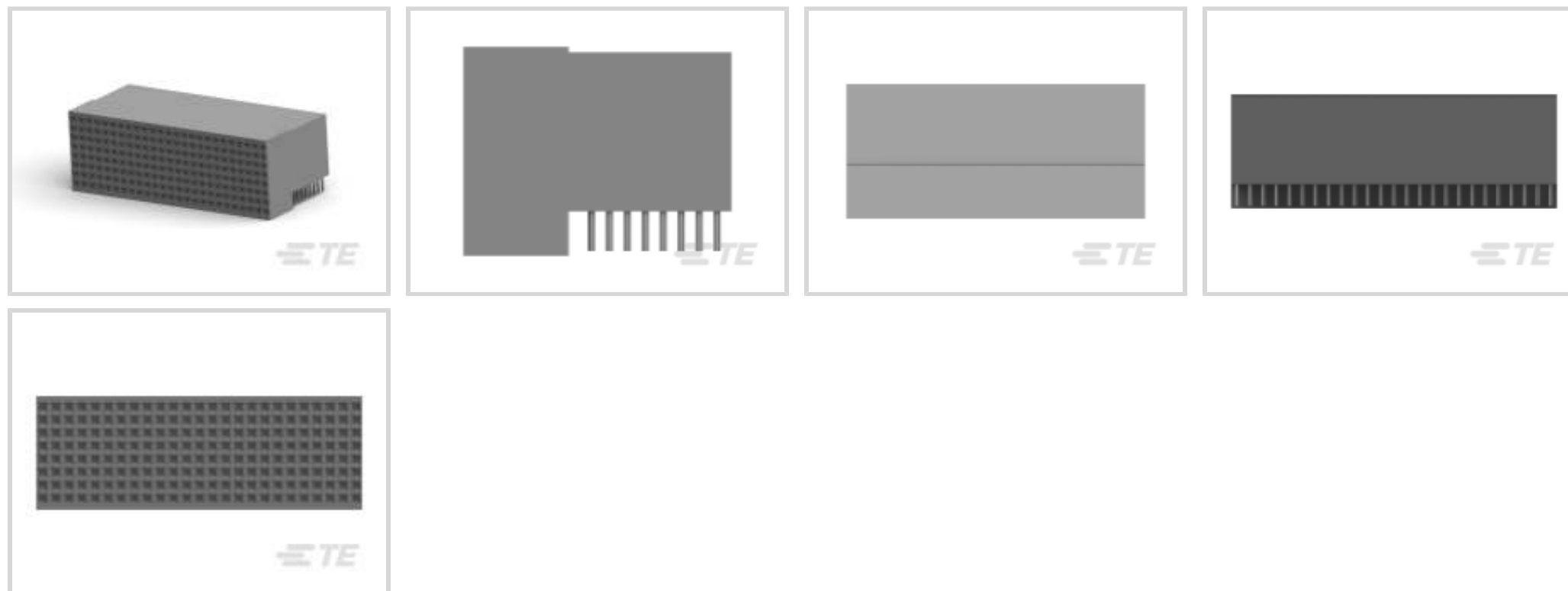

PCB Connector Assembly Type: **PCB Mount Receptacle**

Data Rate: **1 Gb/s**

Number of Columns: **25**

Number of Rows: **8**

Backplane Architecture: **Traditional Backplane**

[All Hard Metric Backplane Receptacle Connector: Mezzanine, 2mm \(27\)](#)

Features

Product Type Features

PCB Connector Assembly Type	PCB Mount Receptacle
Connector System	Board-to-Board
Sealable	No
Connector & Contact Terminates To	Printed Circuit Board

Configuration Features

Number of Columns	25
Number of Rows	8
Backplane Architecture	Traditional Backplane
Number of Positions	200
PCB Mount Orientation	Right Angle

Signal Characteristics

Data Rate	1 Gb/s
-----------	--------

Body Features

Primary Product Color	Gray
-----------------------	------

Contact Features

CompactPCI Designation	None
Contact Type	Socket
Contact Mating Area Plating Material	Gold
Contact Mating Area Plating Material Thickness	.76 μm [30 μin]
Contact Current Rating (Max)	1.5 A

Mechanical Attachment

Connector Mounting Type	Board Mount
-------------------------	-------------

Housing Features

Centerline (Pitch)	2 mm[.07 in]
--------------------	--------------

Usage Conditions

Operating Temperature Range	-55 – 125 $^{\circ}\text{C}$ [-67 – 257 $^{\circ}\text{F}$]
-----------------------------	--

Operation/Application

Circuit Application	Signal
---------------------	--------

Packaging Features

Packaging Method	Tube
------------------	------

Product Compliance

[For compliance documentation, visit the product page on TE.com>](#)

EU RoHS Directive 2011/65/EU	Not Compliant
EU ELV Directive 2000/53/EC	Compliant with Exemptions
China RoHS 2 Directive MIIT Order No 32, 2016	Restricted Materials Above Threshold
EU REACH Regulation (EC) No. 1907/2006	Current ECHA Candidate List: JUNE 2023 (235) Candidate List Declared Against: JUNE 2023 (235) SVHC > Threshold: Pb (13% in Component Part) Article Safe Usage Statements: Do not eat, drink or smoke when using this product. Wash thoroughly after handling. Recycle if possible and dispose of the article by following all applicable governmental regulations relevant to your geographic location.
Halogen Content	Not Low Halogen - contains Br or Cl > 900 ppm.

Solder Process Capability

Not applicable for solder process capability

Product Compliance Disclaimer

This information is provided based on reasonable inquiry of our suppliers and represents our current actual knowledge based on the information they provided. This information is subject to change. The part numbers that TE has identified as EU RoHS compliant have a maximum concentration of 0.1% by weight in homogenous materials for lead, hexavalent chromium, mercury, PBB, PBDE, DBP, BBP, DEHP, DIBP, and 0.01% for cadmium, or qualify for an exemption to these limits as defined in the Annexes of Directive 2011/65/EU (RoHS2). Finished electrical and electronic equipment products will be CE marked as required by Directive 2011/65/EU. Components may not be CE marked. Additionally, the part numbers that TE has identified as EU ELV compliant have a maximum concentration of 0.1% by weight in homogenous materials for lead, hexavalent chromium, and mercury, and 0.01% for cadmium, or qualify for an exemption to these limits as defined in the Annexes of Directive 2000/53/EC (ELV). Regarding the REACH Regulation, the information TE provides on SVHC in articles for this part number is based on the latest European Chemicals Agency (ECHA) 'Guidance on requirements for substances in articles' posted at this URL: <https://echa.europa.eu/guidance-documents/guidance-on-reach>

Compatible Parts



Also in the Series | Z-PACK 2mm HM

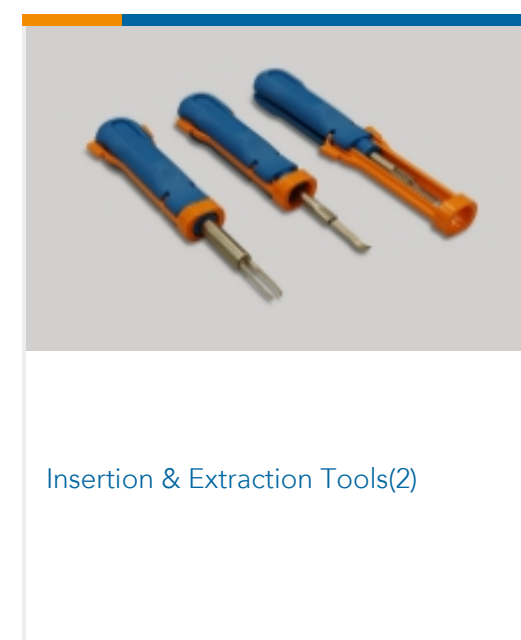
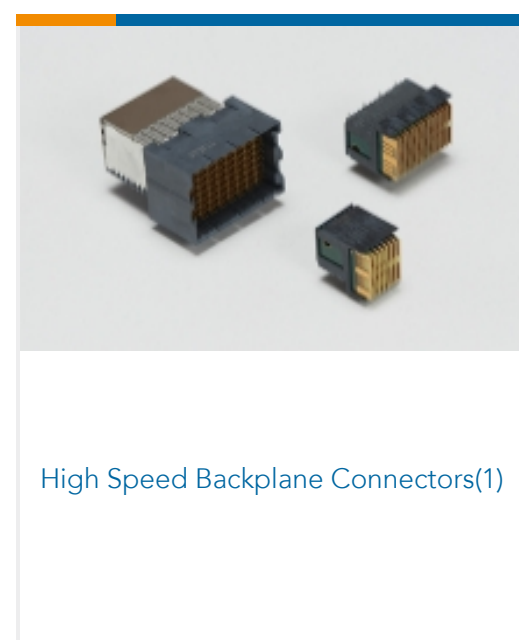
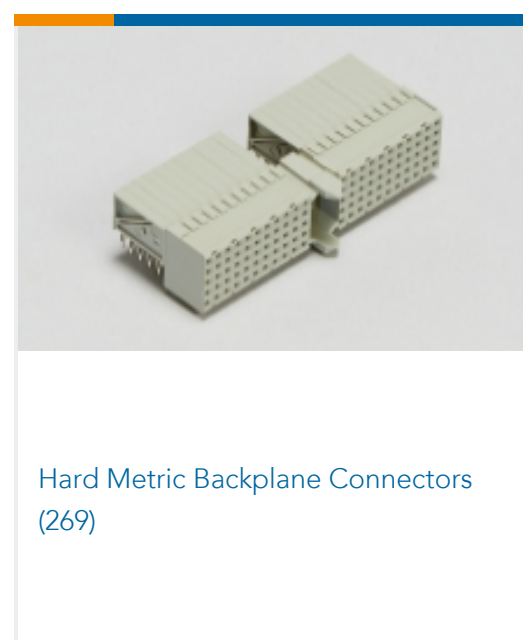
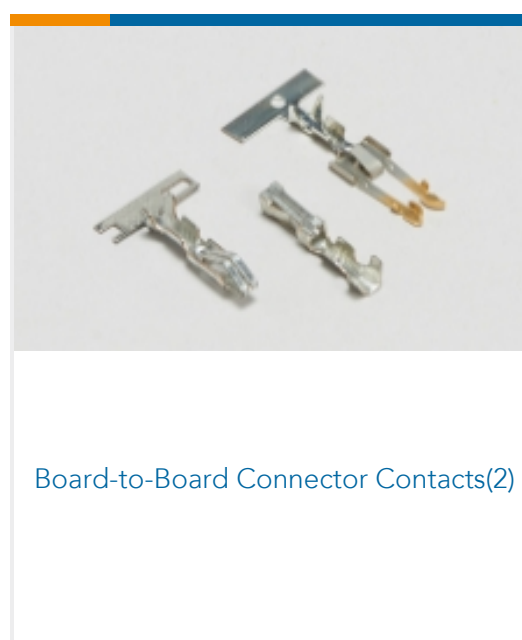
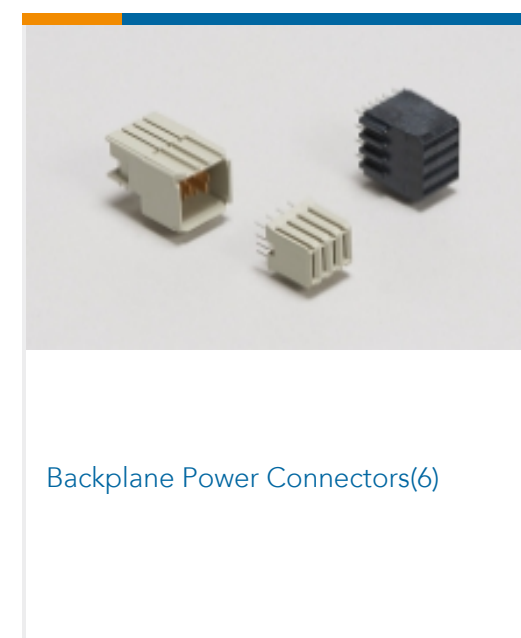
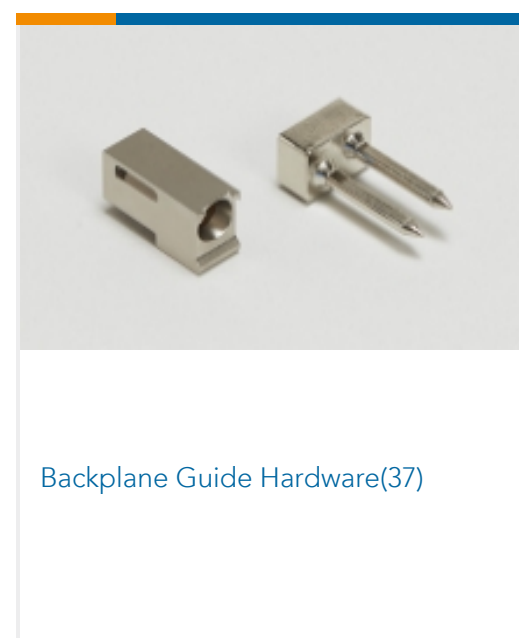
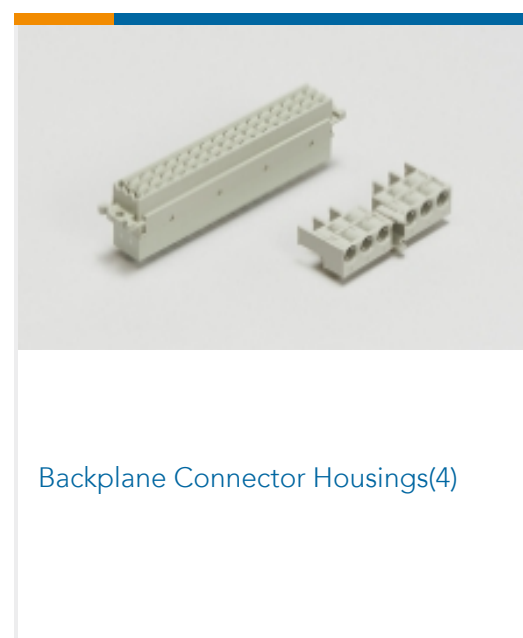
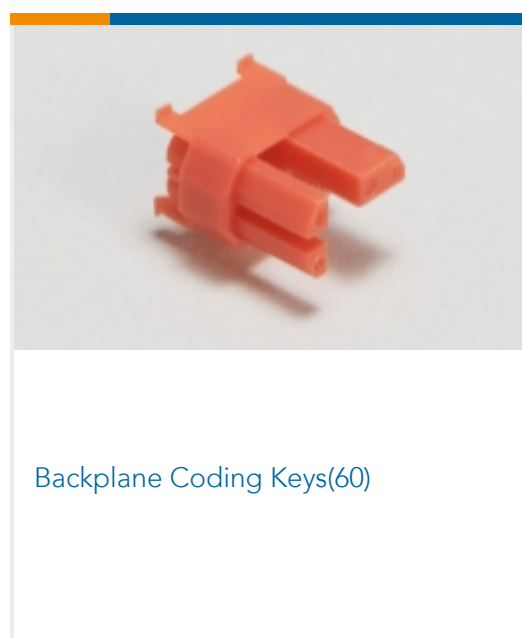

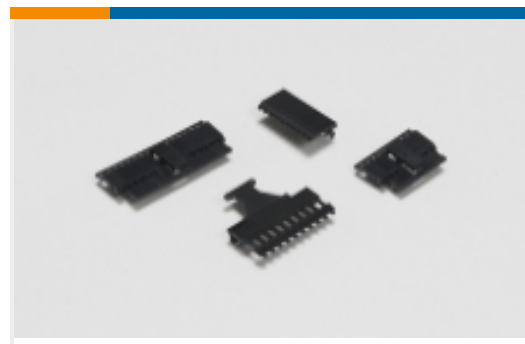

PCB Connector Covers(4)

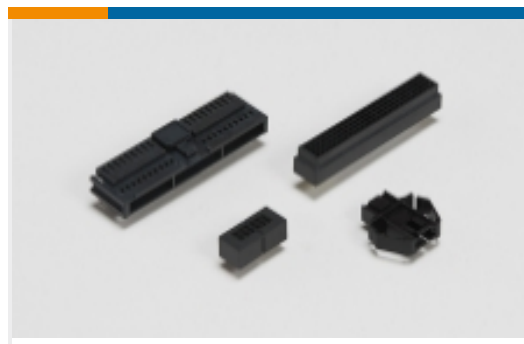

PCB Connector Shrouds(39)



PCB Ferrules & Shields(19)



Rectangular Power Connectors(87)

Customers Also Bought



TE Part #YDTS26T13-04PNV001
PLUG ASSY



TE Part #YDTS26T13-35SNV001
PLUG ASSY



TE Part #YDTS26T19-35PAV001
PLUG ASSY



TE Part #YDTS20T17-06PCV001
RECP ASSY



TE Part #YDTS26T09-98SAV001
PLUG ASSY



TE Part #YDTS26T17-06SAV001
D38999: Straight Plug, 17-06 Insert



TE Part #YDTS26T17-26SNV001
PLUG ASSY



TE Part #YDTS26T25-35SNV001
PLUG ASSY

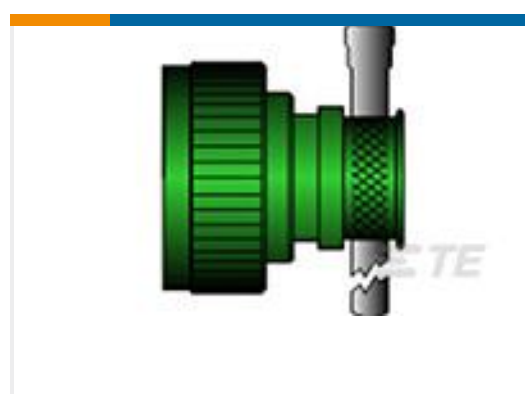

TE Part #CW4574-000
R85049/85-12N02

Documents

Product Drawings

[2MM HM,ASY,T-E,REC,TWIST TULIP](#)

English

CAD Files

[3D PDF](#)

[3D](#)

[Customer View Model](#)

[ENG_CVM_CVM_3-646445-0_P.2d_dxf.zip](#)



English

Customer View Model

[ENG_CVM_CVM_3-646445-0_P.3d_igs.zip](#)

English

Customer View Model

[ENG_CVM_CVM_3-646445-0_P.3d_stp.zip](#)

English

By downloading the CAD file I accept and agree to the [Terms and Conditions](#) of use.

Product Specifications

[Application Specification](#)

English

Product Environmental Compliance

[Product Compliance](#)

English

[Product Compliance](#)

English