

POWER MANAGEMENT

Description

The SC1548 is a power supply controller designed to provide a simple single regulated power supply with over current protection. It is part of Semtech's SmartLDO™ family of products. The SC1548 can provide a 1.818V power supply for the I/O plane or 1.515V for GTL+ / AGP from either 3.3V or 2.5V. An adjustable option allows generation and control of any voltage from 1.263V up to 5V.

SC1548 features include tight output voltage regulation, an enable control and over current protection. Over current protection is provided by feedback to the sense pin. If the output drops below 50% of the nominal output voltage (typical) for greater than 4ms (typical), the output will be shut down.

The SC1548 is available in a tiny 5-pin SOT-23 surface mount package.

Features

- ◆ ± 2.5% output accuracy over line, load and temperature
- ◆ 1.515V, 1.818V and adjustable output voltage options available
- ◆ Enable control
- ◆ Over current protection
- ◆ 5-pin SOT-23 package

Applications

- ◆ Motherboards
- ◆ Graphics cards
- ◆ Microcontrollers
- ◆ Simple power supplies

Typical Application Circuit

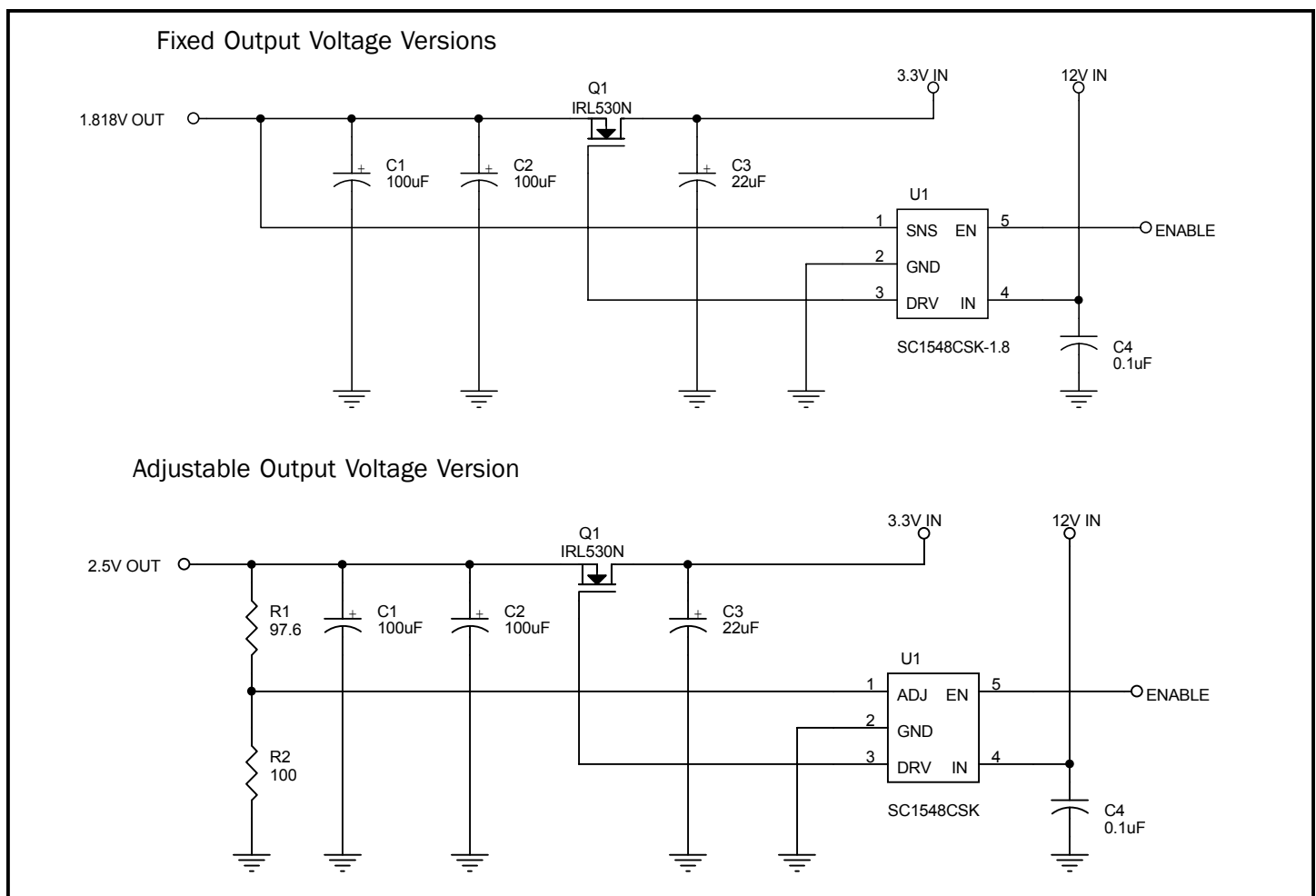

POWER MANAGEMENT
Absolute Maximum Ratings

Exceeding the specifications below may result in permanent damage to the device, or device malfunction. Operation outside of the parameters specified in the Electrical Characteristics section is not implied. Exposure to Absolute Maximum rated conditions for extended periods of time may affect device reliability.

Parameter	Symbol	Maximum	Units
Input Supply Voltage	V_{IN}	-0.5 to +15	V
Input Pins	V_{ADJ} , V_{EN} , V_{SNS}	-0.5 to +7	V
Thermal Impedance Junction to Case	θ_{JC}	81	°C/W
Thermal Impedance Junction to Ambient	θ_{JA}	256	°C/W
Operating Ambient Temperature Range	T_A	0 to +70	°C
Operating Junction Temperature Range	T_J	0 to +125	°C
Storage Temperature Range	T_{STG}	-65 to +150	°C
Lead Temperature (Soldering) 10 Sec	T_{LEAD}	300	°C

Electrical Characteristics⁽¹⁾

Unless specified: $T_A = 25^\circ\text{C}$, $V_{IN} = 12\text{V}$, $V_{PWR} = 3.3\text{V}$, $I_{OUT} = 0\text{A}$. Values in **bold** apply over full operating temperature range.

Parameter	Symbol	Test Conditions	Min	Typ	Max	Units
IN						
Supply Voltage	V_{IN}		11.28	12.00	12.72	V
Quiescent Current	I_Q			1.0	1.5	mA
					2.0	
Undervoltage Lockout						
Start Threshold	UVLO		7	8	9	V
EN						
Enable Pin Current	I_{EN}	$V_{EN} = 0\text{V}$		100	150	μA
Threshold Voltage	$V_{TH(EN)}$	V_{EN} rising	1.8		2.3	V
Hysteresis	V_{HYST}			200		mV
Enable Delay Time ⁽²⁾⁽³⁾	$t_{D(ON)}$	$V_{EN} = \text{Low to High}$, measured from $V_{EN} = V_{TH(EN)}$ to 10% V_{DRV}		500		ns
Disable Delay Time ⁽²⁾⁽³⁾	$t_{D(OFF)}$	$V_{EN} = \text{High to Low}$, measured from $V_{EN} = V_{TH(EN)}$ to 90% V_{DRV}		150		ns
SNS (Fixed Output Voltage Parts)						
Sense Pin Current	I_{SNS}	Sinking	75	100	125	μA
ADJ (Adjustable Output Voltage Parts)						
Adjust Pin Current	I_{ADJ}	Sourcing		0.25		μA
Reference Voltage ⁽²⁾	V_{ADJ}	$3.0\text{V} \leq V_{PWR}^{(4)} \leq 3.6\text{V}$, $1\text{mA} \leq I_{OUT} \leq 1\text{A}$	-1.5%	1.263	+1.5%	V
			-2.5%		+2.5%	

POWER MANAGEMENT
Electrical Characteristics (Cont.)⁽¹⁾

Unless specified: $T_A = 25^\circ\text{C}$, $V_{IN} = 12\text{V}$, $V_{PWR} = 3.3\text{V}$, $I_{OUT} = 0\text{A}$. Values in **bold** apply over full operating temperature range.

Parameter	Symbol	Test Conditions	Min	Typ	Max	Units
Output Voltage Regulation (Fixed Output Voltage Parts)						
Output Voltage ⁽²⁾	V_{OUT}	$3.0\text{V} \leq V_{PWR}^{(4)} \leq 3.6\text{V}$, $1\text{mA} \leq I_{OUT} \leq 1\text{A}$	-1.5%	V_{OUT}	+1.5%	V
			-2.5%		+2.5%	
DRV						
Output Current	I_{DRV}	$V_{DRV} = 4\text{V}$, $V_{SNS} = 1.2\text{V}$	5	10		mA
Output Voltage	V_{DRV}	Full On, $I_{DRV} = 0\text{mA}$	9.0	10.5		V
Rise Time ⁽²⁾⁽³⁾	t_r	$V_{EN} = \text{Low to High}$, measured from $V_{EN} = V_{TH(EN)}$ to 90% V_{DRV}		1.0		ms
Fall Time ⁽²⁾⁽³⁾	t_f	$V_{EN} = \text{High to Low}$, measured from $V_{EN} = V_{TH(EN)}$ to 10% V_{DRV}		550		μs
Overcurrent Protection						
Trip Threshold	$V_{TH(OC)}$		30	50	70	% V_{OUT}
Power-up Output Short Circuit Immunity			1	5	60	ms
Output Short Circuit Glitch Immunity			0.5	4	30	ms
Control Section						
Bandwidth		$V_{DRV} = 9\text{V}$, THD = 5%, $C_L = 600\text{pF}$		5		MHz

Notes:

- (1) This device is ESD sensitive. Use of standard ESD handling precautions is required.
- (2) See Application Circuit on page 1.
- (3) See Timing Diagram on page 4.
- (4) Connected to FET drain.

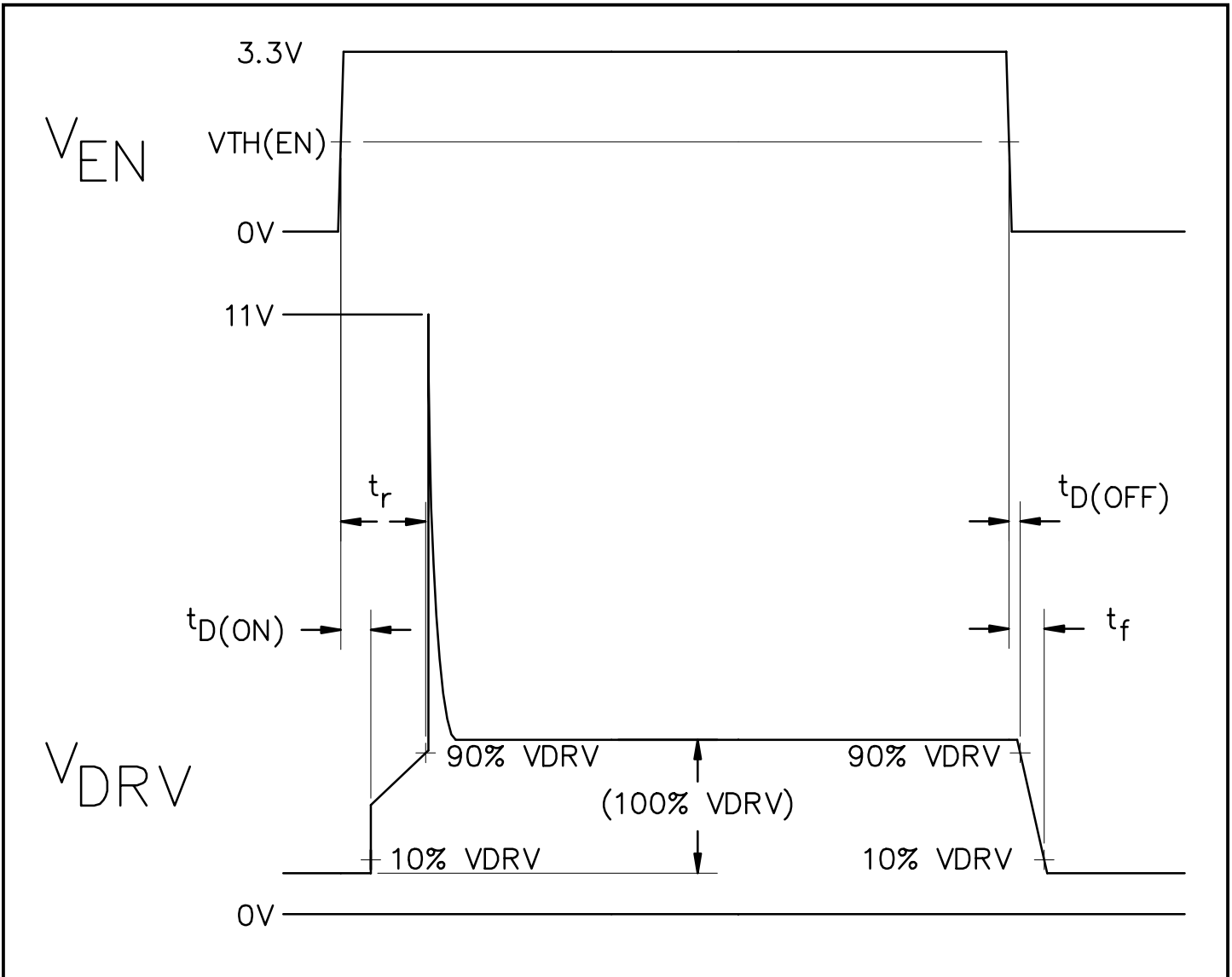

POWER MANAGEMENT

Pin Configuration

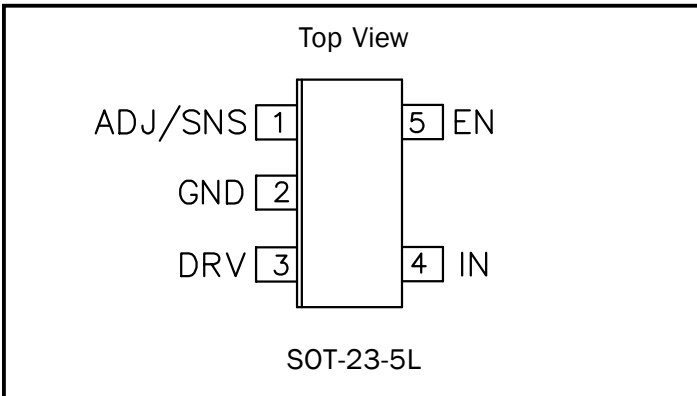

Ordering Information

Part Number ⁽¹⁾⁽²⁾	Package
SC1548CSK-X.XTR	SOT-23-5
SC1548CSKTRT ⁽³⁾	

Notes:

- (1) Where -X.X denotes voltage options. Available voltages are: 1.515V (-1.5) and 1.818V (-1.8). Leave blank for adjustable version.
- (2) Only available in tape and reel packaging. A reel contains 3000 units.
- (3) Lead free product. This product is fully WEEE and RoHS compliant.

Block Diagram

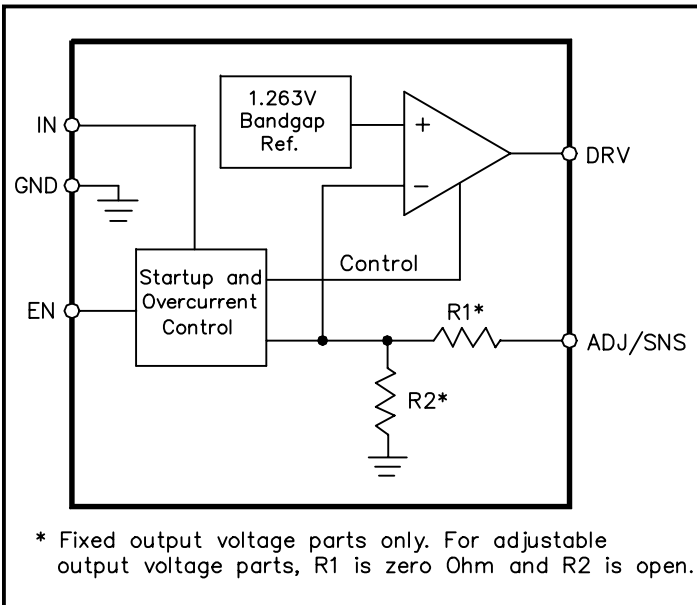

Pin Descriptions

Pin	Pin Name	Pin Function
1	SNS	Regulator sense input for fixed output voltage options. Use as a remote sense to the source of the N-channel MOSFET.
	ADJ	Regulator sense input for adjustable output voltage version. Set output voltage as follows (refer to application circuit on page 1): $VO = 1.263 \cdot \left(1 + \frac{R1}{R2}\right)$
2	GND	Ground.
3	DRV	Output of regulator. Drives the gate of an N-channel MOSFET to maintain the output voltage desired.
4	IN	+12V supply.
5	EN	Active high enable control with internal pullup. Output of regulator turns off when EN is taken low.

POWER MANAGEMENT

Typical Characteristics⁽¹⁾

Quiescent Current vs. Junction Temperature

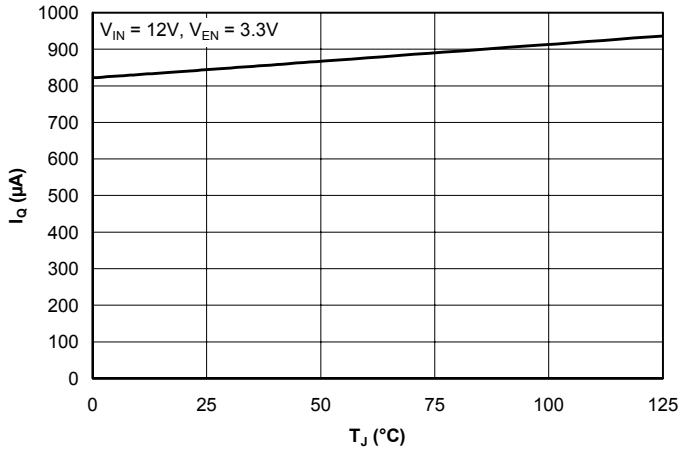

Start Threshold vs. Junction Temperature

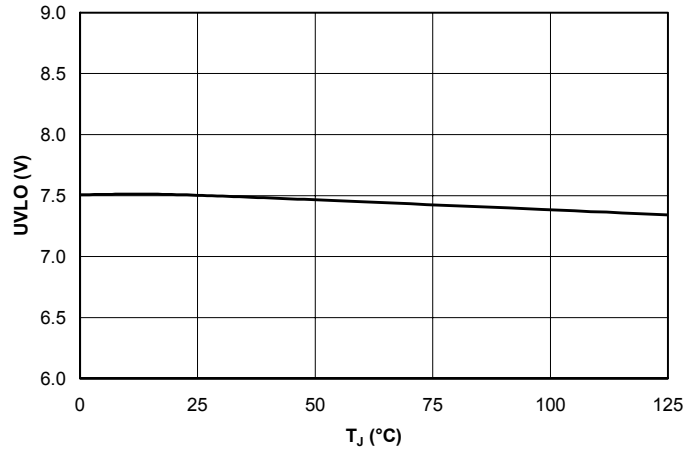

Enable Threshold Voltage vs. Junction Temperature

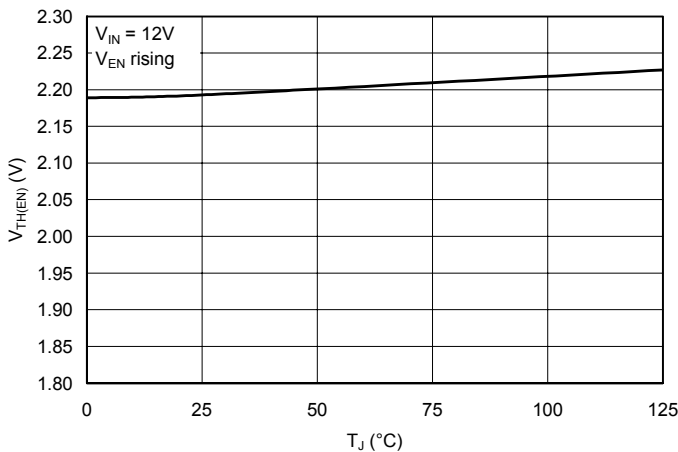

Enable Hysteresis vs. Junction Temperature

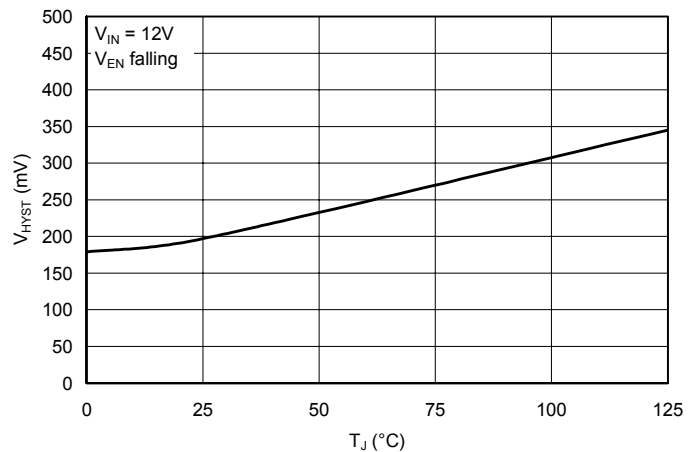

Enable Pin Current vs. Junction Temperature

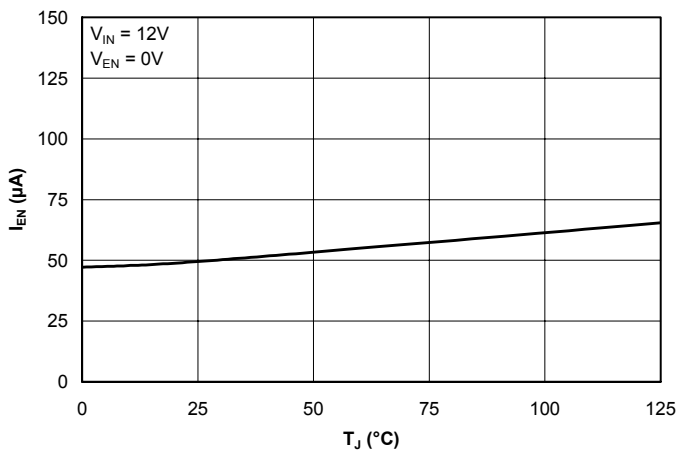

Enable Delay Time vs. Junction Temperature

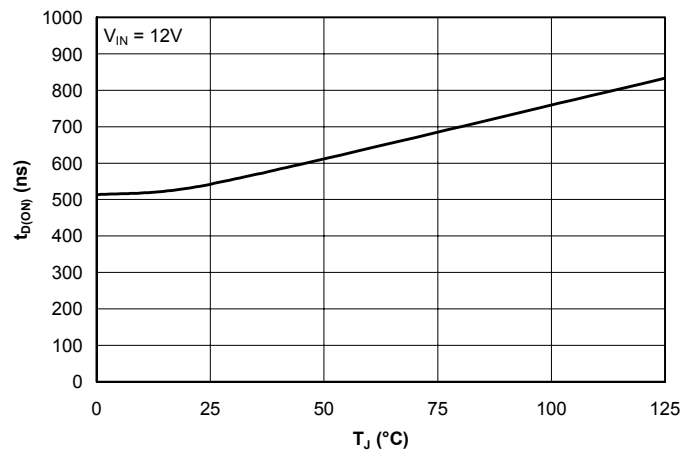

POWER MANAGEMENT

Typical Characteristics (Cont.)⁽¹⁾

Disable Delay Time vs. Junction Temperature

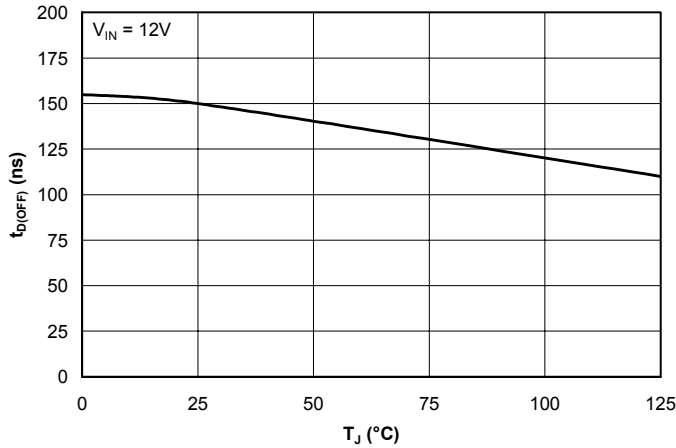

Sense Pin Current vs. Junction Temperature

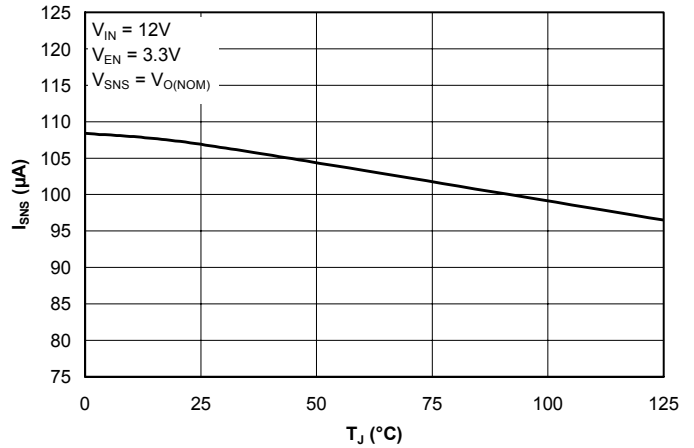

Drive Output Voltage vs. Junction Temperature

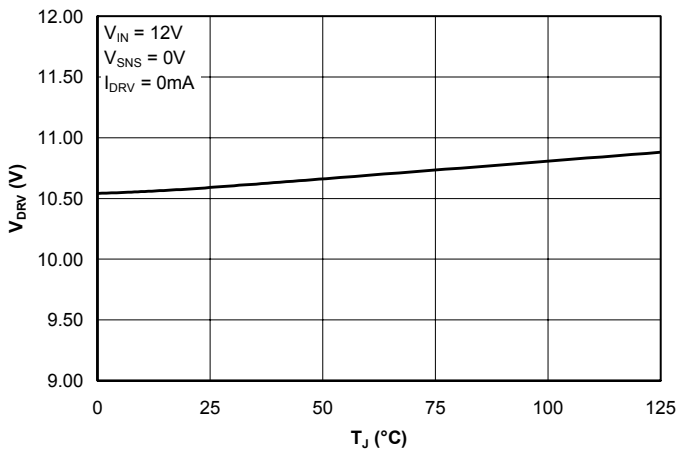

Output Voltage (SC1548CSK-1.8) vs. Junction Temperature

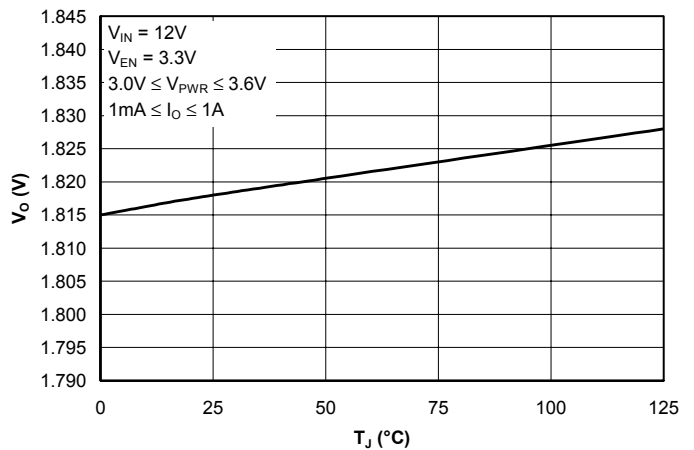

OCP Trip Threshold (SC1548CSK-1.8) vs. Junction Temperature

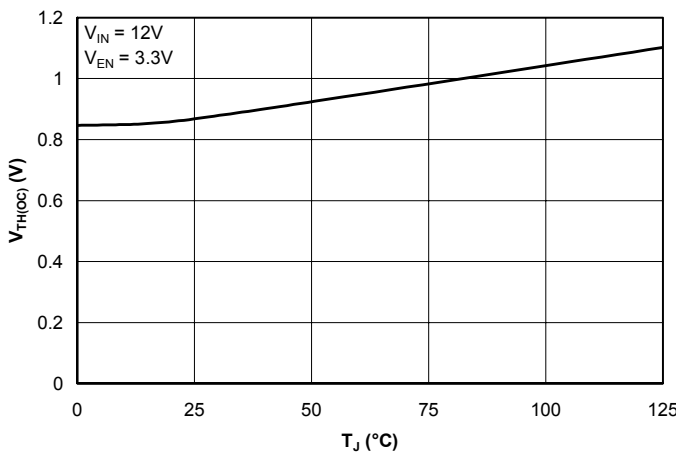

Power-Up Output Short Circuit Immunity vs. Junction Temperature

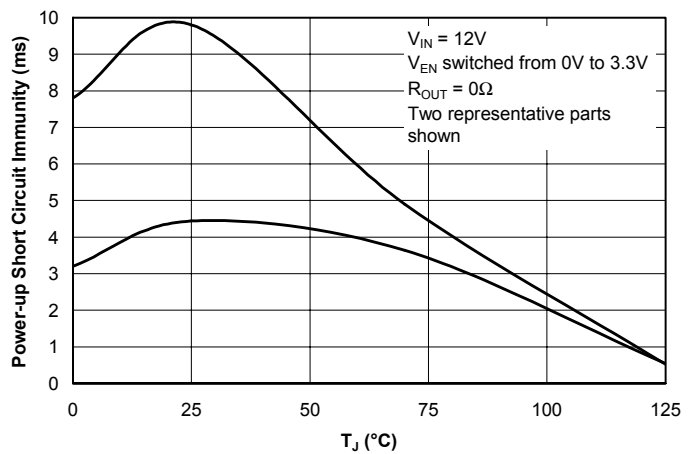

Output Short Circuit Glitch Immunity vs. Junction Temperature

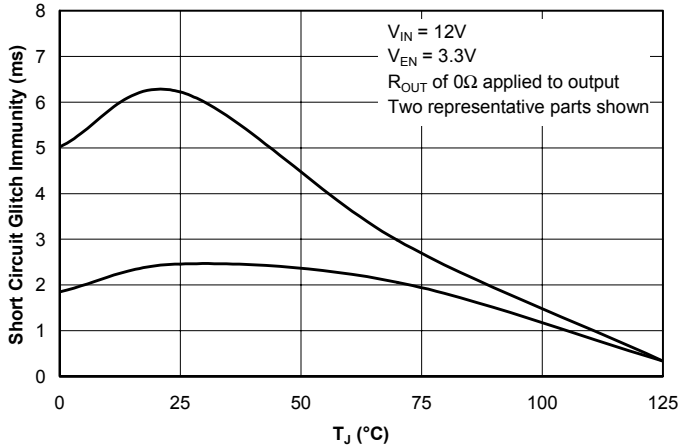

Drive Pin Rise Time vs. Junction Temperature

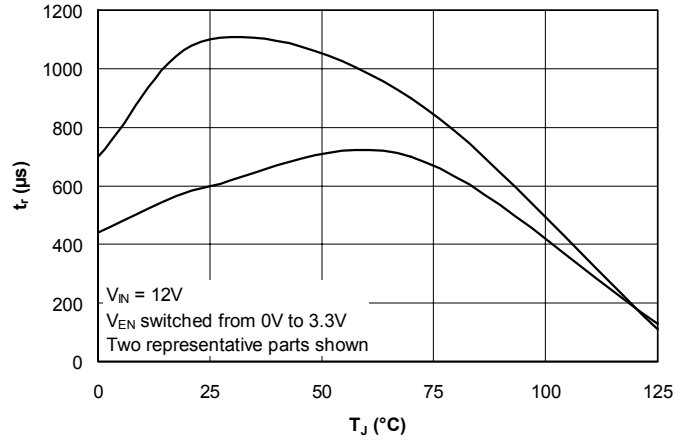

Drive Pin Fall Time vs. Junction Temperature

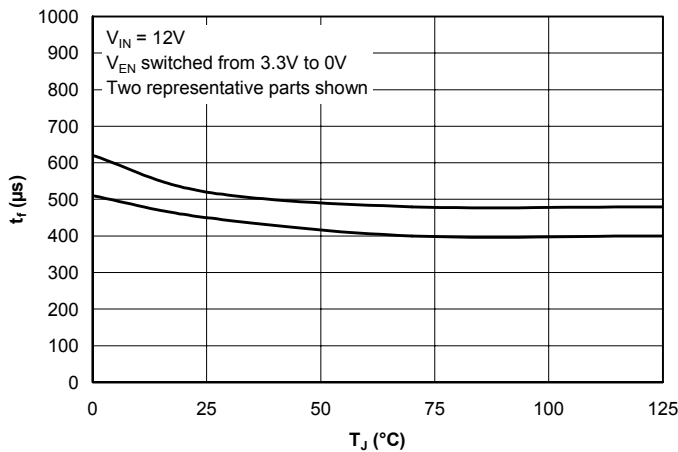

SC1548CSK-1.8 Small Signal Gain and Phase Shift vs. Frequency

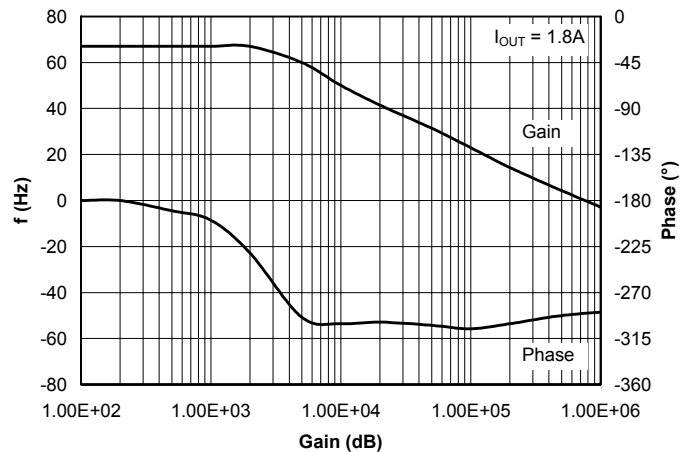

SC1548CSK-1.5 Small Signal Gain and Phase Shift vs. Frequency

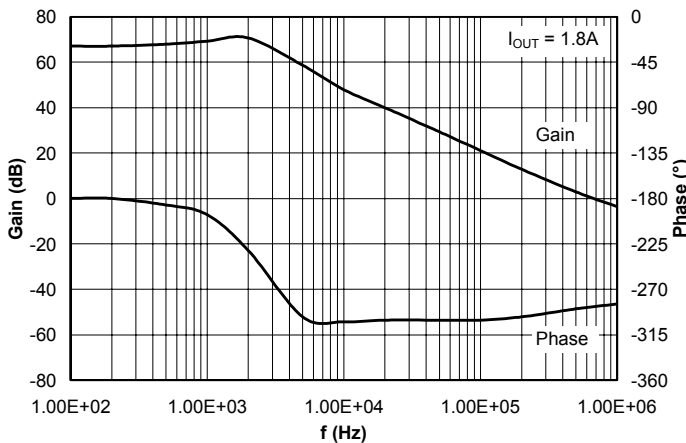

SC1548CSK Small Signal Gain and Phase Shift vs. Frequency

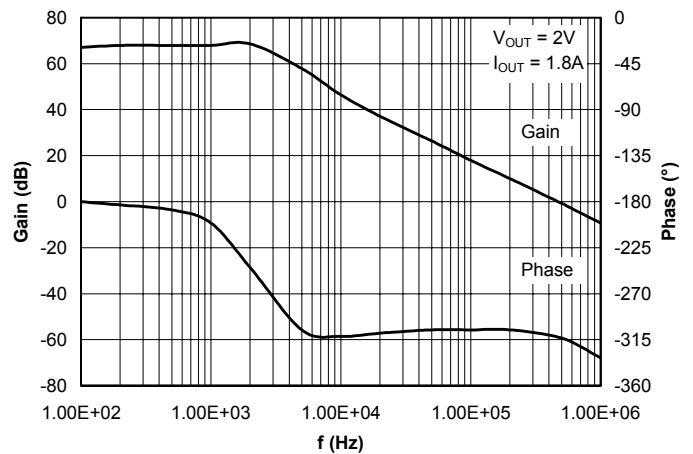

POWER MANAGEMENT

Typical Characteristics (Cont.)⁽¹⁾

Load Transient Response

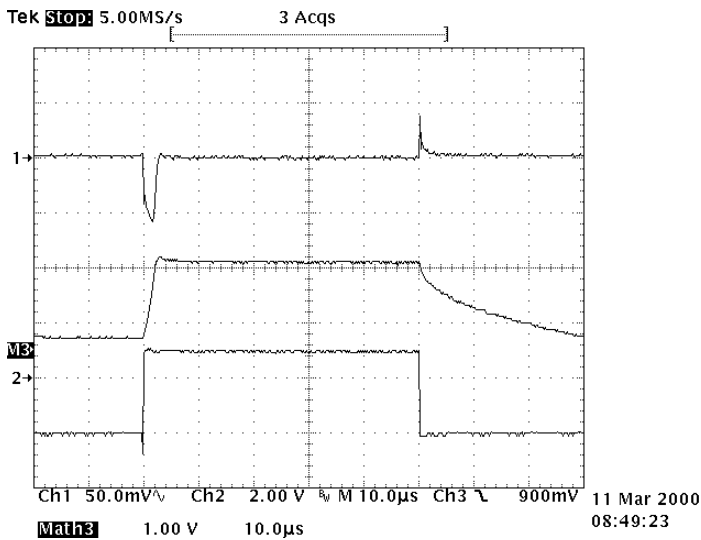

Trace 1: V_{OUT} , AC coupled, 50mV/div.
 Trace 2: V_{DRV} , 2V/div.
 Trace M3: load stepping from 0A to 1A to 0A
 Timebase: 10µs/div

Load Transient Response, Expanded

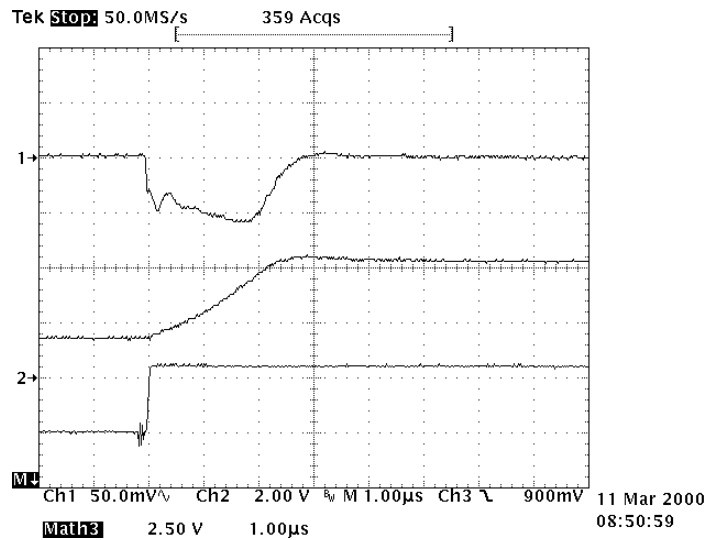

Trace 1: V_{OUT} , AC coupled, 50mV/div.
 Trace 2: V_{DRV} , 2V/div.
 Trace M3: load stepping from 0A to 1A
 Timebase: 1µs/div

Load Transient Response, Expanded

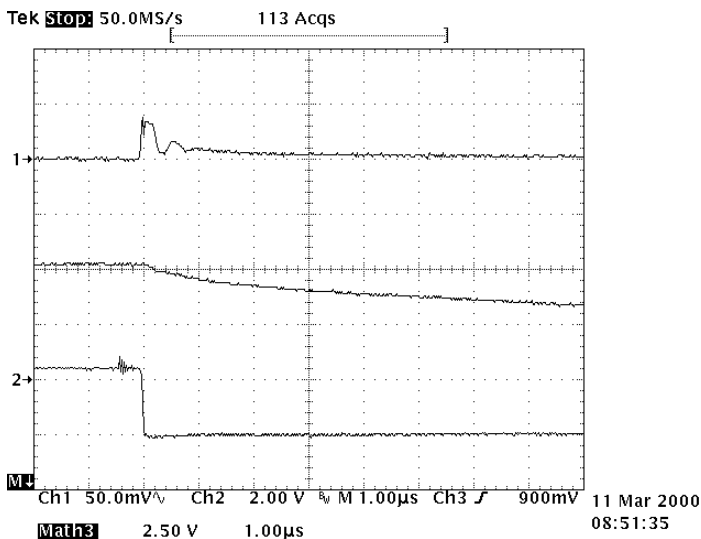

Trace 1: V_{OUT} , AC coupled, 50mV/div.
 Trace 2: V_{DRV} , 2V/div.
 Trace M3: load stepping from 1A to 0A
 Timebase: 1µs/div

Disable Delay Time, $t_{D(OFF)}$

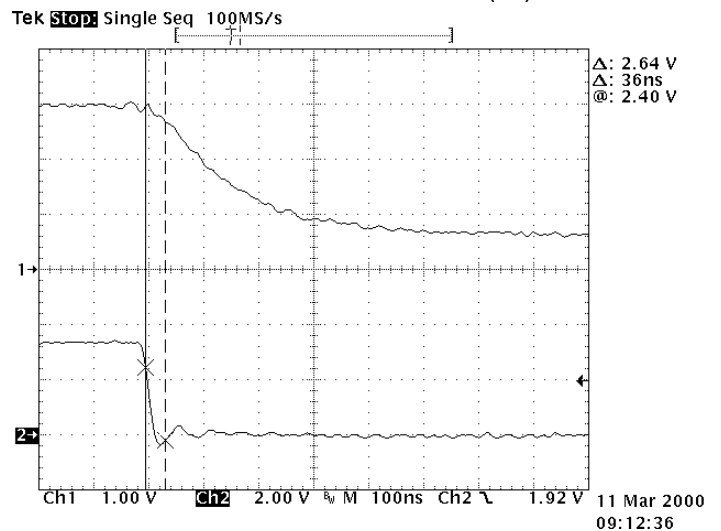

Trace 1: V_{DRV} , 1V/div.
 Trace 2: V_{EN} , 2V/div.
 Timebase: 100ns/div
 $t_{D(OFF)} \approx 36ns$

POWER MANAGEMENT

Typical Characteristics (Cont.)⁽¹⁾

Drive Output Fall Time, t_f

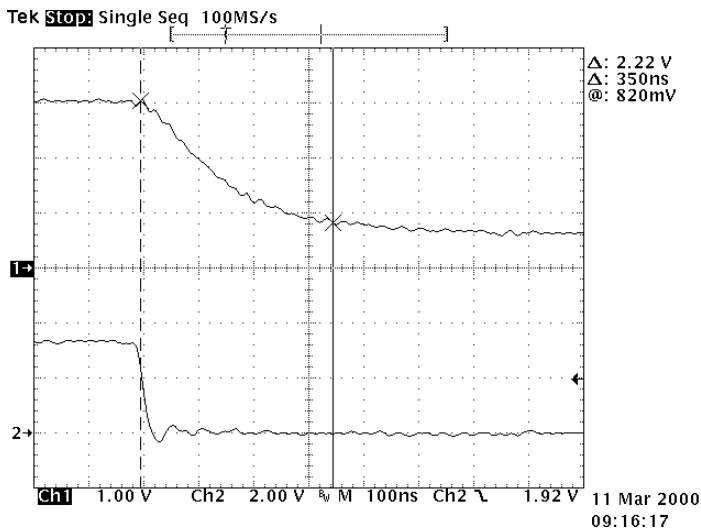

Trace 1: V_{DRV} , 1V/div.
 Trace 2: V_{EN} , 2V/div.
 Timebase: 100ns/div
 $t_f \approx 350$ ns

Enable Delay Time, $t_{D(ON)}$

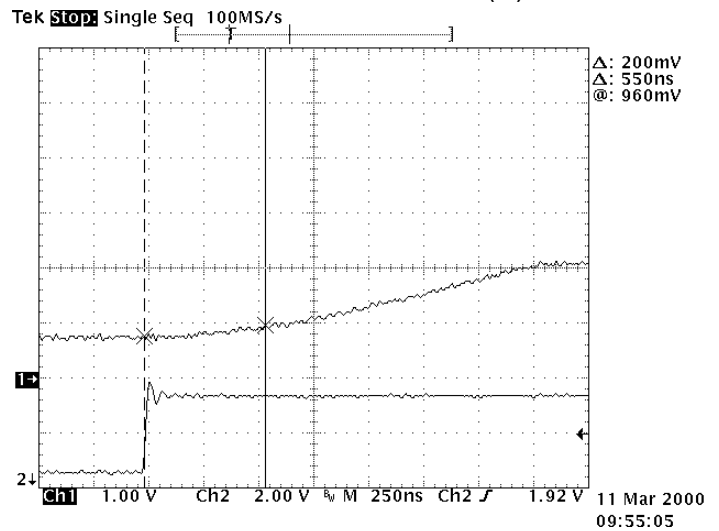

Trace 1: V_{DRV} , 1V/div.
 Trace 2: V_{EN} , 2V/div.
 Timebase: 250ns/div
 $t_{D(ON)} \approx 550$ ns

Drive Output Rise Time, t_r

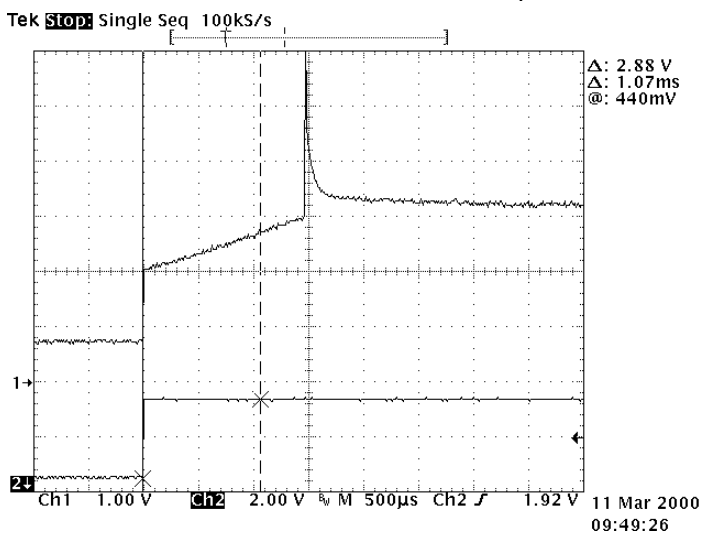

Trace 1: V_{DRV} , 1V/div.
 Trace 2: V_{EN} , 2V/div.
 Timebase: 500µs/div
 $t_r \approx 1$ ms

Power-up Output Short Circuit Immunity

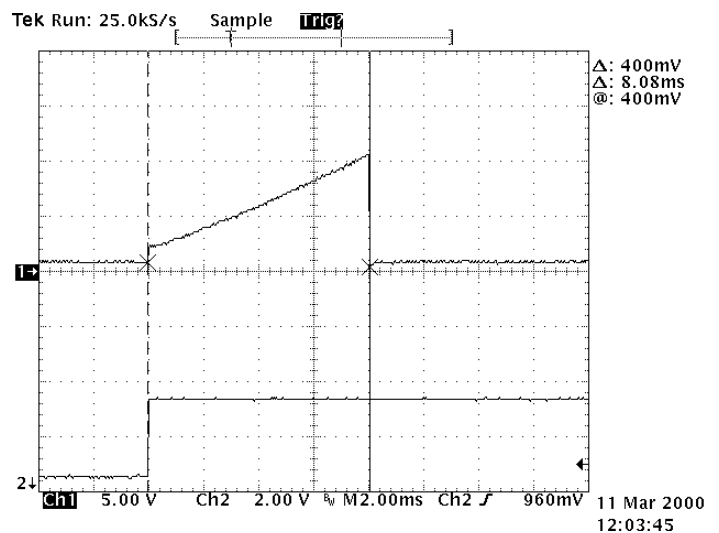

Trace 1: V_{DRV} , 5V/div.
 Trace 2: V_{EN} , 2V/div.
 Timebase: 2ms/div
 SC1548 enabled into a short, therefore $V_{OUT} < V_{TH(OC)}$
 immediately the device is enabled. This device shuts
 down after 8ms.

POWER MANAGEMENT

Typical Characteristics (Cont.)⁽¹⁾

Output Short Circuit Glitch Immunity

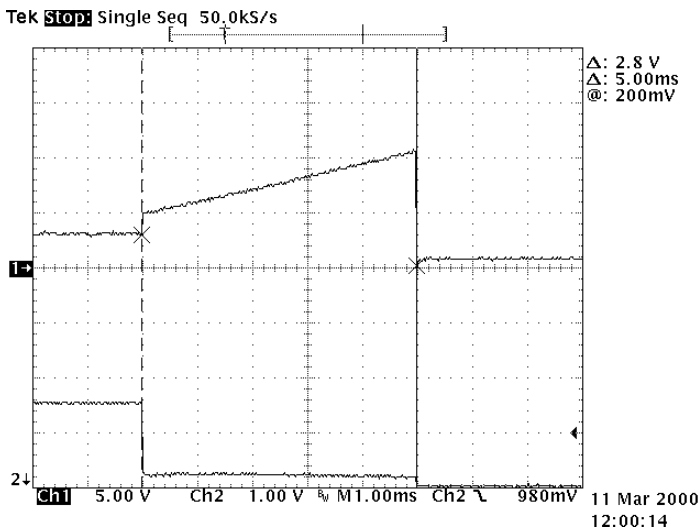

Trace 1: V_{DRV} , 5V/div.
 Trace 2: V_{OUT} , 1V/div.
 Timebase: 1ms/div
 SC1548 enabled, then shorted, therefore
 $V_{OUT} < V_{TH(OC)}$ immediately the short is applied. This
 device shuts down after 5ms.

Note:

(1) See Applications Circuit on page 1.

Applications Information

Theory Of Operation

The SC1548 linear FET controller provides a simple way to drive an N-channel MOSFET to produce a tightly regulated output voltage from an available, higher, supply voltage. It takes its power from a 12V supply, drawing typically 2mA while operating.

It contains an internal bandgap reference which is compared to the output voltage via a resistor divider. This resistor divider is internal on the fixed output voltage options, and user selectable on the adjustable option. Since the drive pin can pull up to a 9V guaranteed minimum, the device can be used to regulate a large range of output voltages by careful selection of the external MOSFET (see component selection, below).

The SC1548 includes an active high enable control with an internal pullup resistor. If this pin is pulled low, the drive pin is pulled low, turning off the N-channel MOSFET. If the pin is left open or pulled up to 2.5V, 3.3V or 5V, then the drive pin will be enabled.

Also included is an overcurrent protection circuit that monitors the output voltage. If the output voltage drops below 50% of nominal, as would occur during an overcurrent or short condition, the device will pull the drive pin low and latch off.

Fixed Output Voltage Options

Please refer to the Application Circuit on Page 1. The fixed output voltage parts have an internal resistor divider that draws a nominal 100µA from the output. The voltage at the common node of the resistor divider is then compared to the bandgap reference voltage of 1.263V. The drive pin voltage is then adjusted to maintain the output voltage set by the resistor divider. Referring to the block diagram on page 5, the nominal resistor values are:

Output Voltage	R1 (kΩ)	R2 (kΩ)
1.515V	2.52	12.63
1.818V	5.55	12.63

POWER MANAGEMENT

Applications Information (Cont.)

It is possible to adjust the output voltage of the fixed voltage options, by applying an external resistor divider to the sense pin (please refer to Figure 1 below). Since the sense pin sinks a nominal 100µA, the resistor values should be selected to allow 10mA to flow through the divider. This will ensure that variations in this current do not adversely affect output voltage regulation. Thus a target value for R2 (maximum) can be calculated:

$$R2 \leq \frac{V_{OUT(FIXED)}}{10mA} \quad \Omega$$

The output voltage can only be adjusted upwards from the fixed output voltage, and can be calculated using the following equation:

$$V_{OUT(ADJUSTED)} = V_{OUT(FIXED)} \cdot \left(1 + \frac{R1}{R2}\right) + R1 \cdot 100 \mu A \quad \text{Volts}$$

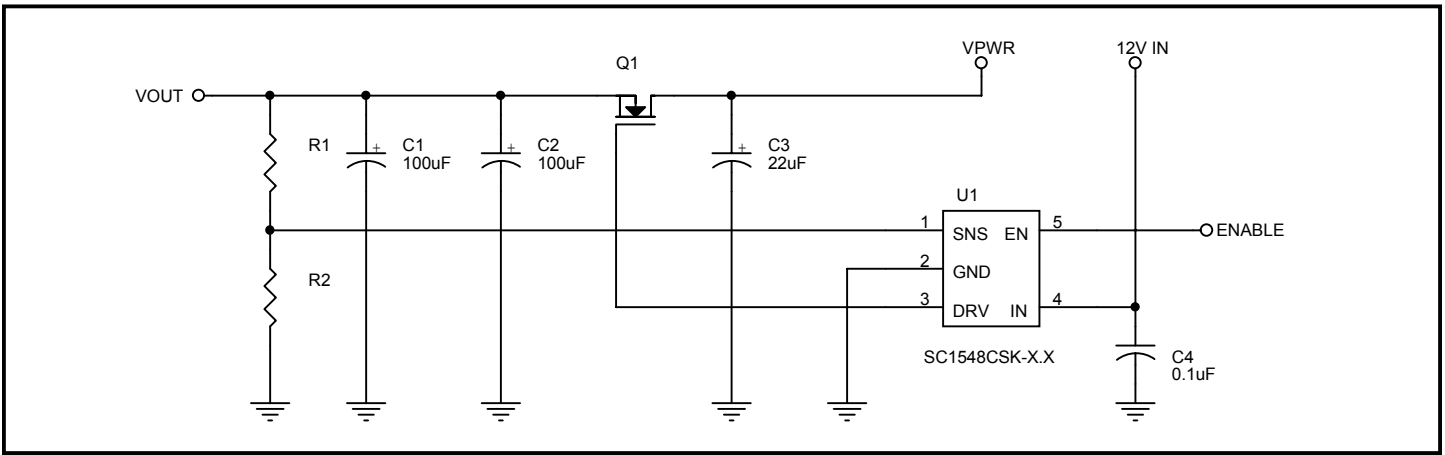

Figure 1: Adjusting The Output Voltage of Fixed Output Voltage Options

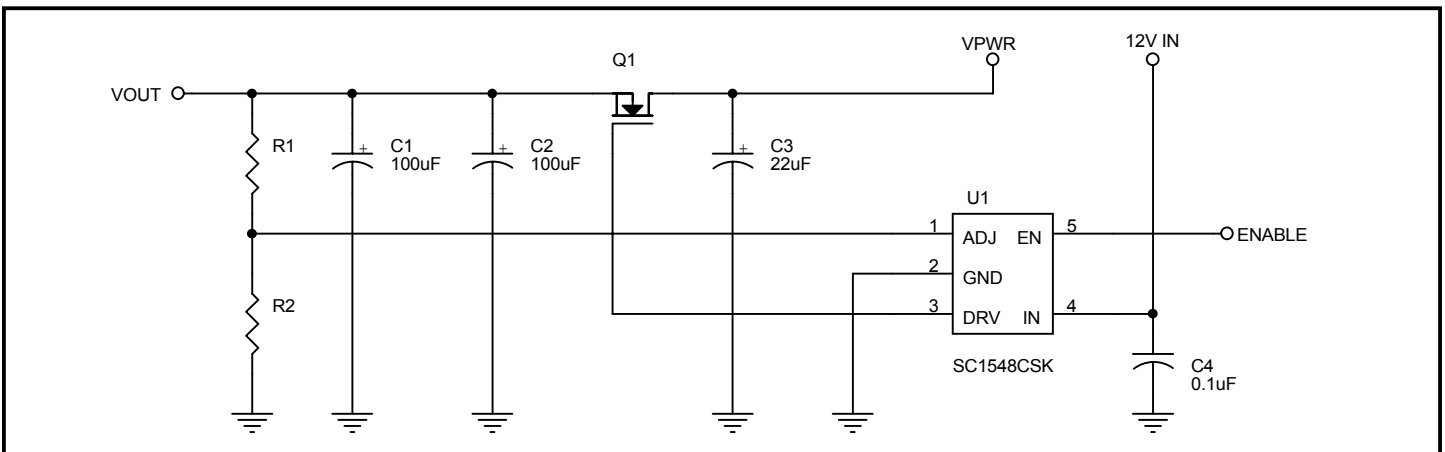

Figure 2: Setting The Output Voltage of the Adjustable Output Voltage Option

Adjustable Output Voltage Option

The adjustable output voltage option does not have an internal resistor divider. The adjust pin connects directly to the inverting input of the error amplifier, and the output voltage is set using external resistors (please refer to Figure 2 above). In this case, the adjust pin sources a nominal 0.5µA, so the resistor values should be selected to allow 50µA to flow through the divider.

Again, a target value for R2 (maximum) can be calculated:

$$R2 \leq \frac{1.263 V}{50 \mu A} \quad \Omega$$

The output voltage can be calculated as follows:

$$V_{OUT} = 1.263 \cdot \left(1 + \frac{R1}{R2}\right) - 0.5 \mu A \cdot R1$$

POWER MANAGEMENT
Applications Information (Cont.)

Please see Table 1 below for recommended resistor values for some standard output voltages. All resistors are 1%, 1/10W.

VOUT (V)	R1 (Ω)	R2 (Ω)
1.5	18.7	100
1.8	42.2	100
2.5	97.6	100
2.8	124	102
3.0	140	102
3.3	169	105

Table 1: Recommended Resistor Values For SC1548

The maximum output voltage that can be obtained from the adjustable option is determined by the input supply voltage and the $R_{DS(ON)}$ and gate threshold voltage of the external MOSFET. Assuming that the MOSFET gate threshold voltage is sufficiently low for the output voltage chosen and a worst-case drive voltage of 9V, $V_{OUT(MAX)}$ is given by:

$$V_{OUT(MAX)} = V_{PWR(MIN)} - I_{OUT(MAX)} \cdot R_{DS(ON)(MAX)}$$

Short Circuit Protection

The short circuit protection feature of the SC1548 is implemented by using the $R_{DS(ON)}$ of the MOSFET. As the output current increases, the regulation loop maintains the output voltage by turning the FET on more and more. Eventually, as the $R_{DS(ON)}$ limit is reached, the MOSFET will be unable to turn on any further, and the output voltage will start to fall. When the output voltage falls to approximately 50% of nominal, the LDO controller is latched off, setting output voltage to 0V. Toggling the enable pin or cycling the power will reset the latch.

To prevent false latching due to capacitor inrush currents or low supply rails, the current limit latch is initially disabled. It is enabled at a preset time (nominally 5ms) after both IN and EN rise above their lockout points. If EN is left floating (using the internal resistor pullup), then V_{PWR} should come up before V_{IN} , or the device will latch off. If the enable function is not being used, EN should be tied to V_{PWR} .

To be most effective, the MOSFET $R_{DS(ON)}$ should not be selected artificially low. The MOSFET should be chosen so that at maximum required current, it is almost fully turned on. If, for example, a supply of 1.5V at 4A is required from a $3.3V \pm 5\%$ rail, the maximum allowable $R_{DS(ON)}$ would be:

$$R_{DS(ON)(MAX)} = \frac{(0.95 \cdot 3.3 - 1.5 \cdot 1.025)}{4} \approx 400 \text{ m}\Omega$$

To allow for temperature effects 200mΩ would be a suitable room temperature maximum, allowing a peak short circuit current of approximately 15A for a short time before shutdown.

Capacitor Selection

Output Capacitors: low ESR aluminum electrolytic or tantalum capacitors are recommended for bulk capacitance, with ceramic bypass capacitors for decoupling high frequency transients.

Input Capacitors: placement of low ESR aluminum electrolytic or tantalum capacitors at the input to the MOSFET (V_{PWR}) will help to hold up the power supply during fast load changes, thus improving overall transient response. The 12V supply should be bypassed with a 0.1μF ceramic capacitor.

Layout Guidelines

One of the advantages of using the SC1548 to drive an external MOSFET is that the bandgap reference and control circuitry do not need to be located right next to the power device, thus a very accurate output voltage can be obtained since heating effects will be minimal.

The 0.1μF bypass capacitor should be located close to the supply pin, and connected directly to the ground plane. The ground pin of the device should also be connected directly to the ground plane. The sense or adjust pin does not need to be close to the output voltage plane, but should be routed to avoid noisy traces if at all possible.

Power dissipation within the device is practically negligible, requiring no special consideration during layout.

POWER MANAGEMENT

Outline Drawing - SOT-23-5

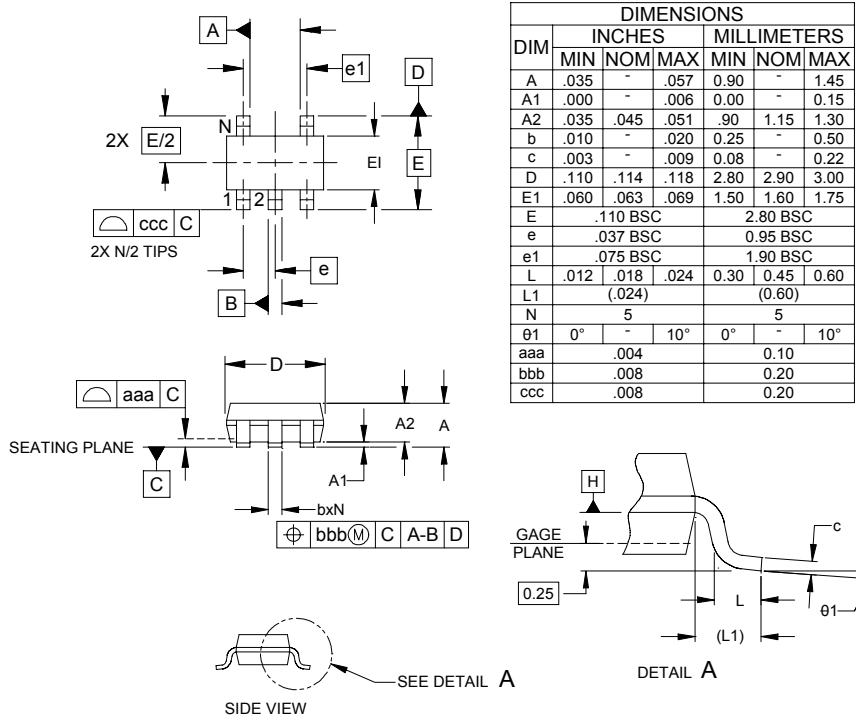

- NOTES:
1. CONTROLLING DIMENSIONS ARE IN MILLIMETERS (ANGLES IN DEGREES).
 2. DATUMS **-A-** AND **-B-** TO BE DETERMINED AT DATUM PLANE **-H-**
 3. DIMENSIONS "E1" AND "D" DO NOT INCLUDE MOLD FLASH, PROTRUSIONS OR GATE BURRS.

Land Pattern - SOT-23-5

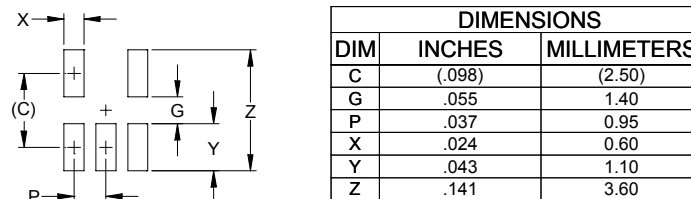

- NOTES:
1. THIS LAND PATTERN IS FOR REFERENCE PURPOSES ONLY. CONSULT YOUR MANUFACTURING GROUP TO ENSURE YOUR COMPANY'S MANUFACTURING GUIDELINES ARE MET.

Contact Information

Semtech Corporation
 Power Management Products Division
 200 Flynn Road, Camarillo, CA 93012
 Phone: (805)498-2111 FAX (805)498-3804