

SPDL485025 Series

Ultra Compact SMD Common Mode Chokes

The SPDL485025 product series is an expansion of Signal's SPDL Series of compact SMD common mode chokes for suppression of common mode noise as required in electronic devices filtering power line signals. It is applicable to high density devices in the consumer, industrial and interface markets.

In many of today's electronic designs, smaller size and weight reduction is always of interest. This is evident in many applications such as computers, peripherals and personal charging devices which employ surface mount technology. Performance is still essential with higher current capability.

In conjunction with the latest winding technology and ferrite cores, Signal's SPDL Series II designs achieve the most effective noise suppression, offering high common mode impedance in the noise band with the highest possible current ratings in most models.



General Features

- Compact SMD topology
- Ferrite toroid core construction
- Magnetically shielded
- Excellent common mode EMI noise suppression
- Virtually no distortion of high-speed signals
- Excellent thermal characteristics over temperature

Specifications

- Number of Lines: Two
- Impedance range: 100 to 1400 ohms at 100 MHz
- Current Rating Range: 1.5 A to 16.5 A
- Operating Temperature Range: -40 °C to +125 °C
- Storage Temperature Range: -40 °C to +85 °C

Applications

- Electromagnetic interference (EMI)
- Demanding adapter lines & battery lines
- Larger electronic equipment
- Personal Computers, Peripherals, IoT

PRODUCT IDENTIFICATION

SP DL 485025 - 500 - 2P - T
 (1) (2) (3) (4) (5) (6)

- (1) Type: Surface Mount Devices
- (2) Style: Wire Wound Type Common Mode Filter
- (3) Dimensions in mm:

CODE	WIDTH	LENGTH	HEIGHT
485025	4.8	5.0	2.5

- (4) Impedance: 500 for 500 Ω (Impedance tolerance: $\pm 30\%$)
- (5) 2P: 2 Lines
- (6) Temperature product code: T = temp. -40 ~ 125 $^{\circ}\text{C}$

MECHANICAL SPECIFICATIONS

Dimensions are in mm.

SERIES	A ± 0.3	B ± 0.3	C Max	D ± 0.4	E ± 0.4	F ± 0.4	G ± 0.4	H Ref	I Ref	J Ref	K Ref
SPDL485025	4.8	5.0	2.5	1.25	1.7	1.6	1.0	1.8	2.4	1.2	0.8

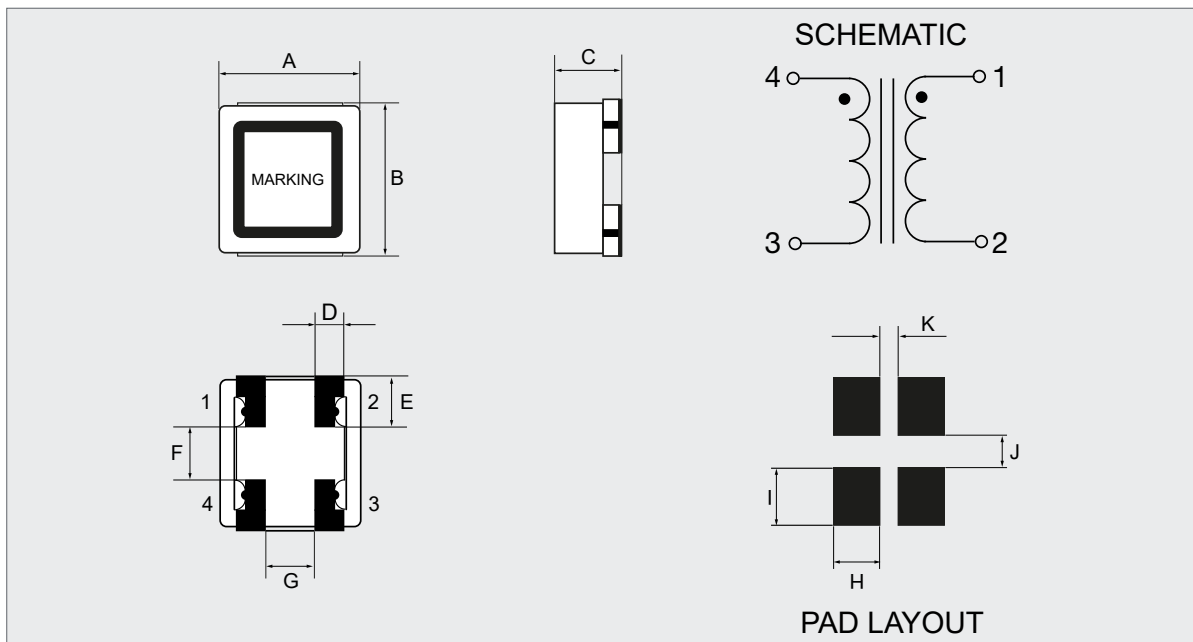

- Coplanarity: 0.15 Max

Custom versions available upon request.



128 Atlantic Avenue, Lynbrook, NY 11563
 Toll Free 866-239-5777 | Tel 516-239-5777 | Fax 516-239-7208
 sales@signaltransformer.com | techhelp@signaltransformer.com

belfuse.com/signal

ELECTRICAL SPECIFICATIONS

Electrical specifications for all part numbers measured at 25°C unless otherwise stated.

SPDL485025 SERIES

Part Number	Impedance @ 100 MHz (Ω)	DCR ± 40% (mΩ)	Rated Voltage (V) Max.	Insulation Resistance (MΩ) Min.	Rated Current (A) Max.	Withstand Voltage (V)
SPDL485025-100-2P-T	100	9	50	10	6.5	125
SPDL485025-250-2P-T	250	14	50	10	5.0	125
SPDL485025-350-2P-T	350	28	50	10	4.0	125
SPDL485025-500-2P-T	500	19	50	10	4.0	125
SPDL485025-1000-2P-T	1000	24	50	10	2.0	125
SPDL485025-1400-2P-T	1400	40	50	10	1.5	125

- Test Frequency: 100 MHz
- Impedance tolerance: ±30%

TYPICAL PERFORMANCE CURVES

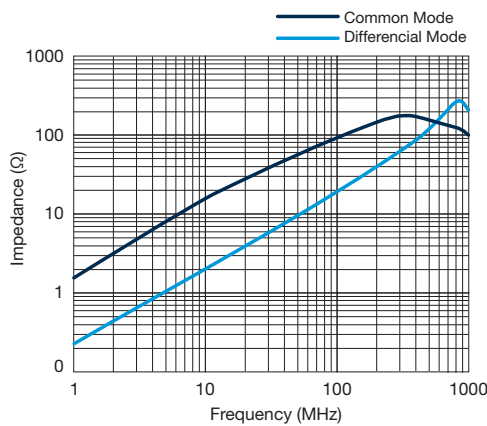

SPDL485025-100-2P-T

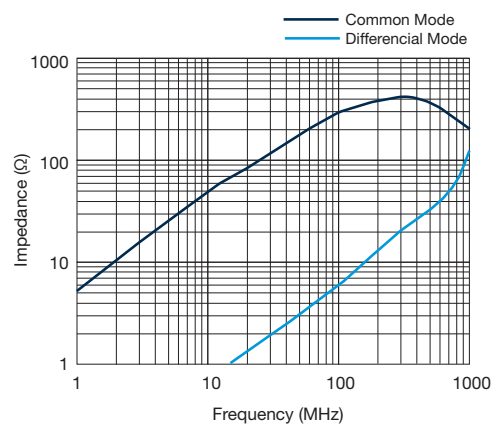

SPDL485025-250-2P-T

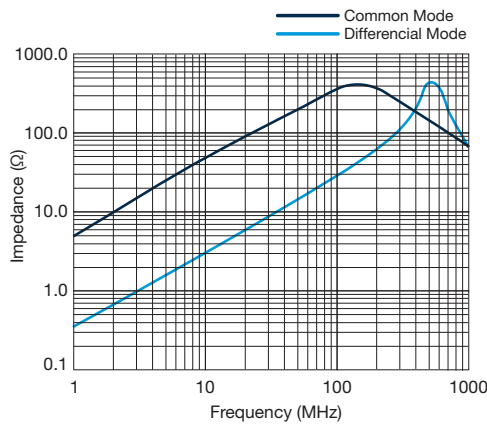

SPDL485025-350-2P-T

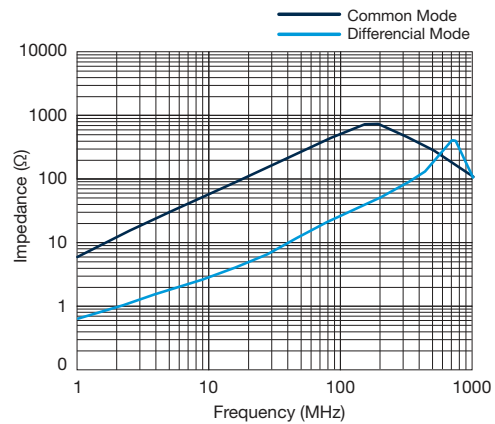

SPDL485025-500-2P-T

Custom versions available upon request.



128 Atlantic Avenue, Lynbrook, NY 11563
 Toll Free 866-239-5777 | Tel 516-239-5777 | Fax 516-239-7208
 sales@signaltransformer.com | techhelp@signaltransformer.com

belfuse.com/signal

SPDL485025 Series

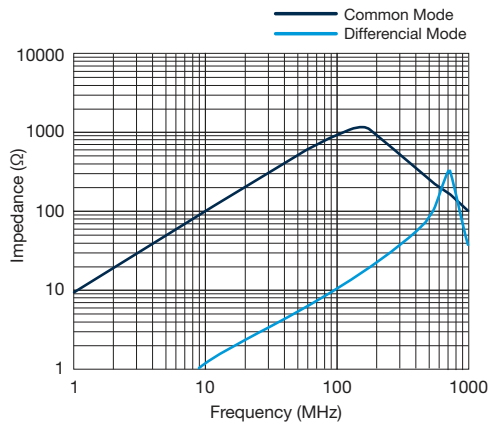

SSPDL485025-1000-2P-T

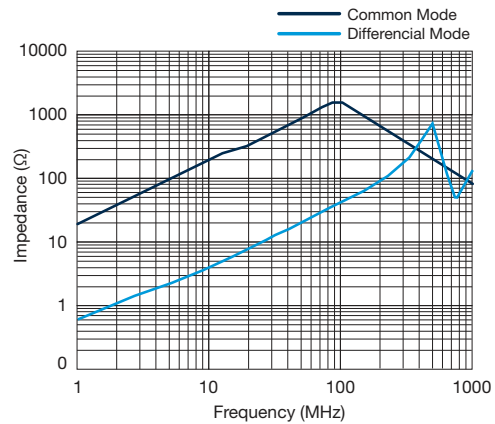

SPDL485025-1400-2P-T

- Test equipment**

Z: measured on Agilent 4991A RF Impedance or equivalent

DCR: measured on Chroma 16502 micro micro-OHM meter or equivalent

Rated current: measured on Agilent 4284A LCR meter with 42841A Current Source or equivalent

- Notice**

There could be measurement deviations with different instruments due to different test principles / internal resistance. Open and Short compensation is performed before testing.

RECOMMENDED REFLOW SOLDERING CONDITIONS (SMT-TYP)

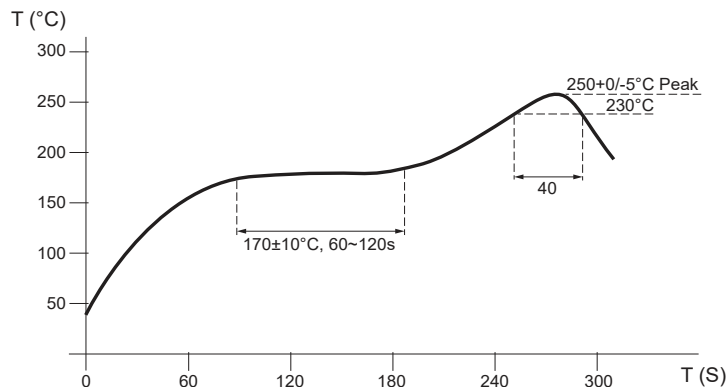

ADD:

The recommended reflow conditions as above graph, is set according to our soldering equipment, due to various manufactures may have different reflow soldering equipment, products, process conditions, set methods, and so on. When setting the reflow conditions, please adjust and confirm according to users' environment/equipment.

Notice:

- Solder reflow temperature: +250°C Max. for 10 seconds max.
- To solder inductors by soldering iron is not recommended.
- Please contact us for details

Custom versions available upon request.



128 Atlantic Avenue, Lynbrook, NY 11563
 Toll Free 866-239-5777 | Tel 516-239-5777 | Fax 516-239-7208
 sales@signaltransformer.com | techhelp@signaltransformer.com

belfuse.com/signal

TAPE AND REEL SPECIFICATIONS

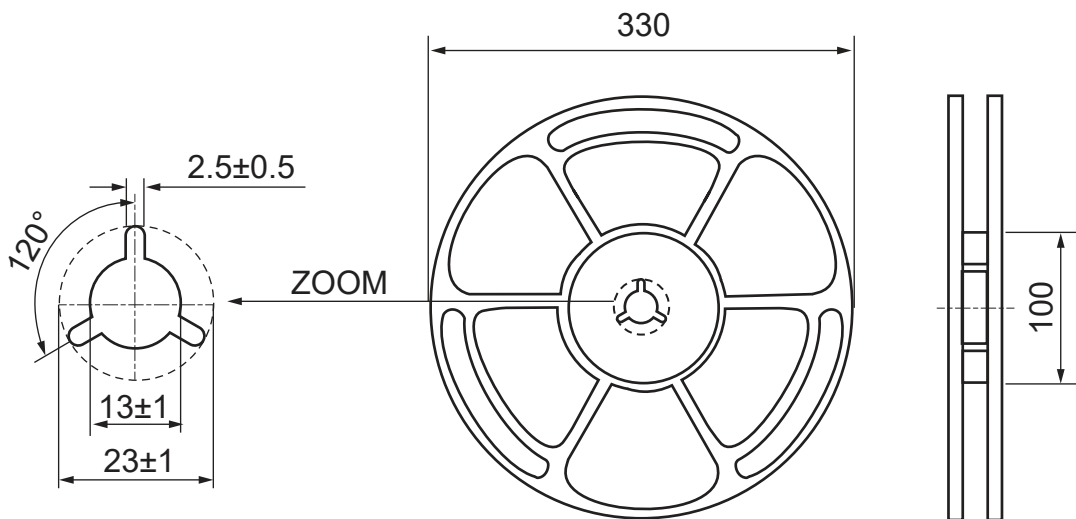
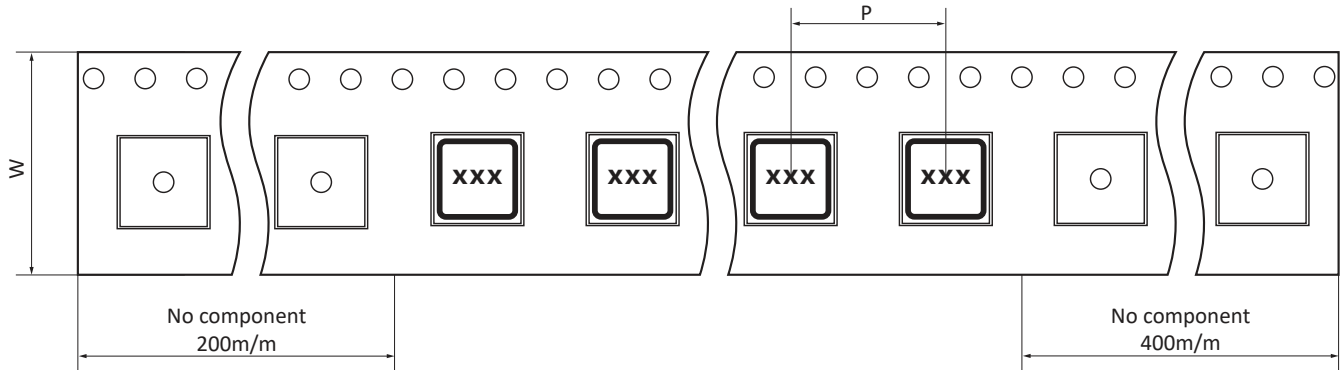

Part Number	Reel Spec.	W	P	Pcs / Reel
SPDL485025	13"	12	8	2500

Taping Specification: EIA -481 Compliant

Custom versions available upon request.



128 Atlantic Avenue, Lynbrook, NY 11563
 Toll Free 866-239-5777 | Tel 516-239-5777 | Fax 516-239-7208
 sales@signaltransformer.com | techhelp@signaltransformer.com

belfuse.com/signal



About Signal Transformer

Signal Transformer is known as the world's leader of wire wound magnetic solutions since 1959. With over 50 years of experience manufacturing transformers, chokes, inductors and custom or modified standard products. Signal offers not only the most comprehensive line of certified standard power conversion products, with our vast engineering, manufacturing and regulatory resources; Signal Transformer excels in the design and manufacturer of cost effective, specialized platforms.



**For more information,
please contact us:**

128 Atlantic Avenue
Lynbrook, NY 11563

Toll Free +1 866-239-5777

Tel +1 516-239-5777

Fax +1 516-239-7208

sales@signaltransformer.com
techhelp@signaltransformer.com

[belfuse.com/signal](https://www.belfuse.com/signal)

