

ELECTRICAL SPECIFICATIONS

PARAMETER	VALUE	TEST CONDITION
D.C. FIRING VOLTAGE:	200V±20% D.C.	(dv/dt 100V/5)
IMPULSE CURRENT:	1KA MAX.	(8/20μS)
A.C. DISCHARGE CURRENT:	1A	(50Hz, 9 CYCLES)
INSULATION RESISTANCE:	10 <sup>4</sup> MΩ MIN.	50 VDC
INTER-ELECTRODE CAPACITANCE:	1.0 PF MAX.	1.0kHz

ENVIRONMENTAL SPECIFICATIONS PER MIL-STD 202

TEST	METHODE	CONDITION	RATING
VIBRATION TESTING:	204B	C	10-55HZ, 0.6DA
SHOCK	213A	C	100G
HUMIDITY:	103B	B	95%RE.HUMIDITY
TEMPERATURE CYCLING:	102A	C	-65 TO +125 °C
BAROMETRIC PRESSURE:	105C	B	50,000FT.
THERMAL SHOCK:	107	B	-65 TO +125 °C
SOLDERABILITY:	20B	B	

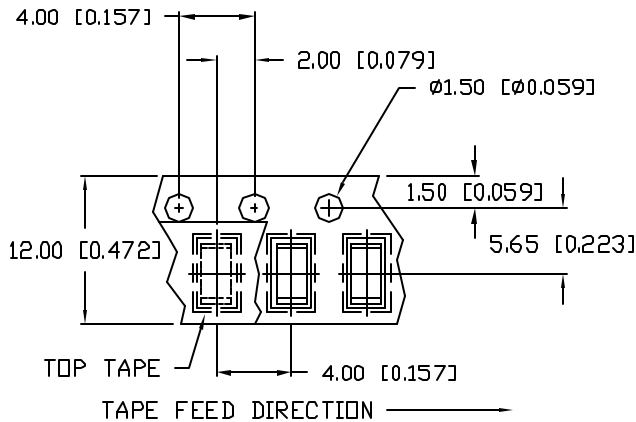

RECOMMENDED SOLDER PAD LAYOUT

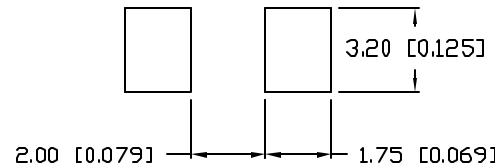

NOTES:

1. 500 PIECES PER REEL.

\*UNLESS OTHERWISE SPECIFIED TOLERANCES PER DECIMAL PRECISION ARE: X=±1 (±0.038), XX=±0.5 (±0.020), XXX=±0.25 (±0.010), XXXX=±0.127 (±0.005). LEAD SIZE=±0.05 (±0.002), LEAD LENGTH=±0.75 (±0.030). MIN= +DECIMAL PRECISION -0.00, MAX= +0.00 -DECIMAL PRECISION

REV. PART NUMBER  
GT-SMD181220012-TR

3.2 x 4.5mm SURFACE MOUNT SURGE,  
ARRESTOR, 200V.

**CONFIDENTIAL INFORMATION**  
THE INFORMATION CONTAINED IN THIS DOCUMENT IS THE PROPERTY OF LUMEX INC. EXCEPT AS SPECIFICALLY AUTHORIZED IN WRITING BY LUMEX INC., THE HOLDER OF THIS DOCUMENT SHALL KEEP ALL INFORMATION CONTAINED HEREIN CONFIDENTIAL AND SHALL PROTECT SAME IN WHOLE OR IN PART FROM DISCLOSURE AND DISSEMINATION TO ALL THIRD PARTIES.

**RELIABILITY NOTE**  
OUR MANY YEARS OF EXPERIENCE DATA ACCUMULATION INDICATE THAT SOLDER HEAT IS A MAJOR CAUSE OF EARLY AND FUTURE FAILURE. PLEASE PAY ATTENTION TO YOUR SOLDERING PROCESS.



290 E. HELEN ROAD  
PALATINE, IL 60067-6976  
PHONE: +1.847.359.2790  
US WEB: www.lumex.com  
TW WEB: www.lumex.com.tw

DRAWN BY: CHECKED BY: APPROVED BY: DATE: 11.08.04  
PAGE: 1 OF 1  
SCALE: N/A