

Using the Evaluation Board

The ISL6402 and ISL6402A are high performance triple-output controllers offering control and protection features for 2 synchronous buck PWMs and 1 linear regulator.

The ISL6402, ISL6402A evaluation boards highlight the operation of the IC in embedded DC-DC converter applications. Table 1 shows the available evaluation boards.

TABLE 1. EVALUATION BOARDS

BOARD NAME	IC	PACKAGE
ISL6402EVAL4	ISL6402IR	28 Ld QFN
ISL6402AEVAL4	ISL6402AIR	28 Ld QFN

Recommended Test Equipment

- A 4.5V-24V, 5A capable power supply
- An electronic load
- Four channel oscilloscope with probes
- Precision digital multimeters

Power and Load Connections

Input Voltage - The input power supply can be connected in two different ways depending on the input voltage supplied to the PWM power stage. When connecting to a 5.6V-20V power supply, connect the positive lead of the power supply to VIN (P1) post and the ground lead of the supply to the GND (P2) post.

When connecting to a 4.5V-5.5V input, the Vin (P1) and VCC_5V (P10) posts must be shorted using the jumper (JP1) before connecting the positive lead of the supply to the Vin (P1) post and the ground lead to the GND (P2) post.

The input voltage to the linear regulator can be supplied from a 3.3V/5V power supply by connecting the positive lead of the power supply to the VIN3 (P13) post and the ground terminal to the GND (P14) post.

Output Adjustment

Change the respective output voltage feedback resistors to modify the output voltage:

$$V_{OUT1} = 0.8 \cdot \left(1 + \frac{R_7}{R_8} \right) \quad V_{OUT2} = 0.8 \cdot \left(1 + \frac{R_9}{R_{10}} \right)$$

$$V_{OUT3} = 0.8 \cdot \left(1 + \frac{R_{15}}{R_{16}} \right)$$

Soft Start and Shutdown

The soft start capacitors can be adjusted for sequencing of the output voltages, PWM startup tracking, and/or to adjust the startup current required to charge the output capacitors.

$$t_{SS(PWM1)} = C_6 \cdot \frac{0.8V}{5\mu A} \quad t_{SS(PWM2)} = C_5 \cdot \frac{0.8V}{5\mu A}$$

To independently shutdown the PWMs, the SD1 or SD2 pin can be pulled to GND using the on board jumpers, JP2 and JP3 respectively.

SYNC Function

The ISL6402, ISL6402A can synchronize to another ISL6402, ISL6402A. The SYNC pin sends out pulses at 4 times the switching frequency for the ISL6402A and 16 times the switching frequency of the ISL6402. The SYNC function is bidirectional so if two or more ICs are SYNC, only 1 will be the master. All other ICs will SYNC to the master. The SYNC feature can be evaluated on the eval board. The SYNC pin is pulled to VCC_5V through R17. This resistor should be removed and a 1K resistor should be placed at R19. With the 1K resistor from SYNC to ground, the SYNC pulses can be observed on a scope.

Power Good

When both PWMs are within $\pm 10\%$ of their set value and the linear regulator output is within 75% of its set value, the PGOOD signal will go high. The open drain PGOOD pin is pulled HIGH to VCC_5V on the board. The PGOOD circuitry monitors the FBx pin of each regulated output to determine if the outputs are in regulation. If the linear controller is not used, the VOUT3 post P15 can be tied to VCC_5V so that the PGOOD function can be evaluated without the linear output. PGOOD can be monitored at post P8.

Overcurrent Protection

The overcurrent thresholds can be adjusted on the ISL6402, ISL6402A evaluation board. The current sense resistors, ISENSE, are set at 1.4K. The overcurrent set resistor is 120K. The overcurrent trip point can be adjusted by modifying ROCSET, R11 and R12:

$$R_{OCSET} = \frac{7 \cdot R_{CS}}{I_{OC} \cdot R_{DS(on)}}$$

ROCSET is the overcurrent set resistor, RCS is the current sense resistor, IOC is the desired overcurrent trip point, and rDS(ON) is the on resistance of the respective PWM's lower MOSFET. Refer to the ISL6402, ISL6402A datasheets for more information on how to select the current sense and overcurrent select resistors.

ISL6402AEVAL4 Schematic

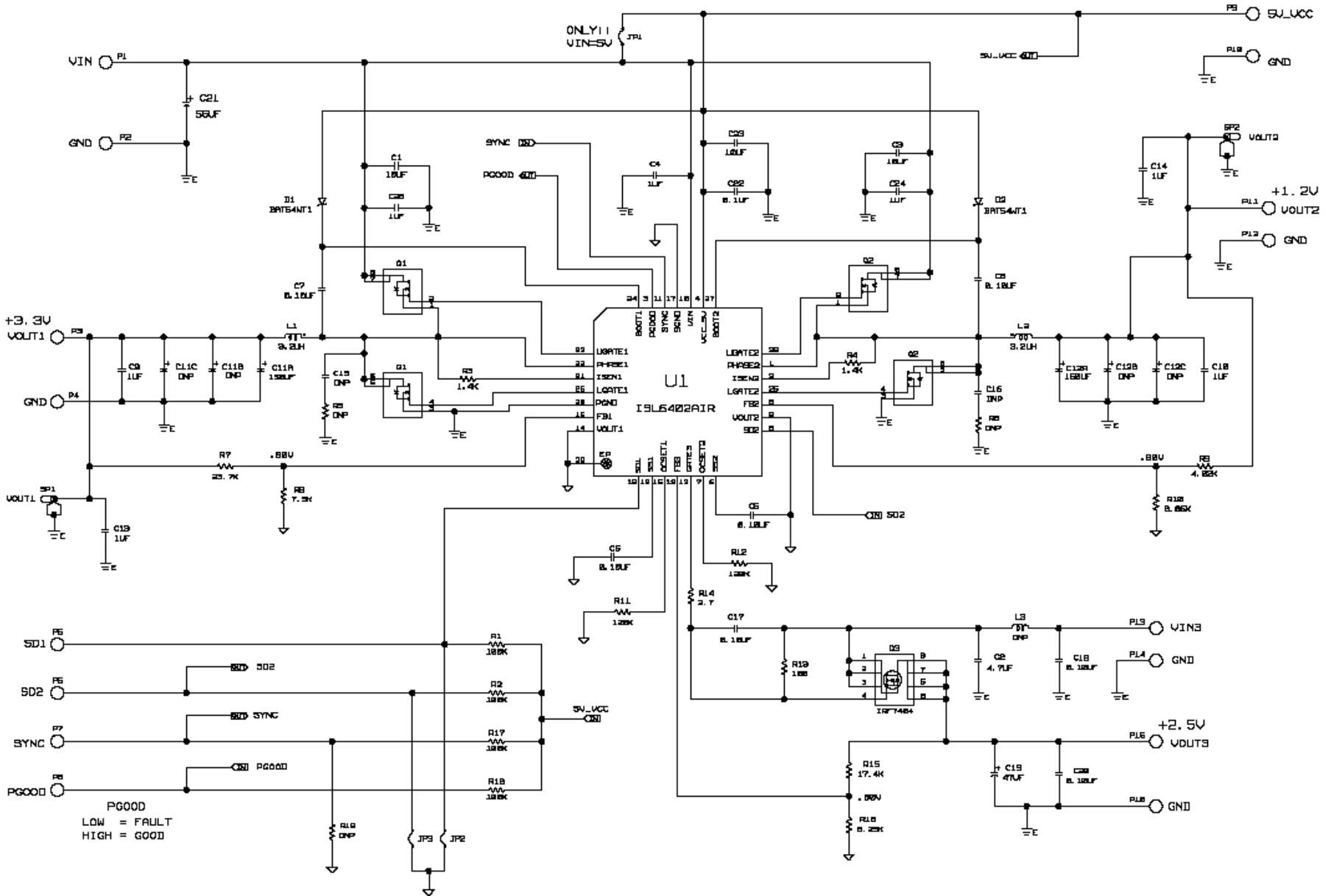

Application Note 1130

ISL6402AEVAL4 Bill of Materials

ITEM	REFERENCE	QTY	PART NUMBER	PART TYPE	DESCRIPTION	PKG.	VENDOR
1	U1	1	ISL6402AIR	IC, Linear	Dual PWM Controller, 1.4MHz	28 QFN	Intersil
2	D1, D2	2	BAT54WT1	Diode, Schottky	30V, 200mA	SOT-323	On Semi
3	Q1, Q2	2	FDS6990S	MOSFET, Dual	N-Chan, 30V, 7.5A, 0.022Ω	SOIC-8	Fairchild
4	Q3	1	IRF7404	MOSFET, Power, HEXFET	P-Chan, 20V, 6.7A, 0.04Ω	SOIC-8	IR
5	L1, L2	2	ETQP6F3R2HFA	Power Choke Coil	3.2μH, 25%, 8.6A	PCC-N6	PANASONIC
6	L3	1	BLM21PG300SN1	Ferrite Bead		SM_0805	Murata
7	C1, C3	2	TMK325BJ106KM	Capacitor, Ceramic, X5R	10μF, 10%, 25V	SM_1210	Taiyo Yuden/Generic
8	C2	1	12103D475KAT2A	Capacitor, Ceramic, XR5	4.7μF, 10%, 25V	SM_1210	AVX/Generic
9	C4, C24, C28	3	12063C105KAT2A	Capacitor, Ceramic, X7R	1.0μF, 10%, 25V	SM_1206	AVX/Generic
10	C9, C10, C13, C14	4	0805ZC105KAT2A	Capacitor, Ceramic, X7R	1.0μF, 10%, 10V	SM_0805	AVX/Generic
11	C11A, C12A	2	10TPB150ML	Capacitor, Tantalum	150μF, 20%, 10V	CASE-D3L	SANYO
12	C11B, C11C, C12B, C12C (DNP)	4		Capacitor, Tantalum		CASE-D3L	SANYO
13	C15, C16 (DNP)	2		Capacitor, Ceramic		SM_0805	AVX/Generic
14	C5, C6, C7, C8, C17, C18, C20	7	08053C104KAT2A	Capacitor, Ceramic, X7R	0.1μF, 10%, 25V	SM_0805	AVX/Generic
15	C19	1	16TPB47M	Capacitor, Tantalum	47μF, 20%, 16V	CASE-D3	SANYO
16	C21	1	25SP56M	Capacitor, Aluminum	56μF, 20%, 25V	Radial	SANYO
17	C22	1	0603YC104KAT2A	Capacitor, Ceramic, X7R	0.1μF, 10%, 16V	SM_0603	AVX/Generic
18	C23	1	1210ZC106MAT2A	Capacitor, Ceramic, X7R	10μF, 20%, 10V	SM_1210	AVX/Generic
19	R1, R2, R17, R18	4		Resistor, Film	100kΩ, 1%, .1W	SM_0603	Panasonic
20	R3, R4	2		Resistor, Film	1.4kΩ, 1%, .1W	SM_0603	Panasonic
21	R5, R6 (DNP)	0		Resistor, Film	TBD	SM_0805	Panasonic
22	R7	1		Resistor, Film	23.7kΩ, 1%, 1/16W	SM_0603	Panasonic
23	R8	1		Resistor, Film	7.50kΩ, 1%, 1/16W	SM_0603	Panasonic
24	R9	1		Resistor, Film	4.02kΩ, 1%, 1/16W	SM_0603	Panasonic
25	R10	1		Resistor, Film	8.06kΩ, 1%, 1/16W	SM_0603	Panasonic
26	R11, R12	2		Resistor, Film	120kΩ, 1%, 1/16W	SM_0603	Panasonic
27	R13	1		Resistor, Film	100Ω, 1%, .1W	SM_0805	Panasonic
28	R14	1		Resistor, Film	2.7Ω, 5%, 1/16W	SM_0603	Panasonic
29	R15	1		Resistor, Film	17.4kΩ, 1%, 1/16W	SM_0603	Panasonic
30	R16	1		Resistor, Film	8.25kΩ, 1%, 1/16W	SM_0603	Panasonic
31	R19 (DNP)	1		Resistor, Film		SM_0603	Panasonic
	Misc.						
32	P1 - P16	16	1514-2	Turret Post	Terminal post, through hole, 1/4 inch tall	PTH	
33	JP1, JP2, JP3	3	68000-236-1X2	Header	1X2 Break Strip GOLD	1X2@.1"	
34	JP1 (DNP)	0	S9001-ND	Jumper	2 pin jumper		Digikey
35	JP2 - JP3	2	S9001-ND	Jumper	2 pin jumper		Digikey
36	SP1, SP2	2	129-0701-202	Terminal, Scope Probe	Terminal, Scope Probe		Johnson

ISL6402AEVAL4 Layout

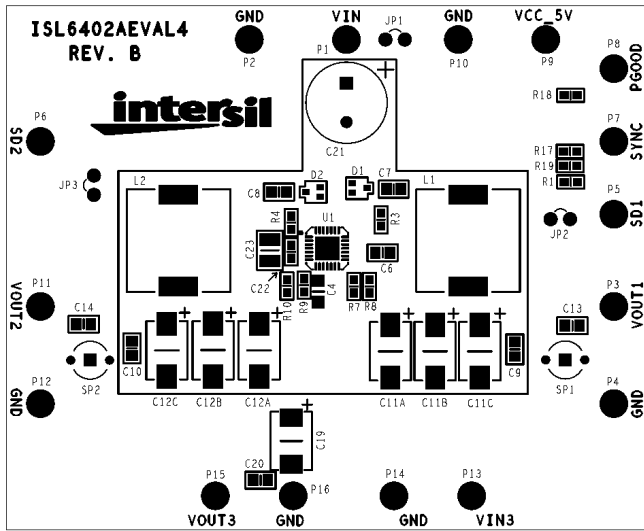

TOP SILK

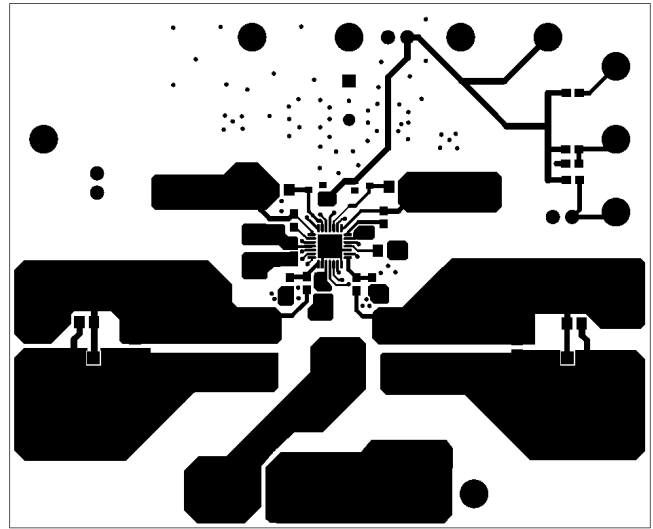

LAYER 1

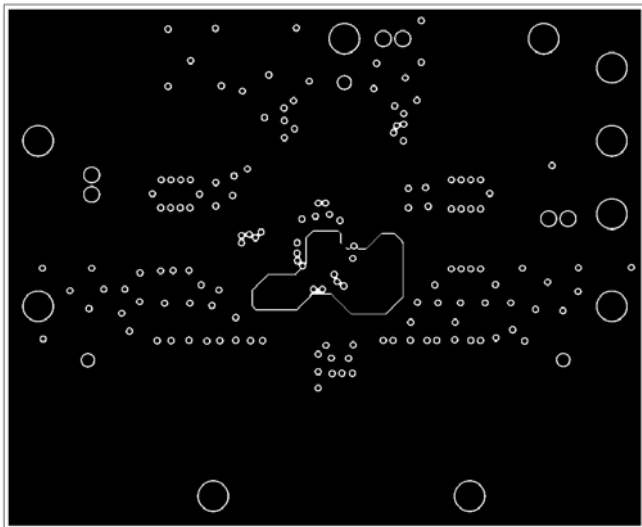

LAYER 2

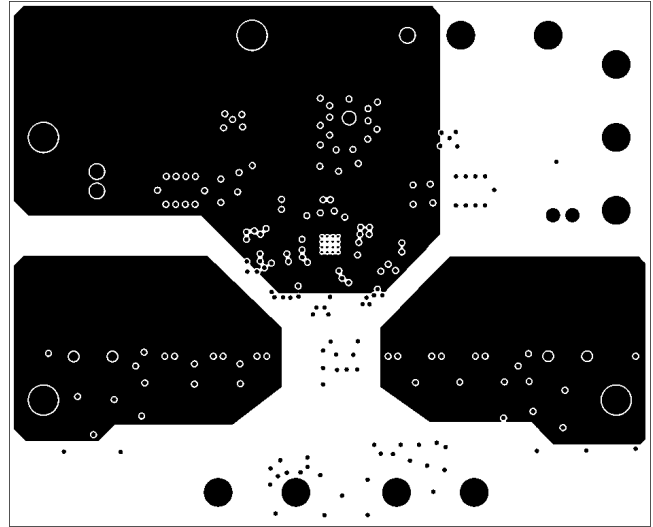

LAYER 3

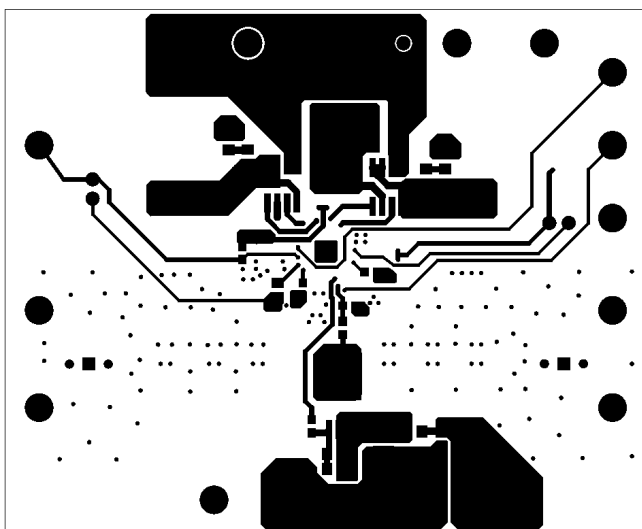

LAYER 4

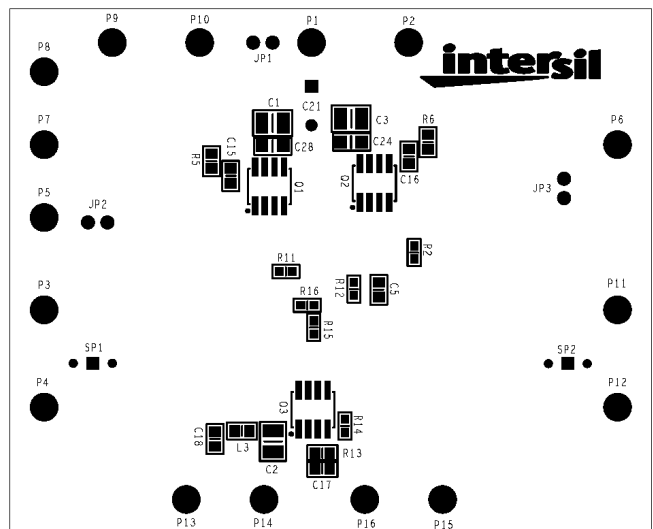

BOTTOM SILK

ISL6402EVAL4 Schematic

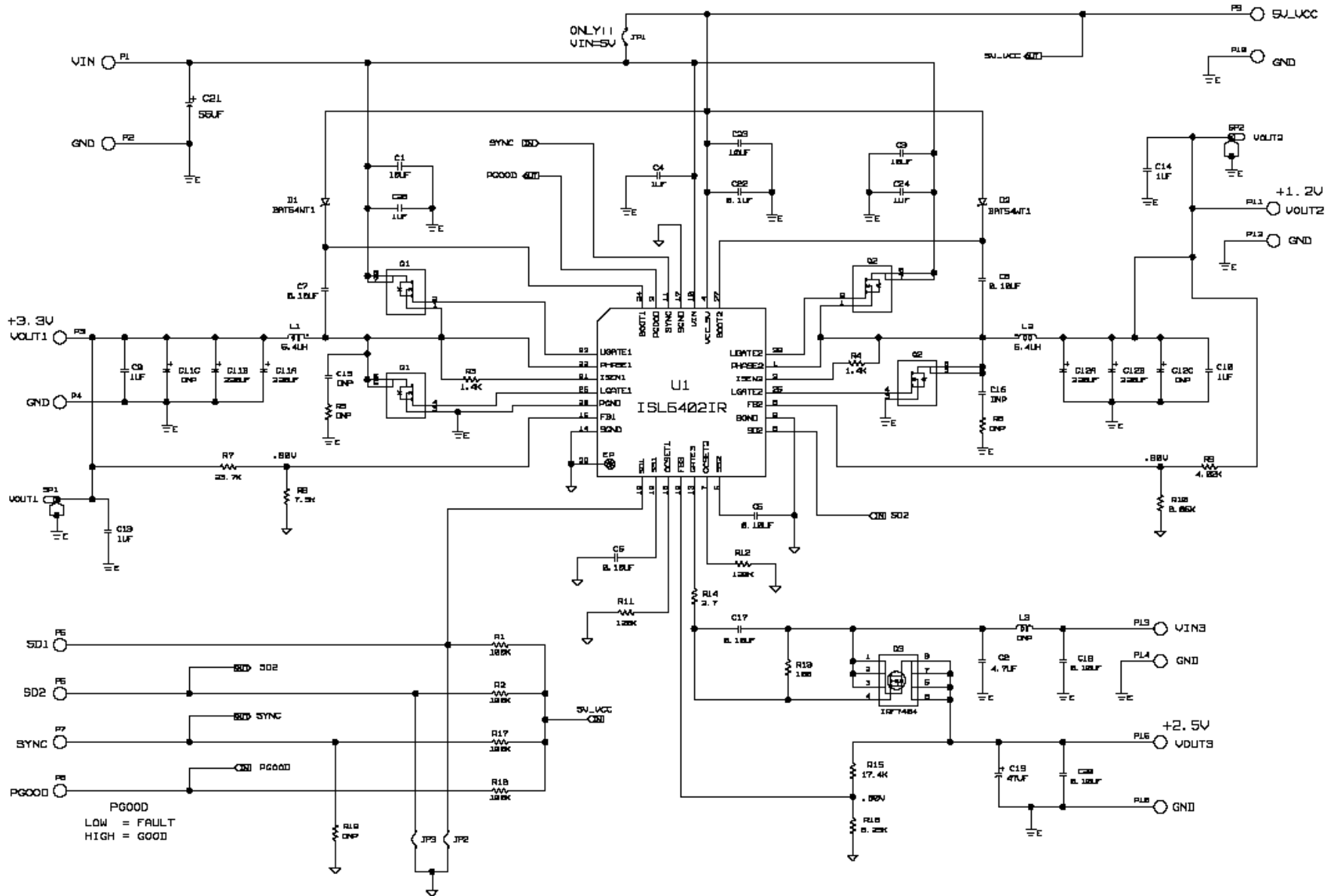

Application Note 1130

ISL6402EVAL4 Bill of Materials

ITEM	REFERENCE	QTY	PART NUMBER	PART TYPE	DESCRIPTION	PKG.	VENDOR
1	U1	1	ISL6402IR	IC, Linear	Dual PWM Controller, 300kHz	28 QFN	Intersil
2	D1, D2	2	BAT54WT1	Diode, Schottky	30V, 200mA	SOT-323	On Semi
3	Q1, Q2	2	FDS6990S	MOSFET, Dual	N-Chan, 30V, 7.5A, 0.022Ω	SOIC-8	Fairchild
4	Q3	1	IRF7404	MOSFET, Power, HEXFET	P-Chan, 20V, 6.7A, 0.04Ω	SOIC-8	IR
5	L1, L2	2	ETQP6F6R4HFA	Power Choke Coil	6.4μH, 30%, 6.2A	PCC-N6	PANASONIC
6	L3	1	BLM21PG300SN1	Ferrite Bead		SM_0805	Murata
7	C1, C3	2	TMK325BJ106KM	Capacitor, Ceramic, X5R	10μF, 10%, 25V	SM_1210	Taiyo Yuden/Generic
8	C2	1	12103D475KAT2A	Capacitor, Ceramic, XR5	4.7μF, 10%, 25V	SM_1210	AVX/Generic
9	C4, C24, C28	3	12063C105KAT2A	Capacitor, Ceramic, X7R	1.0μF, 10%, 25V	SM_1206	AVX/Generic
10	C9, C10, C13, C14	4	0805ZC105KAT2A	Capacitor, Ceramic, X7R	1.0μF, 10%, 10V	SM_0805	AVX/Generic
11	C11A, C11B, C12A, C12B	4	10TPB220M	Capacitor, Tantalum	220μF, 20%, 10V	CASE-D4	SANYO
12	C11C, C12C (DNP)	2		Capacitor, Tantalum		CASE-D4	SANYO
13	C15, C16 (DNP)	2		Capacitor, Ceramic		SM_0805	AVX/Generic
14	C5, C6, C7, C8, C17, C18, C20	7	08053C104KAT2A	Capacitor, Ceramic, X7R	0.1μF, 10%, 25V	SM_0805	AVX/Generic
15	C19	1	16TPB47M	Capacitor, Tantalum	47μF, 20%, 16V	CASE-D3	SANYO
16	C21	1	25SP56M	Capacitor, Aluminum	56μF, 20%, 25V	Radial	SANYO
17	C22	1	0603YC104KAT2A	Capacitor, Ceramic, X7R	0.1μF, 10%, 16V	SM_0603	AVX/Generic
18	C23	1	1210ZC106MAT2A	Capacitor, Ceramic, X7R	10μF, 20%, 10V	SM_1210	AVX/Generic
19	R1, R2, R17, R18	4		Resistor, Film	100kΩ, 1%, 0.1W	SM_0603	Panasonic/Generic
20	R3, R4	2		Resistor, Film	1.4kΩ, 1%, 0.1W	SM_0603	Panasonic/Generic
21	R5, R6 (DNP)	0		Resistor, Film	TBD	SM_0805	Panasonic/Generic
22	R7	1		Resistor, Film	23.7kΩ, 1%, 1/16W	SM_0603	Panasonic/Generic
23	R8	1		Resistor, Film	7.50kΩ, 1%, 1/16W	SM_0603	Panasonic/Generic
24	R9	1		Resistor, Film	4.02kΩ, 1%, 1/16W	SM_0603	Panasonic/Generic
25	R10	1		Resistor, Film	8.06kΩ, 1%, 1/16W	SM_0603	Panasonic/Generic
26	R11, R12	2		Resistor, Film	120kΩ, 1%, 1/16W	SM_0603	Panasonic/Generic
27	R13	1		Resistor, Film	100Ω, 1%, 0.1W	SM_0805	Panasonic/Generic
28	R14	1		Resistor, Film	2.7Ω, 5%, 1/16W	SM_0603	Panasonic/Generic
29	R15	1		Resistor, Film	17.4kΩ, 1%, 1/16W	SM_0603	Panasonic/Generic
30	R16	1		Resistor, Film	8.25kΩ, 1%, 1/16W	SM_0603	Panasonic/Generic
31	R19 (DNP)	1		Resistor, Film		SM_0603	Panasonic/Generic
	Misc.						
32	P1 - P16	16	1514-2	Turret Post	Terminal post, through hole, 1/4 inch tall	PTH	
33	JP1, JP2, JP3	3	68000-236-1X2	Header	1X2 Break Strip GOLD	1X2@.1"	
34	JP1 (DNP)	0	S9001-ND	Jumper	2 pin jumper		Digikey
35	JP2 - JP3	2	S9001-ND	Jumper	2 pin jumper		Digikey

Intersil Corporation reserves the right to make changes in circuit design, software and/or specifications at any time without notice. Accordingly, the reader is cautioned to verify that the Application Note or Technical Brief is current before proceeding.

For information regarding Intersil Corporation and its products, see www.intersil.com

ISL6402EVAL4 Layout

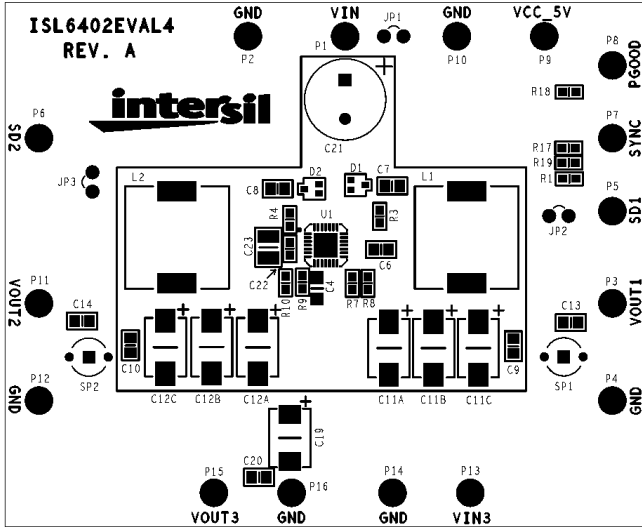

TOP SILK

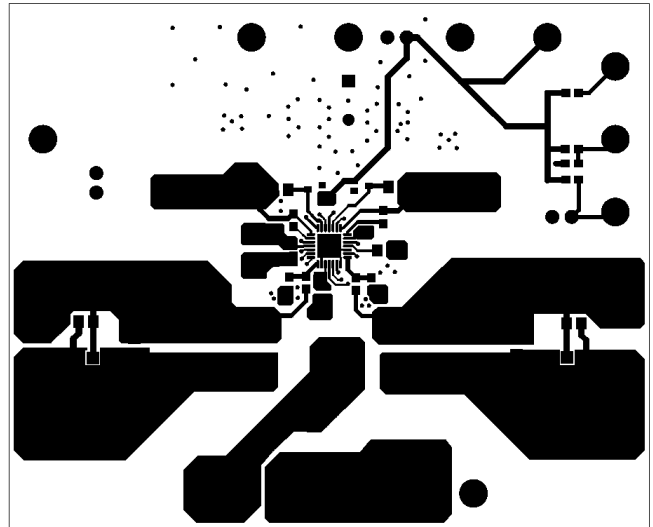

LAYER 1

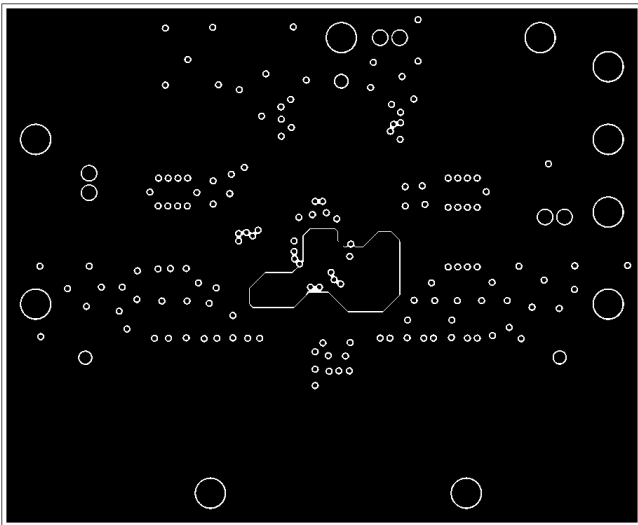

LAYER 2

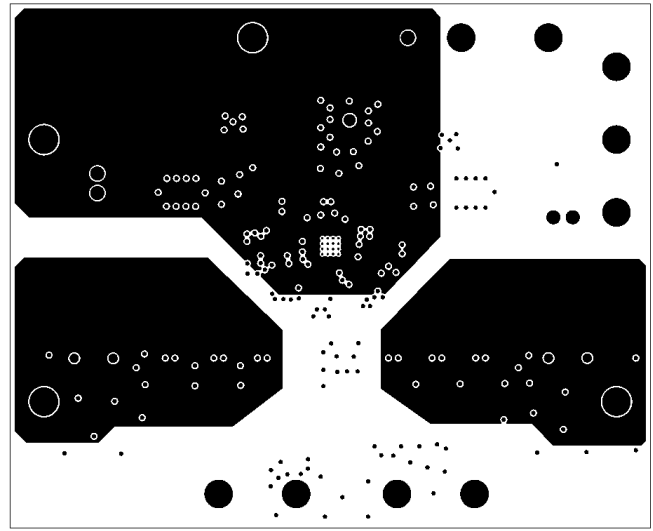

LAYER 3

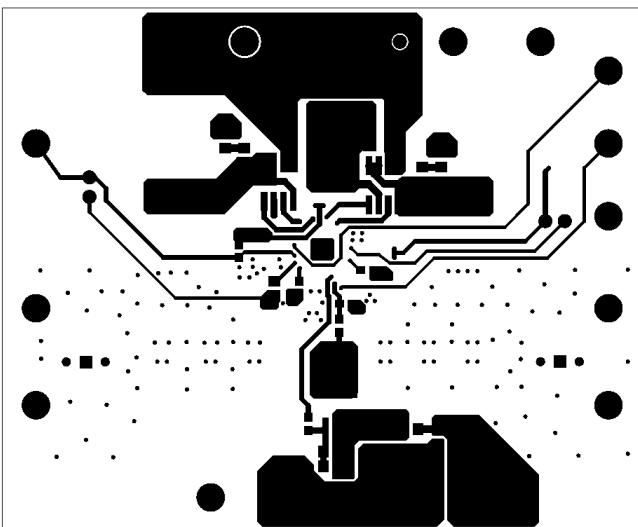

LAYER 4

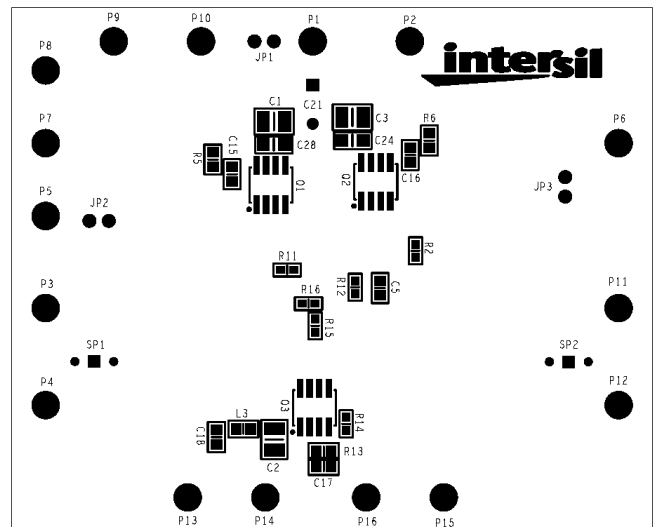

BOTTOM SILK