



EVQ4415A-QB-00A

High-Efficiency, 1.5A, 36V, 2.2MHz, Synchronous, Step Down Converter Evaluation Board

DESCRIPTION

The EVQ4415A-QB-00A is an evaluation board for the MP/MPQ4415AGQB.

MP/MPQ4415AGQB is a synchronous, rectified, step-down, switch-mode converter with built-in power MOSFETs and one input bypass capacitor. It offers a very compact solution to achieve a 1.5A of continuous output current with excellent load and line regulation over a wide input supply range. The MP/MPQ4415A uses synchronous mode operation to achieve high efficiency over the output current load range.

The EVQ4415A-QB-00A is a fully assembled and tested evaluation board, it generates 3.3V output voltage at load current up to 1.5A from a 4V to 36V input range.

ELECTRICAL SPECIFICATIONS

Parameter	Symbol	Value	Units
Input Voltage	V_{IN}	4 – 36	V
Output Voltage	V_{OUT}	3.3	V
Output Current	I_{OUT}	1.5	A

FEATURES

- Wide 4V to 36V Operating Input Range
- 1.5A Continuous Load Current
- 90mΩ High-Side, 50mΩ Low-Side Internal Power MOSFETs
- High-Efficiency Synchronous Mode Operation
- Default 2.2MHz Switching Frequency
- 450kHz to 2.2MHz Frequency Sync
- Forced Continuous Conduction Mode (CCM)
- Internal Soft Start (SS)
- Power Good (PG) Indicator
- Over-Current Protection (OCP) with Valley-Current Detection and Hiccup
- Thermal Shutdown
- Output Adjustable from 0.8V
- Available in a QFN-13 (2.5mmx3mm) Package
- CISPR25 Class 5 Compliant
- AEC-Q100 Grade-1

APPLICATIONS

- Automotive
- Industrial Control Systems
- Medical and Imaging Equipment
- Telecom Applications
- Distributed Power Systems

All MPS parts are lead-free, halogen free, and adhere to the RoHS directive. For MPS green status, please visit MPS website under Quality Assurance. "MPS" and "The Future of Analog IC Technology" are Registered Trademarks of Monolithic Power Systems, Inc.

EVALUATION BOARD



(L x W x H) 2.5" x 2.5" x 0.4"
(6.4cm x 6.4cm x 1.0cm)

Board Number	MPS IC Number
EVQ4415A-QB-00A	MP/MPQ4415AGQB

Efficiency vs. Load Current
 $V_{OUT}=3.3V$

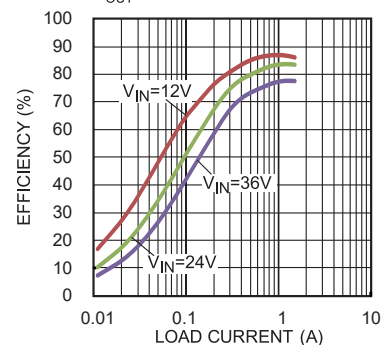

EVALUATION BOARD SCHEMATIC

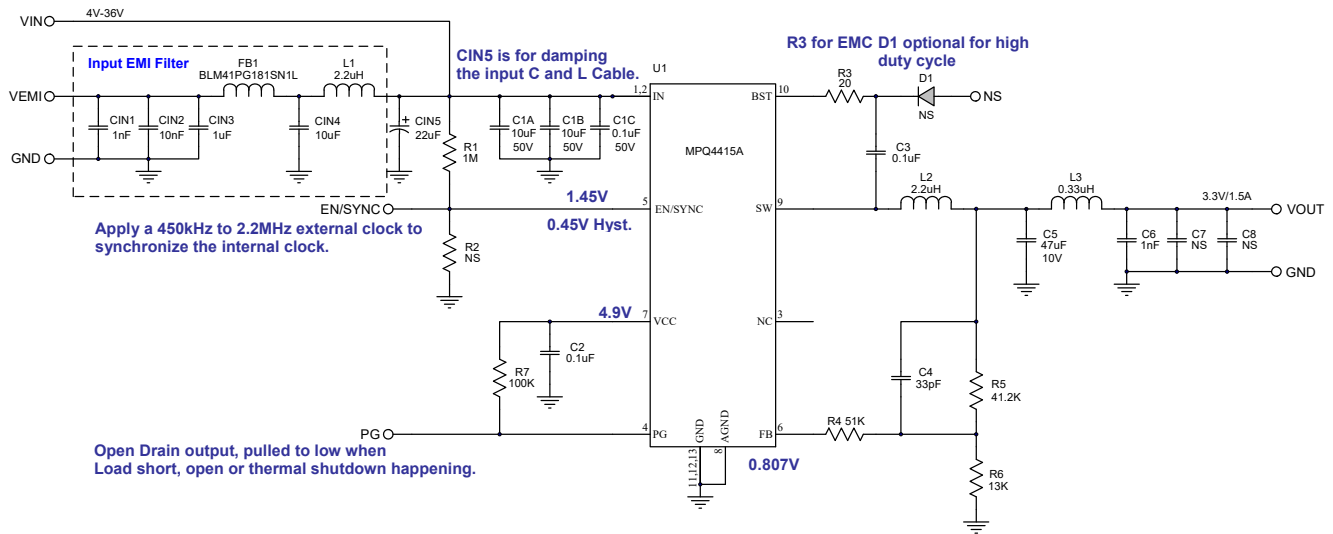

Package reference

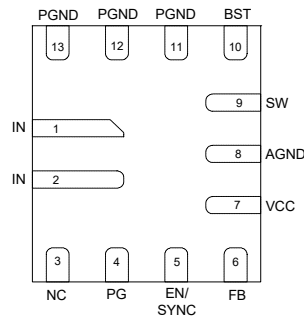

Reference for FB divider selection

Vo(V)	R6(kΩ)	R5(kΩ)
5	41.2(1%)	7.68(1%)
2.5	41.2(1%)	19.6(1%)
1.8	41.2(1%)	33.5(1%)

EVQ4415A-QB-00A BILL OF MATERIALS

Qty	Ref	Value	Description	Package	Manufacturer	Part Number
1	CIN1	1nF	Ceramic Cap., 50V, X7R	0603	muRata	GRM188R71H102KA01D
1	CIN2	10nF	Ceramic Cap., 50V, X7R	0603	muRata	GRM188R71H103JA01D
1	CIN3	1uF	Ceramic Cap., 50V, X7R	1206	muRata	GRM31MR71H105KA88L
1	CIN4	10uF	Ceramic Cap., 50V, X7R	1210	muRata	GRM32ER71H106KA12L
1	CIN5	22uF	Aluminium Cap; 63V	SMD	JiangHai	VTD-63V22
2	C1A, C1B	10μF	Ceramic Cap., 50V, X5R	1206	muRata	GRM31CR61H106KA12L
1	C1C	0.1μF	Ceramic Cap., 50V, X7R	0603	muRata	GRM188R71H104KA93D
2	C2, C3	0.1μF	Ceramic Cap., 16V, X7R	0603	muRata	GRM188R71C104KA01D
1	C4	33pF	Ceramic Cap., 50V, C0G	0603	muRata	GRM1885C1H330JA01D
1	C5	47μF	Ceramic Cap., 10V, X5R	1210	muRata	GRM32ER61A476KE20L
1	C6	1nF	Ceramic Cap., 16V, X7R	0603	muRata	GRM188R71C102KA01D
2	C7, C8	NS				
1	D1	NS				
1	FB1		Magnetic Bead	1806	muRata	BLM41PG181SN1L
2	L1, L2	2.2μH	Inductor, 70mOhm DCR, 3.5A	SMD	Cyntec	VCTA25201B-2R2MS6-89
1	L3	0.33μH	Inductor, 19mOhm DCR, 5.9A	SMD	Cyntec	VCTA20161B-R33MS6-89
1	R1	1M	Film Res., 5%	0603	Yageo	RC0603JR-071ML
1	R3	20	Film Res., 1%	0603	Yageo	RC0603FR-0720RL
1	R4	51k	Film Res., 1%	0603	Yageo	RC0603FR-0751KL
1	R5	13k	Film Res., 1%	0603	Yageo	RC0603FR-0713KL
1	R6	41.2k	Film Res., 1%	0603	Yageo	RC0603FR-0741K2L
1	R7	100k	Film Res., 1%	0603	Yageo	RC0603FR-07100KL
1	R2	NS				
1	U1		Step-Down Regulator	QFN13(2X3)	MPS	MPQ4415AGQB
5	VIN, VEMI, GND, GND, VOU T		2.0 Golden Pin		HZ	
4	PG, GND, EN/ SYN C, GND		2.54mm Test Pin		HZ	

TYPICAL CHARACTERISTICS

Quiescent Current vs. Temperature

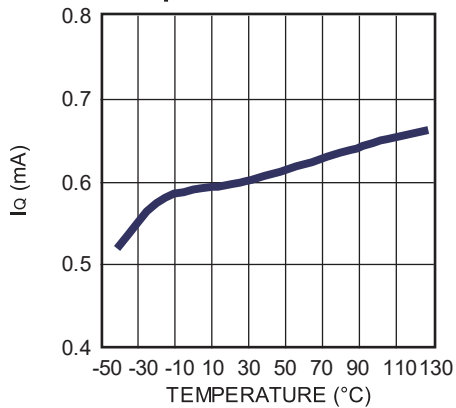

Shutdown Current vs. Temperature

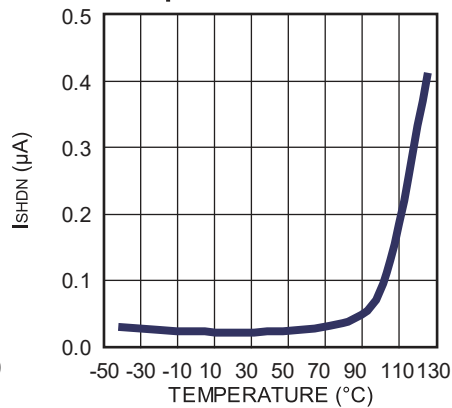

V_{IN} UVLO Threshold vs. Temperature

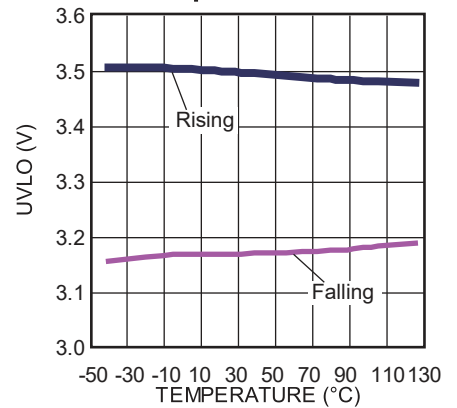

Feedback Reference vs. Temperature

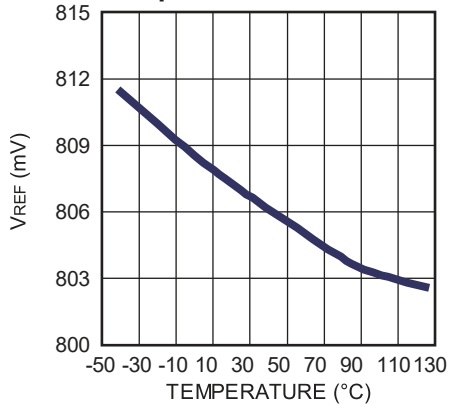

Switching Frequency vs. Temperature

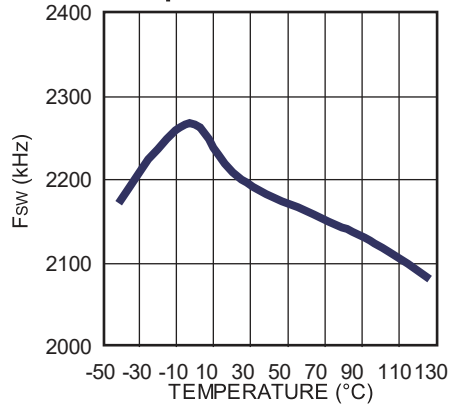

Max Duty Cycle vs. Temperature

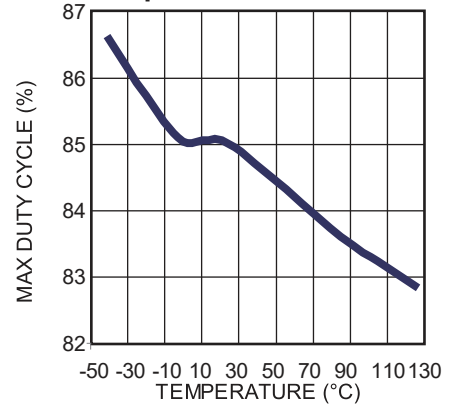

Current Limit vs. Temperature

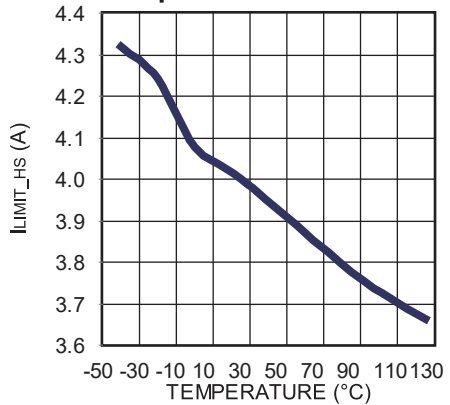

Valley Current Limit vs. Temperature

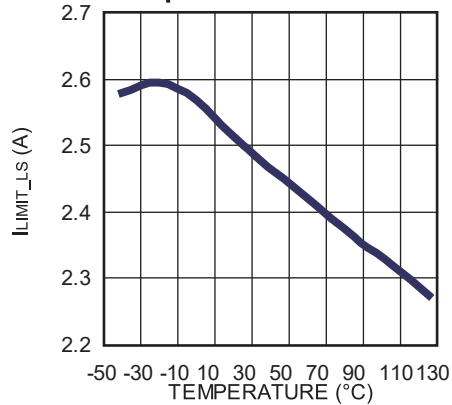

Reverse Current Limit vs. Temperature

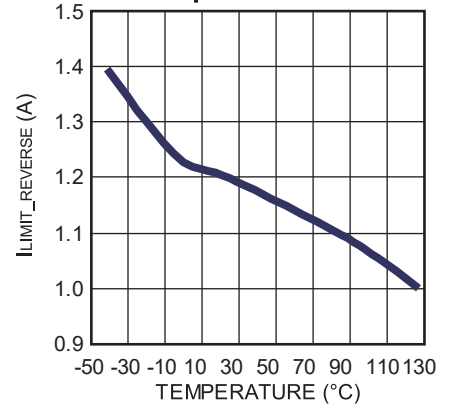

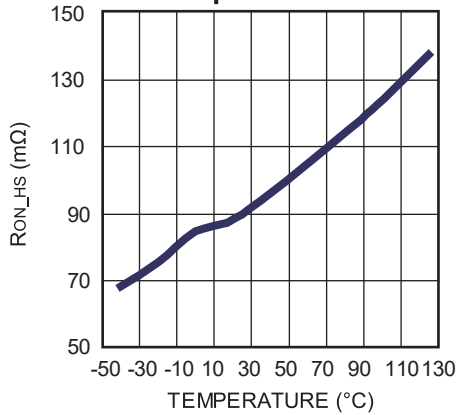
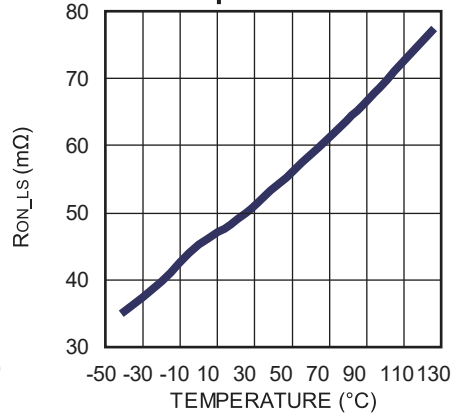
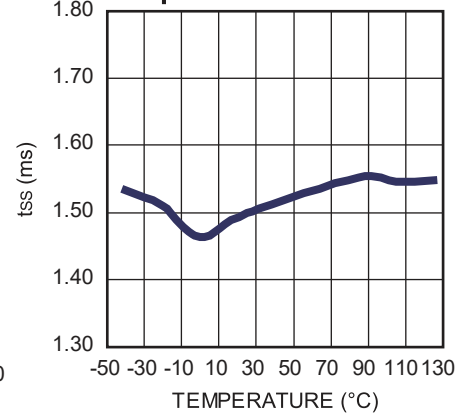
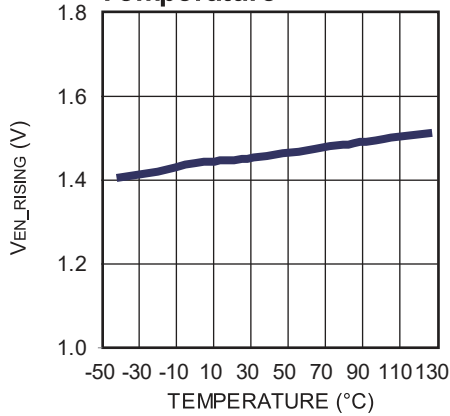
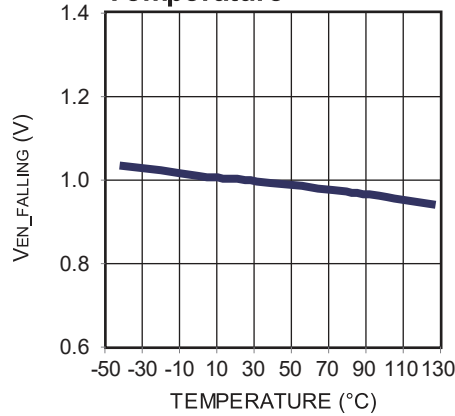
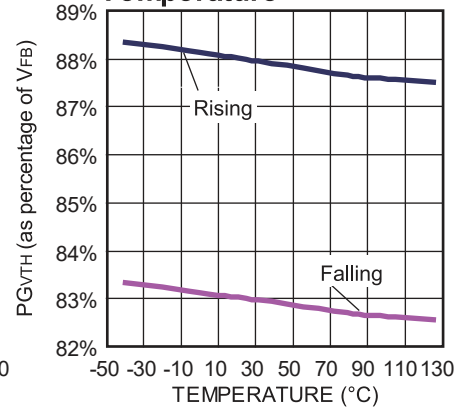
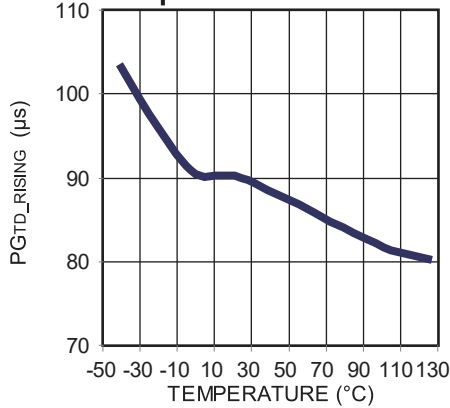
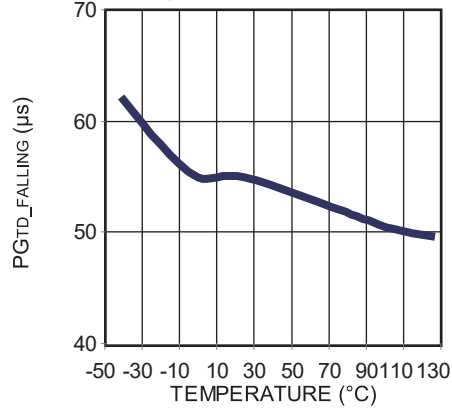
TYPICAL CHARACTERISTICS (continued)
HS-FET On Resistance vs. Temperature

LS-FET On Resistance vs. Temperature

Soft-Start Time vs. Temperature

EN Rising Threshold vs. Temperature

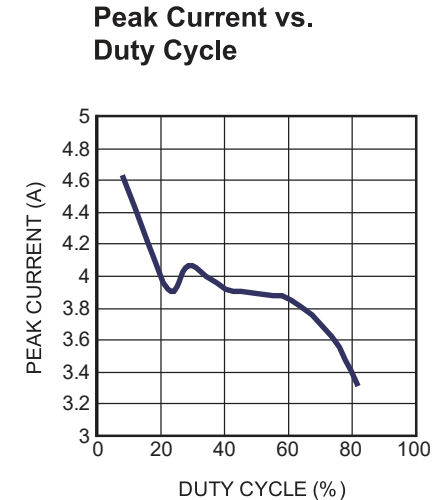
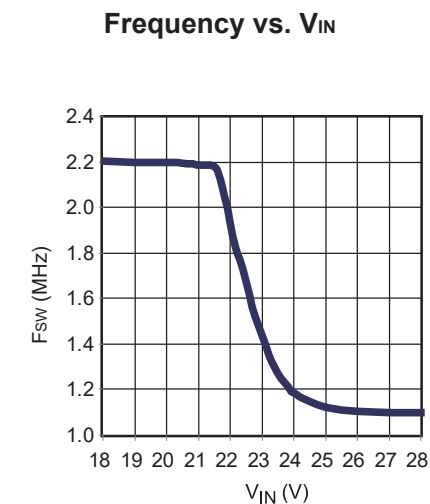
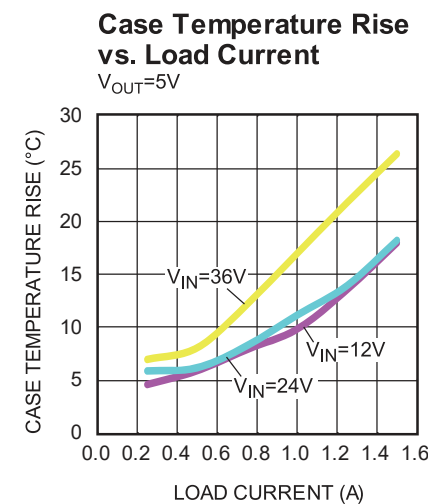
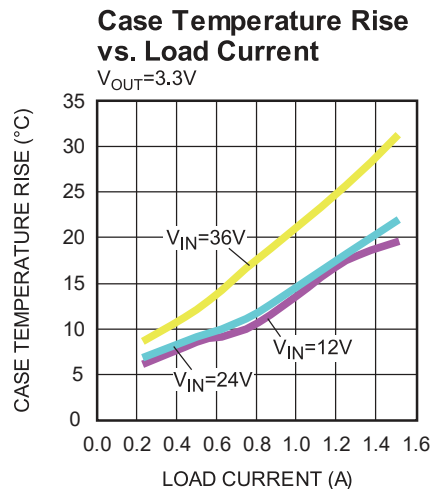
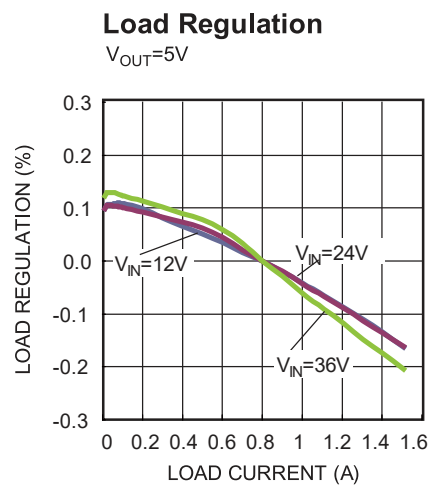
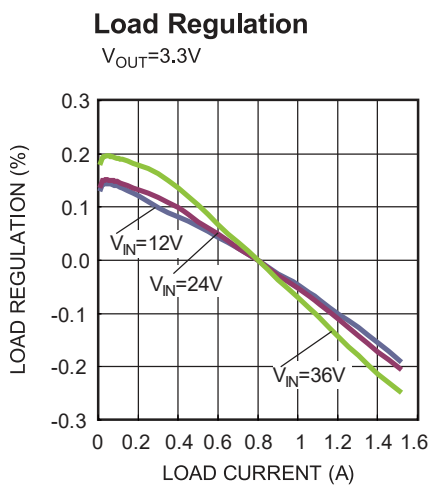
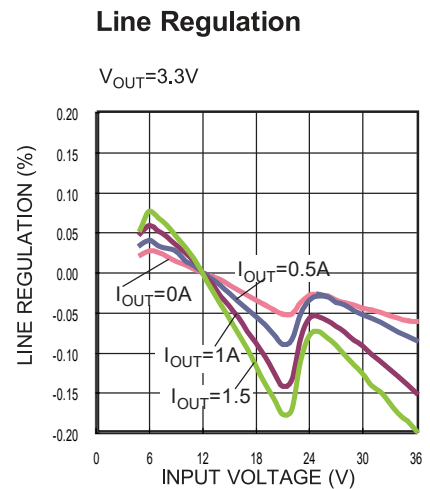
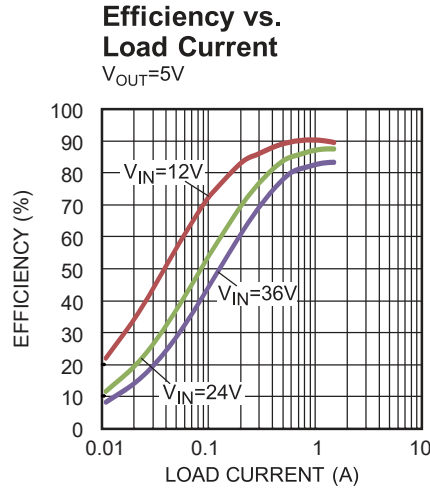
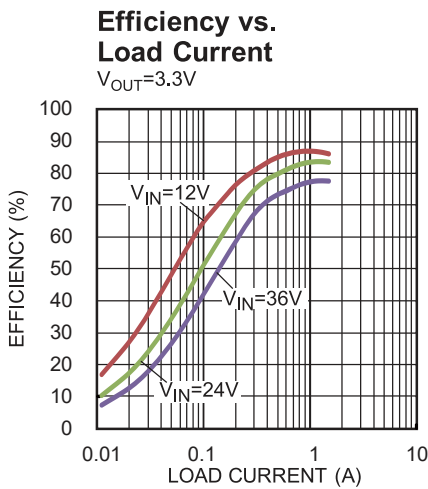
EN Falling Threshold vs. Temperature

PG Threshold vs. Temperature

PG Rising Delay vs. Temperature

PG Falling Delay vs. Temperature

EVB TEST RESULTS

Performance waveforms are tested on the evaluation board.

$V_{IN} = 12V$, $V_{OUT} = 3.3V$, $L = 2.2\mu H$, $F_{SW} = 2.2MHz$, $T_A = +25^\circ C$, unless otherwise noted.



EVB TEST RESULTS (continued)

Performance waveforms are tested on the evaluation board.

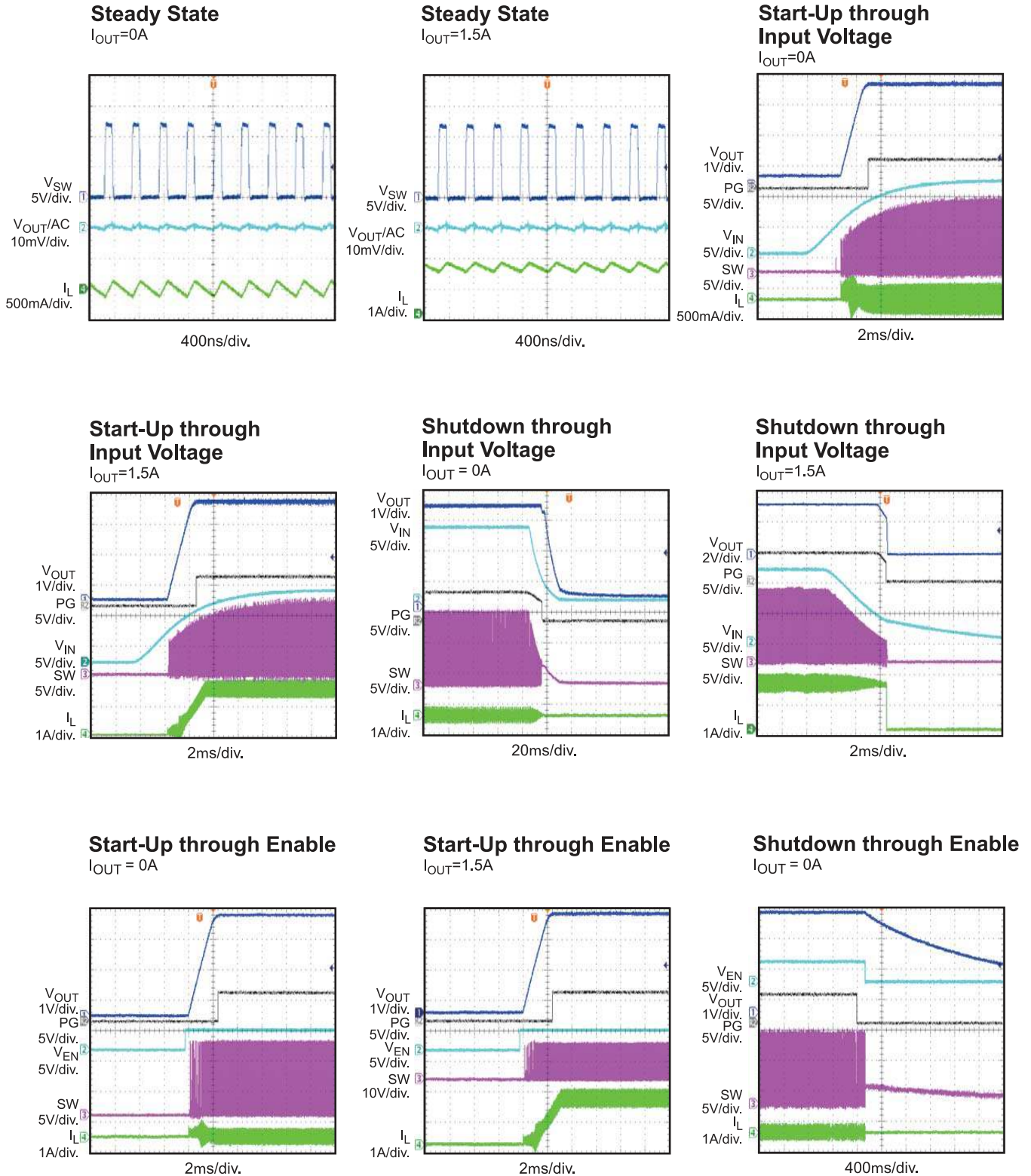
 $V_{IN} = 12V$, $V_{OUT} = 3.3V$, $L = 2.2\mu H$, $F_{SW} = 2.2MHz$, $T_A = +25^\circ C$, unless otherwise noted.

EVB TEST RESULTS (continued)

Performance waveforms are tested on the evaluation board.

 $V_{IN} = 12V$, $V_{OUT} = 3.3V$, $L = 2.2\mu H$, $F_{SW} = 2.2MHz$, $T_A = +25^\circ C$, unless otherwise noted.

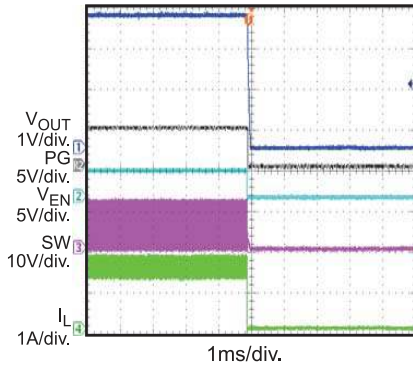
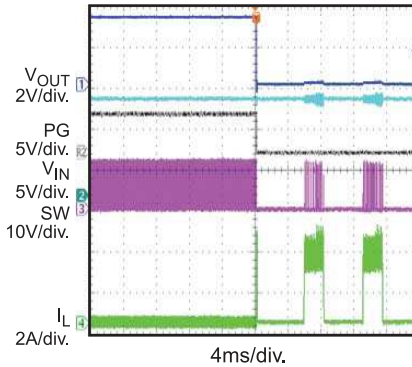
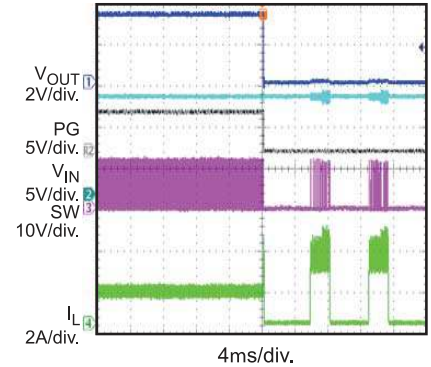
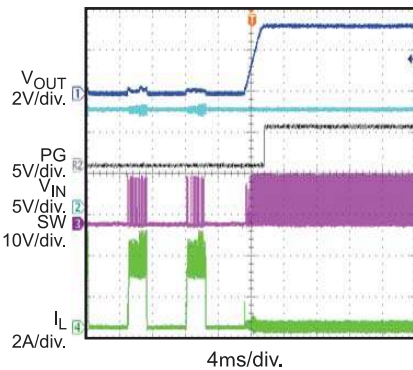
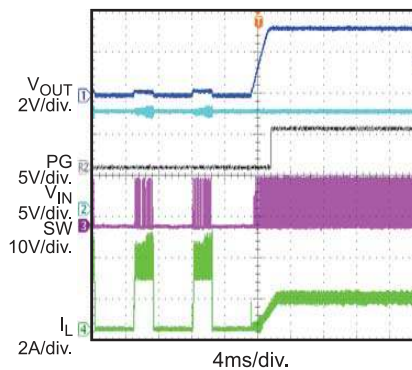
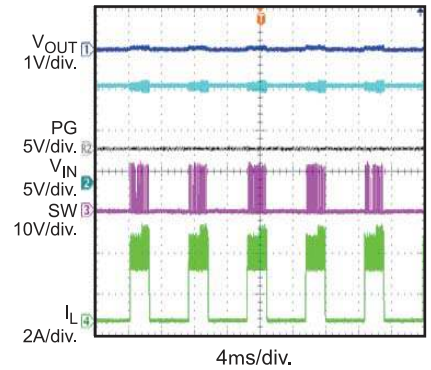
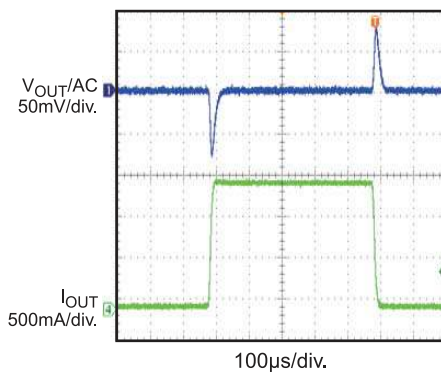
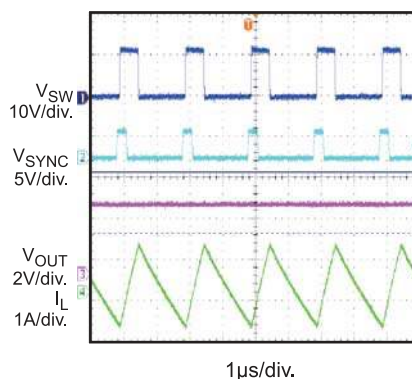
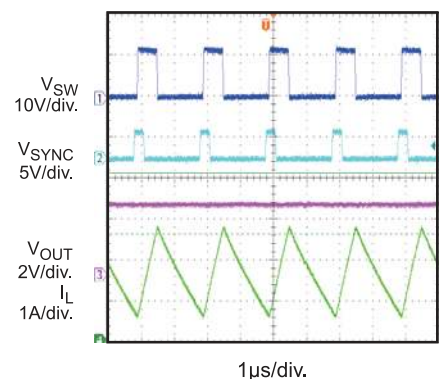
Shutdown through Enable
 $I_{OUT} = 1.5A$

SCP Entry
 $I_{OUT} = 0A$

SCP Entry
 $I_{OUT} = 1.5A$

SCP Recovery
 $I_{OUT} = 0A$

SCP Recovery
 $I_{OUT} = 1.5A$

SCP Steady State

Load Transient
 $I_{OUT} = 0A - 1.5A$

SYNC Operation
 $f_{SYNC} = 500kHz$, $D = 15\%$, $I_{OUT} = 0A$

SYNC Operation
 $f_{SYNC} = 500kHz$, $D = 15\%$, $I_{OUT} = 1.5A$

PRINTED CIRCUIT BOARD LAYOUT

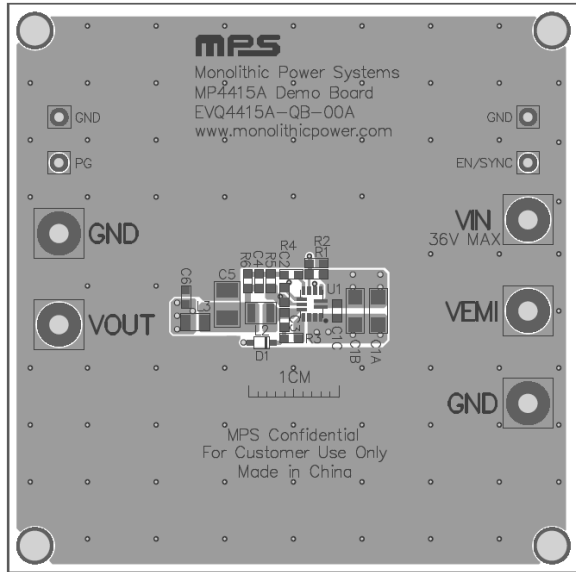

Figure 1: Top Silk Layer and Top Layer

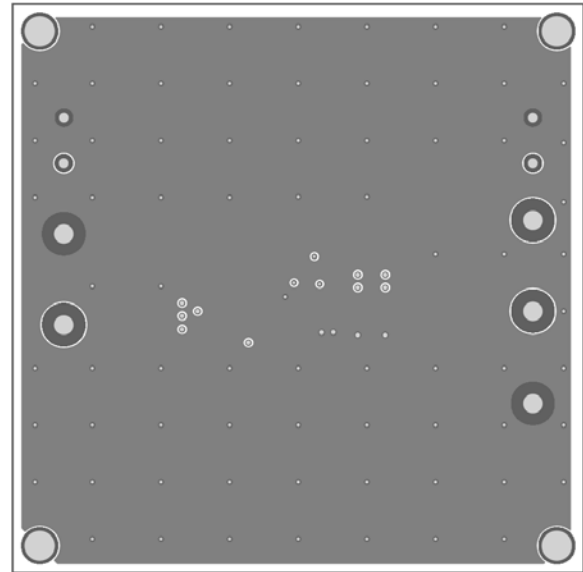

Figure 2: Inner1 Layer

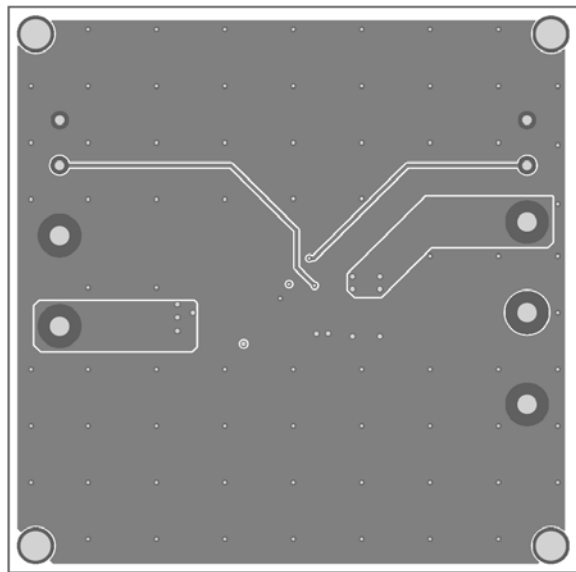

Figure 3: Inner2 Layer

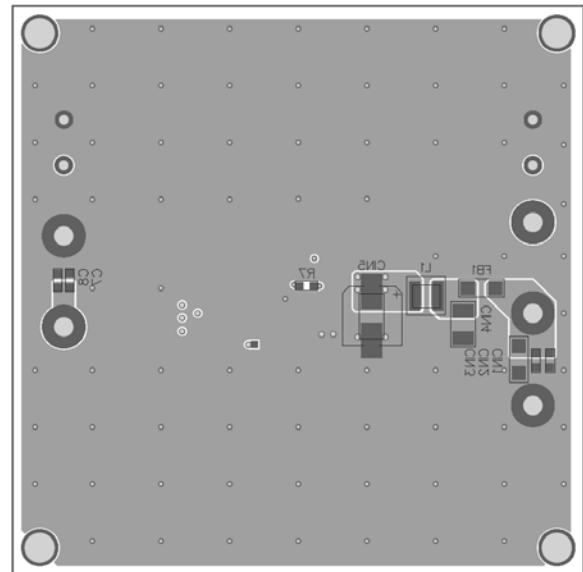

Figure 4: Bottom Silk Layer and Bottom Layer

QUICK START GUIDE

1. Connect the positive and negative terminals of the load to the VOUT and GND pins, respectively.

Be aware that electronic loads represent a negative impedance to the regulator and if set to a too high current will trigger Hiccup mode.

2. Preset the power supply output to between 4 and 36V, and then turn it off.
If longer cables are used between the source and the EVB (>0.5m total), a damping capacitor should be installed at the input terminals. Especially when Vin is ≥ 24V.
3. Connect the positive and negative terminals of the power supply output to the VIN and GND pins, respectively.
4. Turn the power supply on. The MP/MPQ4415AGQB will automatically startup.
5. To use the Enable function, apply a digital input to the EN/Sync pin. Drive EN higher than 1.45V to turn on the regulator, drive EN less than 1V to turn it off.
6. To use the Sync function, apply a 450kHz to 2.2MHz external clock to the EN/Sync pin to synchronize the internal clock rising edge.
7. The output voltage is set by the external resistor divider. The feedback resistor (R_{FB1}) also sets the feedback loop bandwidth with the internal compensation capacitor. Choose R_{FB1} to be around 40kΩ when V_{OUT} ≥ 1V. R_{FB2} can then be calculated with below equation:

$$R_{FB2} = \frac{R_{FB1}}{\frac{V_{OUT}}{0.807V} - 1}$$

8. The T-type network is highly recommended when V_{OUT} is low.

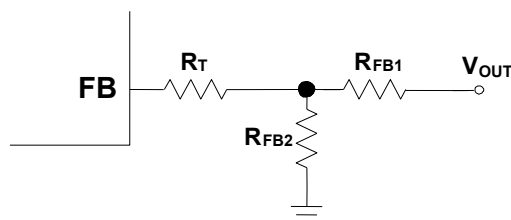

9. R_T + R_{FB1} is used to set the loop bandwidth. The lower R_T + R_{FB1} is, the higher the bandwidth. However, a high bandwidth may cause an insufficient phase margin, resulting in loop unstable. Therefore, a proper R_T value is required to make a trade-off between bandwidth and phase margin. Below table lists the recommended feedback resistor and R_T values for common output voltages.

V _{OUT} (V)	R _{FB1} (kΩ)	R _{FB2} (kΩ)	R _T (kΩ)
3.3	41.2 (1%)	13 (1%)	51 (1%)
5	41.2 (1%)	7.68 (1%)	51 (1%)

Notice: The information in this document is subject to change without notice. Users should warrant and guarantee that third-party Intellectual Property rights are not infringed upon when integrating MPS products into any application. MPS will not assume any legal responsibility for any said applications.