

3-Channel Charge Pump White LED Driver with Low Dropout Current Source

General Description

The RT9373A is a high efficiency and cost effective charge pump white LED driver. It supports up to 3 white LEDs with regulated constant current for uniform intensity. The RT9373A maintains the highest efficiency by utilizing a x1/x1.5/x2 charge pump and low dropout current regulators.

User can easily configure each LED current from 1.25mA to 20mA by a pulse dimming control. The dimming of white LEDs current can be achieved by applying a pulse signal to the EN pin. There are totally 16 steps of current could be set by users.

RT9373A is available in a WQFN3x3-16L package.

Ordering Information

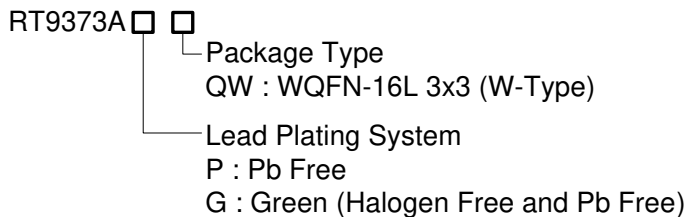

Note :

Richtek products are :

- ▶ RoHS compliant and compatible with the current requirements of IPC/JEDEC J-STD-020.
- ▶ Suitable for use in SnPb or Pb-free soldering processes.

Marking Information

For marking information, contact our sales representative directly or through a Richtek distributor located in your area.

Features

- Very High Efficiency Over 80% of Battery Life
- Support up to 3 White LEDs
- Support Up to 60mA Output Current
- 1% Typical LED Current Matching
- Soft Start Function
- Auto Charge Pump Mode Selection
- 250kHz Fixed Frequency Oscillator
- Output Over Voltage Protection
- 16 Steps Brightness Control
- Low Input Noise and EMI
- RoHS Compliant and 100% Lead (Pb)-Free

Applications

- Mobile Phone, DSC, MP3
- White LED Backlighting
- LCD Display Supply

Pin Configurations

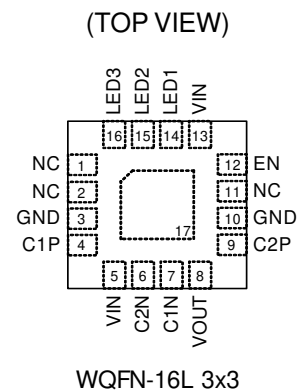

Typical Application Circuit

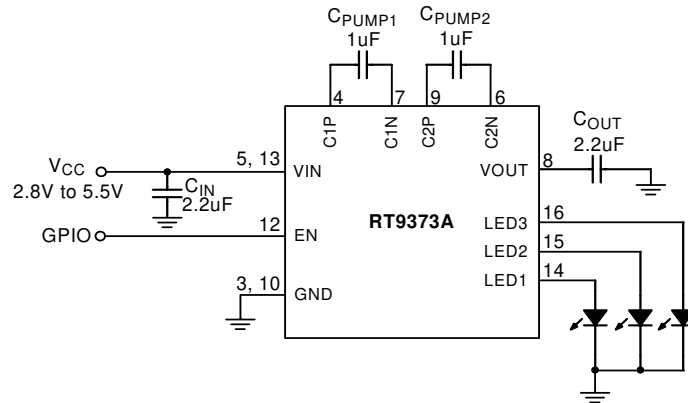

Figure 1. For 3-WLEDs Application Circuit

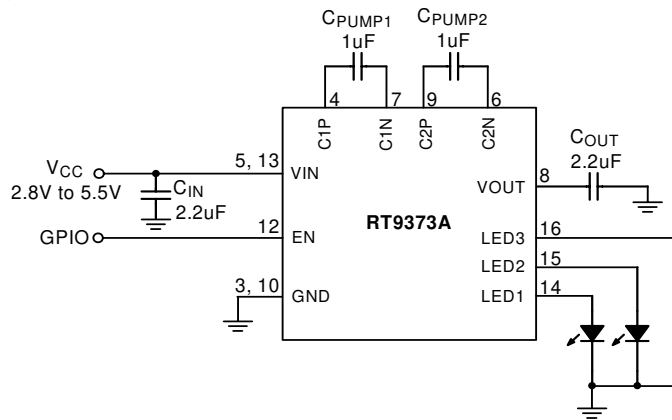
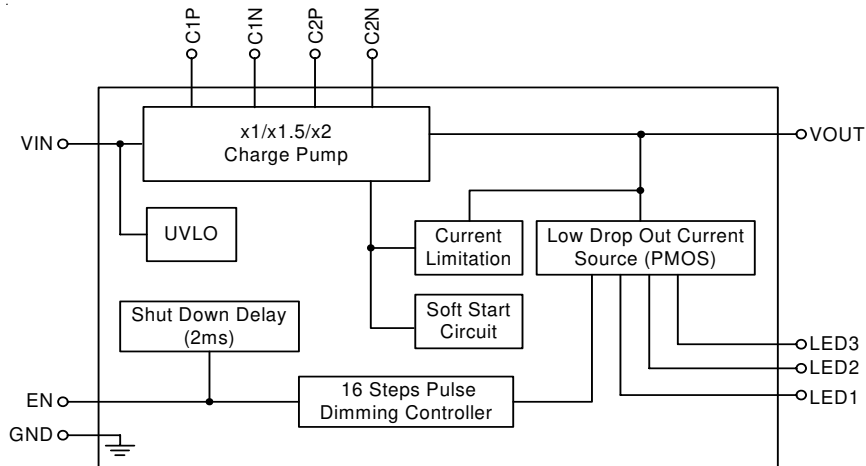

Figure 2. For 2-WLEDs Application Circuit

Functional Pin Description

Pin No.	Pin Name	Pin Function
1, 2, 11, 17 (Exposed Pad)	NC	No Internal Connection.
3	GND	Ground.
4	C1P	Positive Terminal of Bucket Capacitor 1
5	VIN	Power Input Voltage.
6	C2N	Negative Terminal of Bucket Capacitor 2.
7	C1N	Negative Terminal of Bucket Capacitor 1.
8	VOUT	Output Voltage Source.
9	C2P	Positive Terminal of Bucket Capacitor 2.
10	GND	Ground.
12	EN	Chip Enable (Active High). Note that this pin is high impedance.
13	VIN	Power Input Voltage.
14	LED 1	Output Current for LED1. (If not in use, pin should be connected to GND).
15	LED 2	Output Current for LED2. (If not in use, pin should be connected to GND).
16	LED 3	Output Current for LED3. (If not in use, pin should be connected to GND).

Function Block Diagram



Absolute Maximum Ratings (Note 1)

- Supply Input Voltage ----- -0.3V to 6V
- Other I/O Pin Voltage ----- -0.3V to 6V
- Power Dissipation, PD @ T_A = 25°C
 WQFN-16L 3x3 ----- 1.47W
- Package Thermal Resistance (Note 2)
 WQFN-16L 3x3, θ_{JA} ----- 68°C/W
- Junction Temperature ----- 150°C
- Lead Temperature (Soldering, 10 sec.) ----- 260°C
- Storage Temperature Range ----- -40°C to 150°C
- ESD Susceptibility (Note 3)
 HBM (Human Body Mode) ----- 2kV
 MM (Machine Mode) ----- 200V

Recommended Operating Conditions (Note 4)

- Junction Temperature Range ----- -40°C to 125°C
- Ambient Temperature Range ----- -40°C to 85°C

Electrical Characteristics

(V_{IN} = 2.5V to 5.5V, C_{IN} = C_{OUT} = C_{FLY} = 1μF (ESR = 30mΩ), T_A = 25°C, unless otherwise specification)

Parameter	Symbol	Test Condition	Min	Typ	Max	Units
Input						
Input Supply Voltage	V _{IN}		2.8	--	5.0	V
Under-Voltage Lockout Threshold		V _{IN} Rising	1.6	2.1	2.5	V
Under-Voltage Lockout Hysteresis			--	100	--	mV
Quiescent of x1 Mode	I _{Q_x1}	x1 Mode, No Load, All LED pins connected to GND, V _{IN} = 4V	0.5	1	2	mA
Quiescent of x2 Mode	I _{Q_x2}	x2 Mode, No Load, All LED pins floating, V _{IN} = 3.5V	1.5	2.5	5	mA
Shutdown Current		Enable = 0.4V, V _{IN} = 2.8V to 5.5V	0	0.1	10	μA
x1 mode to x1.5 mode Transition Voltage (V _{IN} Falling)	V _{TS_x1.5}	V _F = 3.5V, I _{OUT} = 80mA, I _{LEDx} = 20mA	--	3.75	--	V
x1.5 mode to x2 mode Transition Voltage (V _{IN} Falling)	V _{TS_x2}	V _F = 3.5V, I _{OUT} = 80mA, I _{LEDx} = 20mA	--	3.0	--	V
Hysteresis of Mode Transition			--	150	--	mV
Output						
Current Range of I _{LEDx}		2.8 < V _{IN} < 5.5@V _F = 3.2, I _{OUT} = 60mA	1.25	--	20	mA
I _{LEDx} Accuracy	I _{LED-ERR}	100% Setting	-8	--	+8	%
Current Matching		100% Setting	-5	--	+5	%
Enable						
EN Threshold	Logic-High Voltage	V _{IH}	1.5	--	--	V
	Logic-Low Voltage	V _{IL}	--	--	0.4	V

To be continued

Parameter		Symbol	Test Condition	Min	Typ	Max	Units
EN Low Time for Dimming		T_{IL}		0.5	--	500	us
EN High Time for Dimming		T_{IH}		0.5	--	--	us
EN Current	High Current	I_{IH}	$V_{IH} = V_{IN}$	--	1	10	uA
	Low Current	I_{IL}	$V_{IL} = GND$	--	1	10	uA
EN Low Time for Shut Down		T_{SHDN}	Pulse Dimming	--	2	--	ms
Frequency							
Oscillator Frequency		f_{OSC}		--	250	--	kHz

Note 1. Stresses listed as the above "Absolute Maximum Ratings" may cause permanent damage to the device. These are for stress ratings. Functional operation of the device at these or any other conditions beyond those indicated in the operational sections of the specifications is not implied. Exposure to absolute maximum rating conditions for extended periods may remain possibility to affect device reliability.

Note 2. θ_{JA} is measured in the natural convection at $T_A = 25^\circ C$ on a low effective thermal conductivity test board of JEDEC 51-3 thermal measurement standard.

Note 3. Devices are ESD sensitive. Handling precaution is highly recommended.

Note 4. The device is not guaranteed to function outside its operating conditions.

Typical Operating Characteristics

LED Current vs. Input Voltage

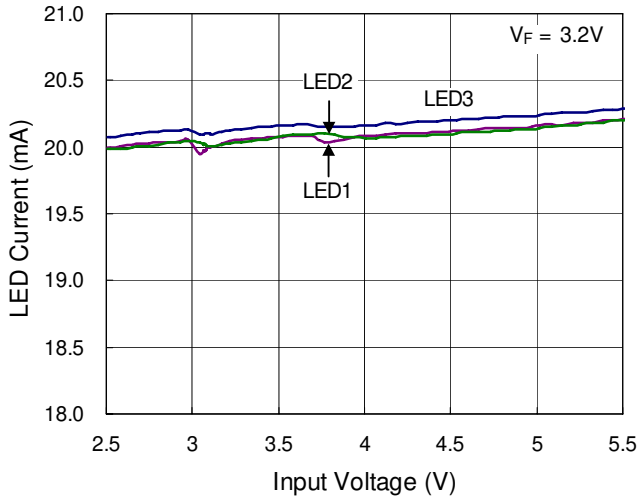

Efficiency vs. Input Voltage

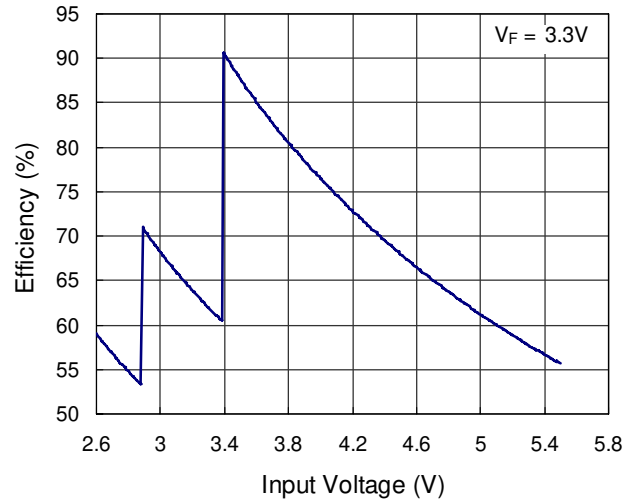

Shutdown Current vs. Input Voltage

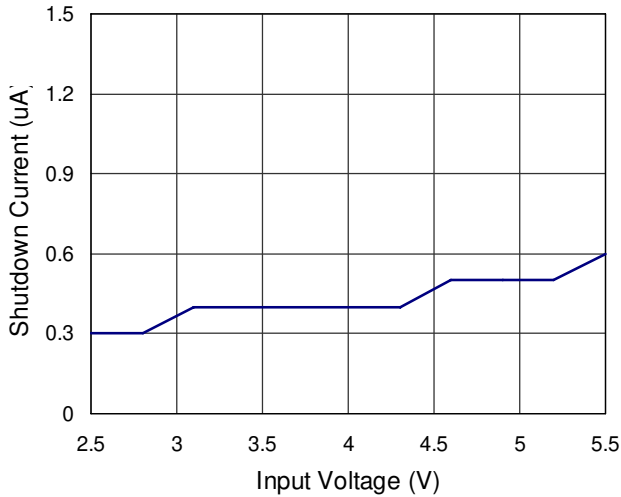

Quiescent Current vs. Input Voltage

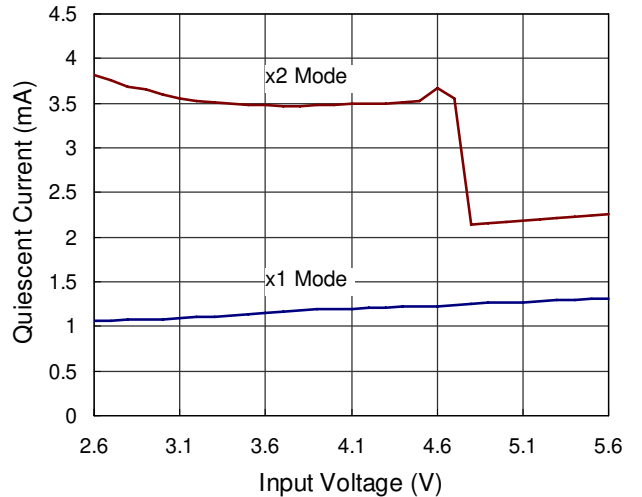

Oscillator Frequency vs. Input Voltage

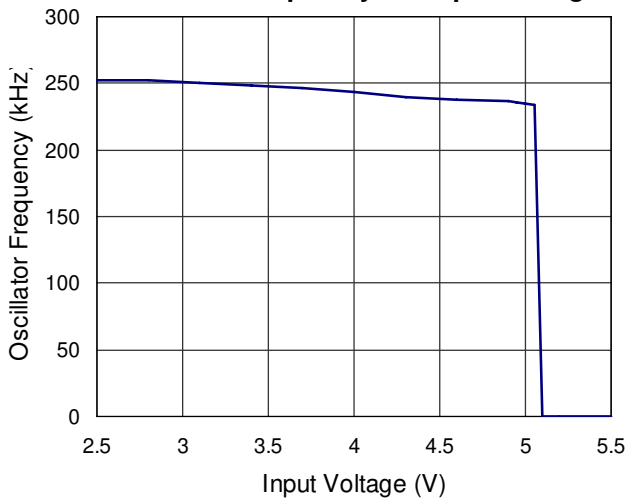

Enable Voltage vs. Input Voltage

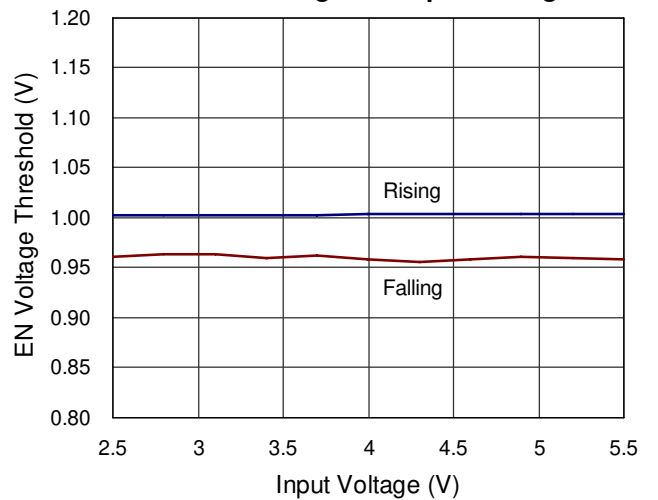

Dimming Operation

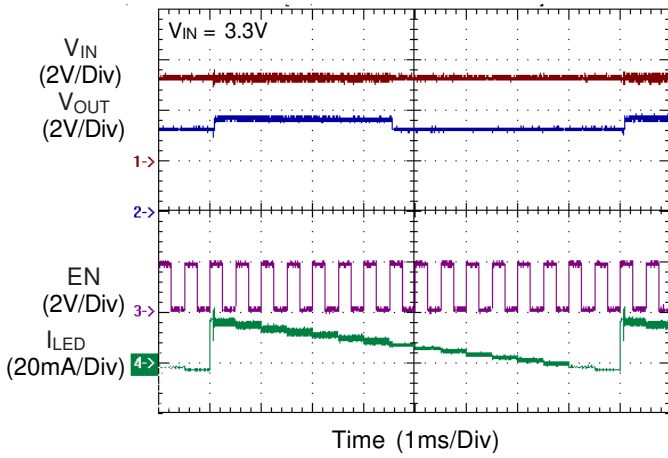

Dimming Operation

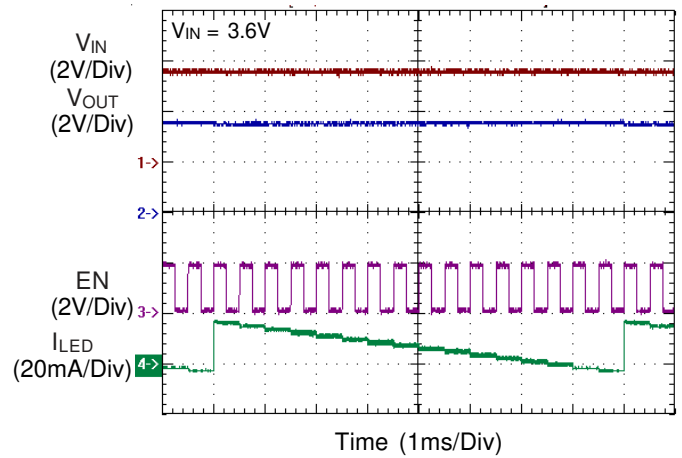

x1 Mode Inrush Current Response

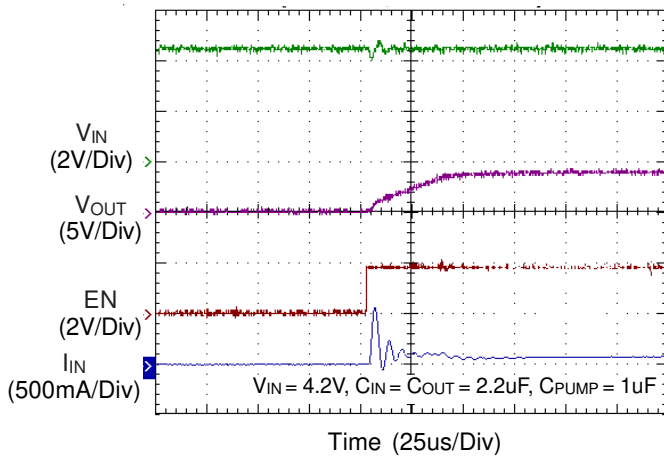

x1.5 Mode Inrush Current Response

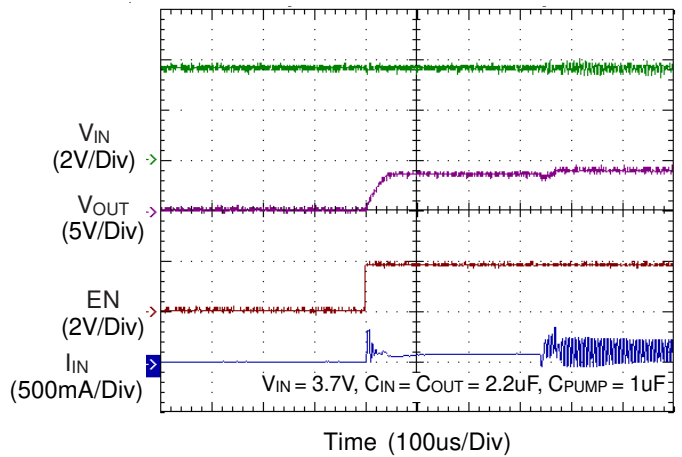

x2 Mode Inrush Current Response

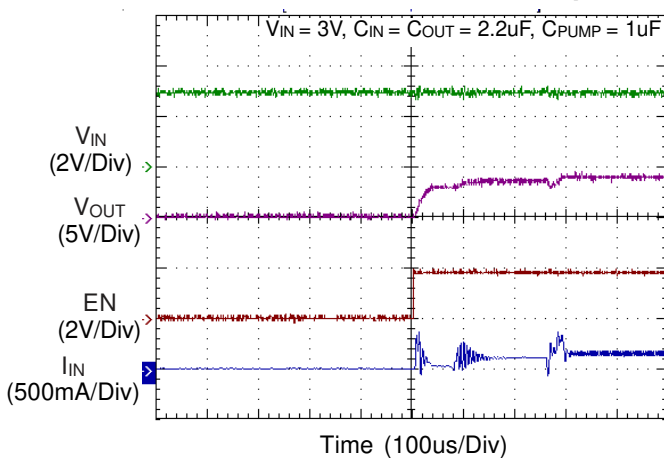

x2 Mode EN Pin Shutdown Response

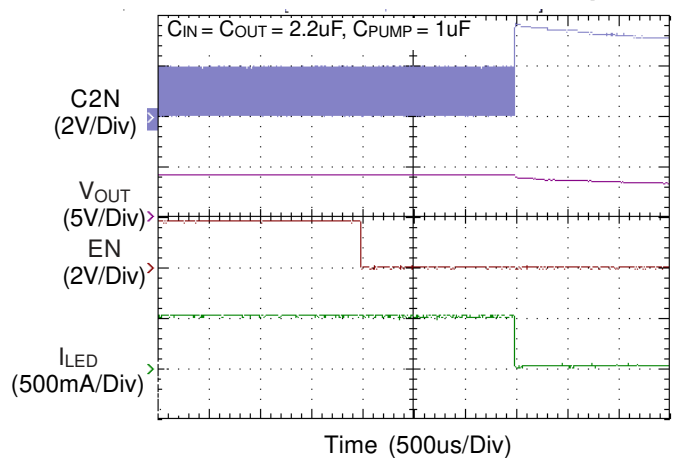

x1.5 Mode Ripple & Spike

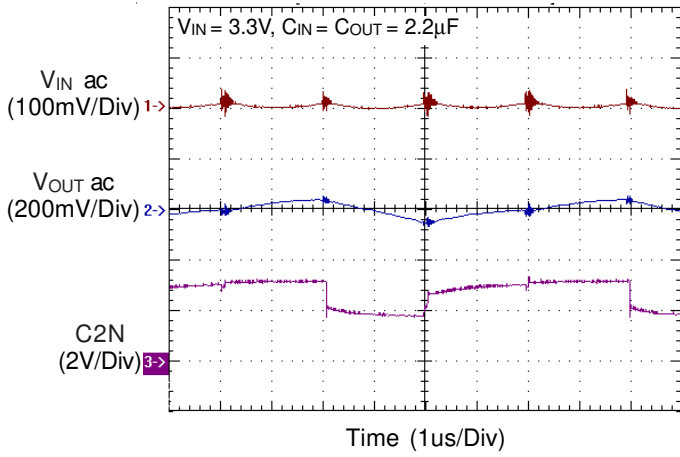

x2 Mode Ripple & Spike

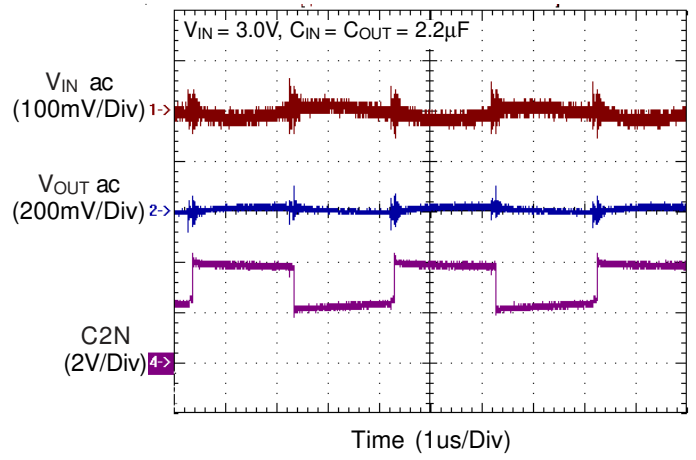

Applications Information

The RT9373A is a high efficiency charge pump white LED driver. It provides 3 channels low dropout voltage current source to regulated 3 white LEDs current. For high efficiency, the RT9373A implements a smart mode transition for charge pump operation. The RT9373A provides pulse dimming function for LED brightness control.

Soft Start

The RT9373A includes a soft start circuit to limit the inrush current at power on and mode switching. Soft start circuit limits the input current before output voltage reaching a desired voltage level. When the soft start off, the RT9373A won't sink spike current from V_{IN} .

Mode Decision

The RT9373A uses a smart mode decision method to select the working mode for maximum efficiency. The charge pump can operation at x1, x1.5 or x2 mode. The mode decision circuit senses the output and LED voltage for up/down selection.

Brightness Control

The RT9373A implements the pulse dimming method being used to control the brightness of white LEDs. The part implements a 4-bit DAC for brightness control. Users can easily configure the LED current from 1.25mA to 20mA by a serial pulse. The maximum LED current is up to

20mA that is sufficient for most application in backlight. The dimming of white LEDs' current can be achieved by applying a pulse signal to the EN pin. There are totally 16 steps of current could be set by users. The detail operation of brightness dimming is showed in the Figure 3.

Selecting Capacitors

To get the better performance of RT9373A, the selecting of peripherally appropriate capacitor and value is very important. These capacitors determine some parameters such as input and output ripple, power efficiency, maximum supply current by charge pump, and start-up time. To reduce the input and output ripple effectively, the low ESR ceramic capacitors are recommended. Generally, to reduce the output ripple, increasing the output capacitance C_{OUT} is necessary. However, this will increase the start-up time of output voltage. For LED driver applications, the input voltage ripple is more important than output ripple. Input ripple is controlled by input capacitor C_{IN} , increasing the value of input capacitance can further reduce the ripple. Practically, the input voltage ripple depends on the power supply' s impedance. If a single input capacitor C_{IN} cannot satisfy the requirement of application, it is necessary to add a low-pass filter. C-R-C filter used to reduce input ripple. The flying capacitor C_{PUMP1} and C_{PUMP2} determine the supply current capability of the charge pump. The lower value will limit the LED' s current at low input voltage.

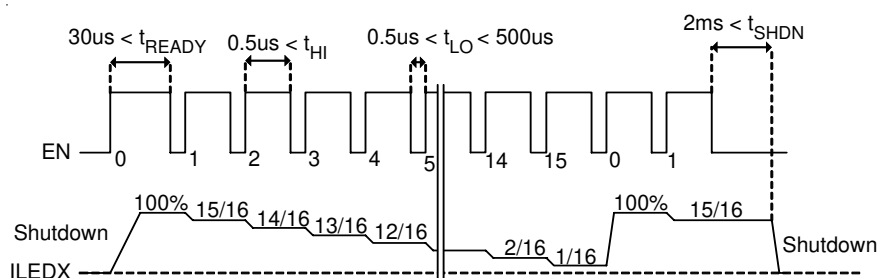

Figure 3. Brightness control by pulse dimming. RT9373A implements 16 steps brightness control

Layout Consideration

The RT9373A is a low dropout current source for white LED driver. Careful PCB layout is necessary. For best performance, place all peripheral components as close to the IC as possible. A short connection is highly recommended. The following guidelines should be strictly followed when designing a PCB layout for the RT9373A.

1. All the traces of LED pins running from chip to LEDs should be wide and short to reduce the parasitic connection resistance.
2. Input capacitor (C_{IN}) should be placed close to V_{IN} (Pin 5) and connected to ground plane. The trace of V_{IN} in the PCB should be placed far away the sensitive devices or shielded by the ground.
3. The GND should be connected to a strong ground plane for heat sinking and noise protection.
4. Output capacitor (C_{OUT}) should be placed close to V_{OUT} and connected to ground plane to reduce noise coupling from charge pump to LEDs.
5. The traces running from pins to flying capacitor should be short and wide to reduce parasitic resistance and prevent noise radiation.

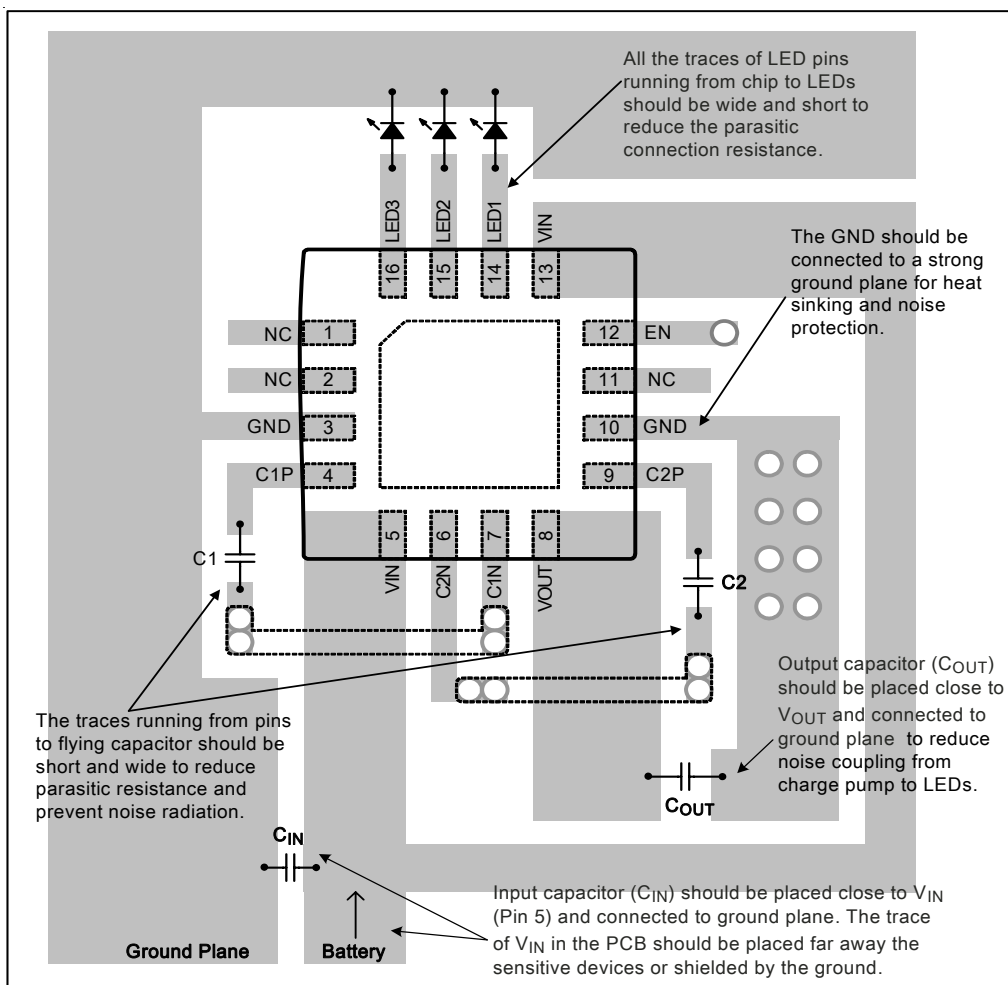
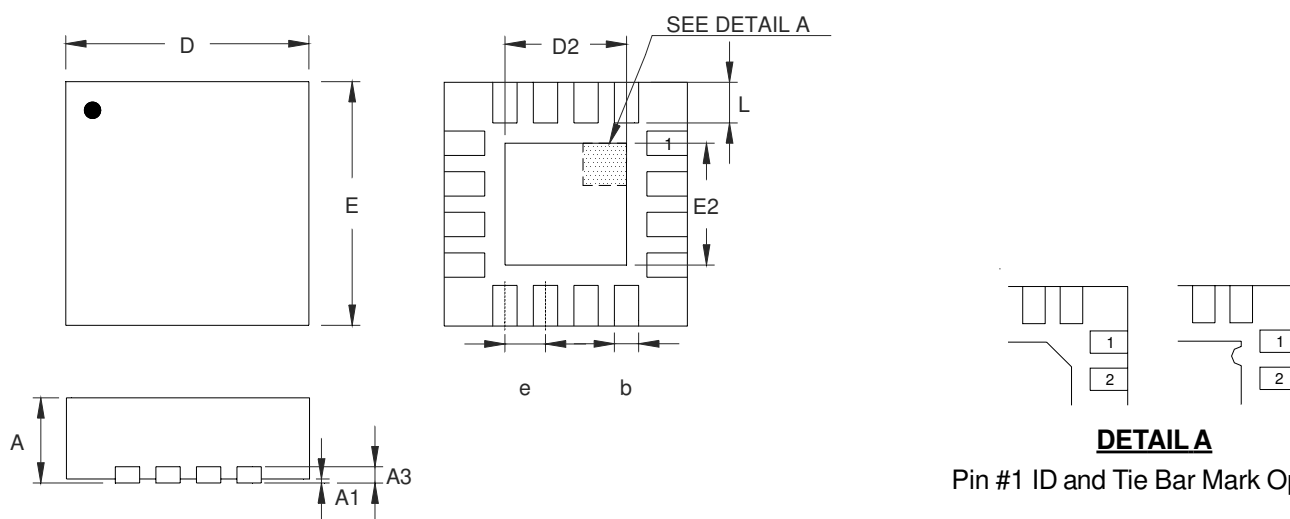

Figure 4. PCB Layout Guide

Outline Dimension



DETAIL A
Pin #1 ID and Tie Bar Mark Options

Note : The configuration of the Pin #1 identifier is optional, but must be located within the zone indicated.

Symbol	Dimensions In Millimeters		Dimensions In Inches	
	Min	Max	Min	Max
A	0.700	0.800	0.028	0.031
A1	0.000	0.050	0.000	0.002
A3	0.175	0.250	0.007	0.010
b	0.180	0.300	0.007	0.012
D	2.950	3.050	0.116	0.120
D2	1.300	1.750	0.051	0.069
E	2.950	3.050	0.116	0.120
E2	1.300	1.750	0.051	0.069
e	0.500		0.020	
L	0.350	0.450	0.014	0.018

W-Type 16L QFN 3x3 Package

Richtek Technology Corporation

Headquarter
5F, No. 20, Taiyuen Street, Chupei City
Hsinchu, Taiwan, R.O.C.
Tel: (8863)5526789 Fax: (8863)5526611

Richtek Technology Corporation

Taipei Office (Marketing)
5F, No. 95, Minchiuan Road, Hsintien City
Taipei County, Taiwan, R.O.C.
Tel: (8862)86672399 Fax: (8862)86672377
Email: marketing@richtek.com

Information that is provided by Richtek Technology Corporation is believed to be accurate and reliable. Richtek reserves the right to make any change in circuit design, specification or other related things if necessary without notice at any time. No third party intellectual property infringement of the applications should be guaranteed by users when integrating Richtek products into any application. No legal responsibility for any said applications is assumed by Richtek.