

2A, 17V, 340/800kHz Synchronous Step-Down Converter

General Description

The RT7250A/B is a high efficiency, monolithic synchronous step-down DC-DC converter that can operate at 340kHz/800kHz, while delivering up to 2A output current from a 4V to 17V input supply. The RT7250A/B's current mode architecture allows the transient response to be optimized. Cycle-by-cycle current limit provides protection against shorted outputs and soft-start eliminates input current surge during start-up. Fault conditions also include output under voltage protection, output over voltage protection and thermal shutdown. The low current (<5µA) shutdown mode provides output disconnection, enabling easy power management in battery-powered systems. The RT7250A/B is available in a SOP-8 (Exposed Pad) package.

Ordering Information

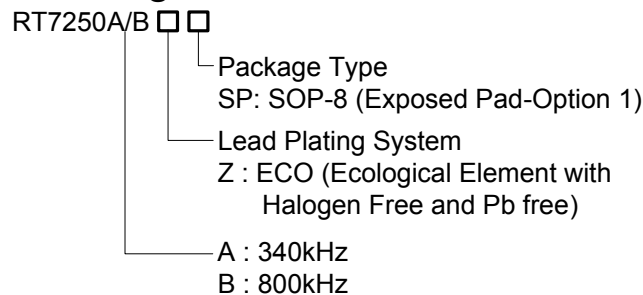

Note :

Richtek products are :

- ▶ RoHS compliant and compatible with the current requirements of IPC/JEDEC J-STD-020.
- ▶ Suitable for use in SnPb or Pb-free soldering processes.

Pin Configuration

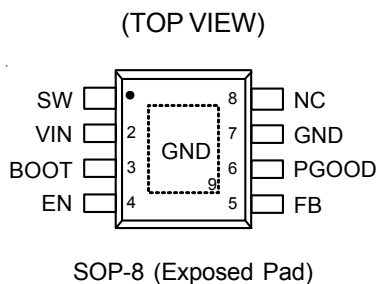

Features

- 4V to 17V Input Voltage Range
- 2A Output Current
- Internal N-MOSFETs
- Current Mode Control
- Fixed Frequency Operation : 340kHz/800kHz
- Output Adjustable from 0.8V to 12V
- Up to 95% Efficiency
- Internal Compensation
- Stable with Low ESR Ceramic Output Capacitors
- Cycle-by-Cycle Over Current Protection
- Input Under Voltage Lockout
- Output Under Voltage Protection
- Output Over Voltage Protection
- Power Good Indicator
- Thermal Shutdown Protection
- RoHS Compliant and Halogen Free

Applications

- Industrial and Commercial Low Power Systems
- Computer Peripherals
- LCD Monitors and TVs
- Green Electronics/Appliances
- Point of Load Regulation for High-Performance DSPs, FPGAs, and ASICs

Marking Information

RT7250AZSP

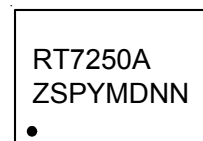

RT7250AZSP : Product Number
YMDNN : Date Code

RT7250BZSP

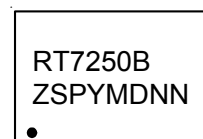

RT7250BZSP : Product Number
YMDNN : Date Code

Typical Application Circuit

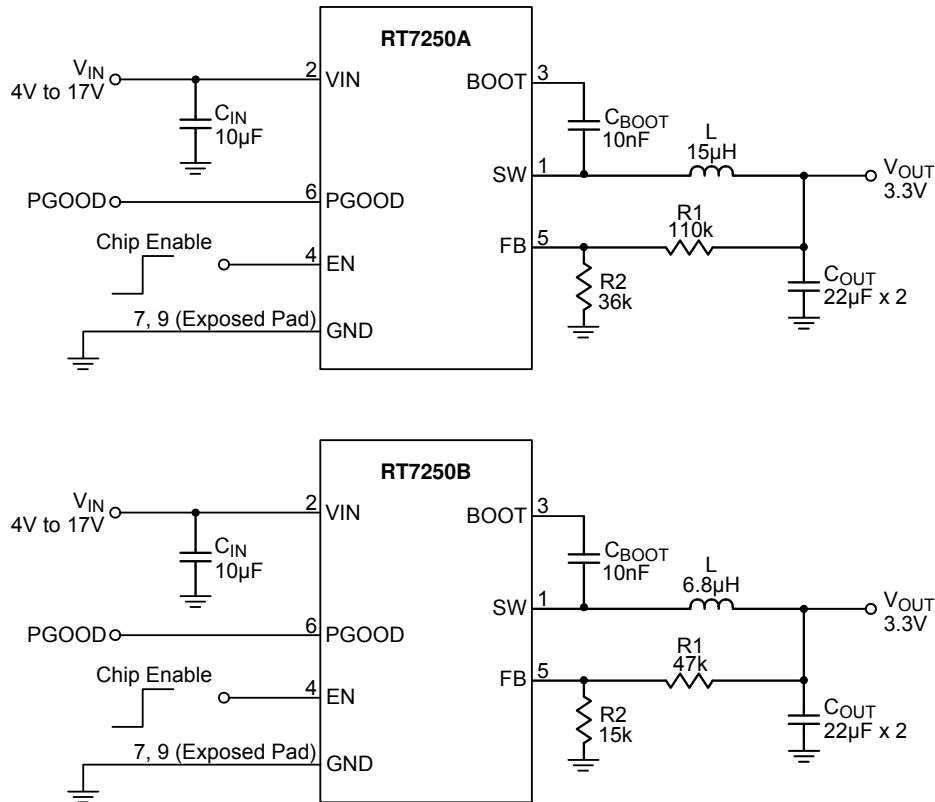

Table 1. Recommended Component Selection

RT7250A

| V _{OUT} (V) | L (µH) | R1 (kΩ) | R2 (kΩ) | C _{OUT} (µF) |
|----------------------|--------|---------|---------|-----------------------|
| 1.2 | 4.7 | 110 | 220 | 22 x 2 |
| 2.5 | 10 | 110 | 51 | 22 x 2 |
| 3.3 | 15 | 110 | 36 | 22 x 2 |
| 5 | 22 | 120 | 22 | 22 x 2 |

RT7250B

| V _{OUT} (V) | L (µH) | R1 (kΩ) | R2 (kΩ) | C _{OUT} (µF) |
|----------------------|--------|---------|---------|-----------------------|
| 1.2 | 3.6 | 47 | 91 | 22 x 2 |
| 2.5 | 4.7 | 47 | 22 | 22 x 2 |
| 3.3 | 6.8 | 47 | 15 | 22 x 2 |
| 5 | 10 | 62 | 12 | 22 x 2 |

Functional Pin Description

| Pin No. | Pin Name | Pin Function |
|-----------------------|----------|---|
| 1 | SW | Switch node. Connect to external L-C filter. |
| 2 | VIN | Input supply voltage. Must bypass with a suitably large ceramic capacitor. |
| 3 | BOOT | Bootstrap for high side gate driver. Connect 0.01 μ F or greater ceramic capacitor from BOOT to SW pin. |
| 4 | EN | Chip enable. A logic-high enables the converter; a logic-low forces the RT7250A/B into shutdown mode, reducing the supply current to less than 5 μ A. Attach this pin to VIN with a 100k Ω pull up resistor for automatic startup. |
| 5 | FB | Feedback input pin. For an adjustable output, connect an external resistive voltage divider to this pin. |
| 6 | PGOOD | Power good indicator. The output of this pin is low if the output voltage is 12.5% less than the nominal voltage. Otherwise, it is an open drain. |
| 7, 9 (Exposed Pad) | GND | Ground. The exposed pad must be soldered to a large PCB and connected to GND for maximum power dissipation. |
| 8 | NC | No internal connection. |

Functional Block Diagram

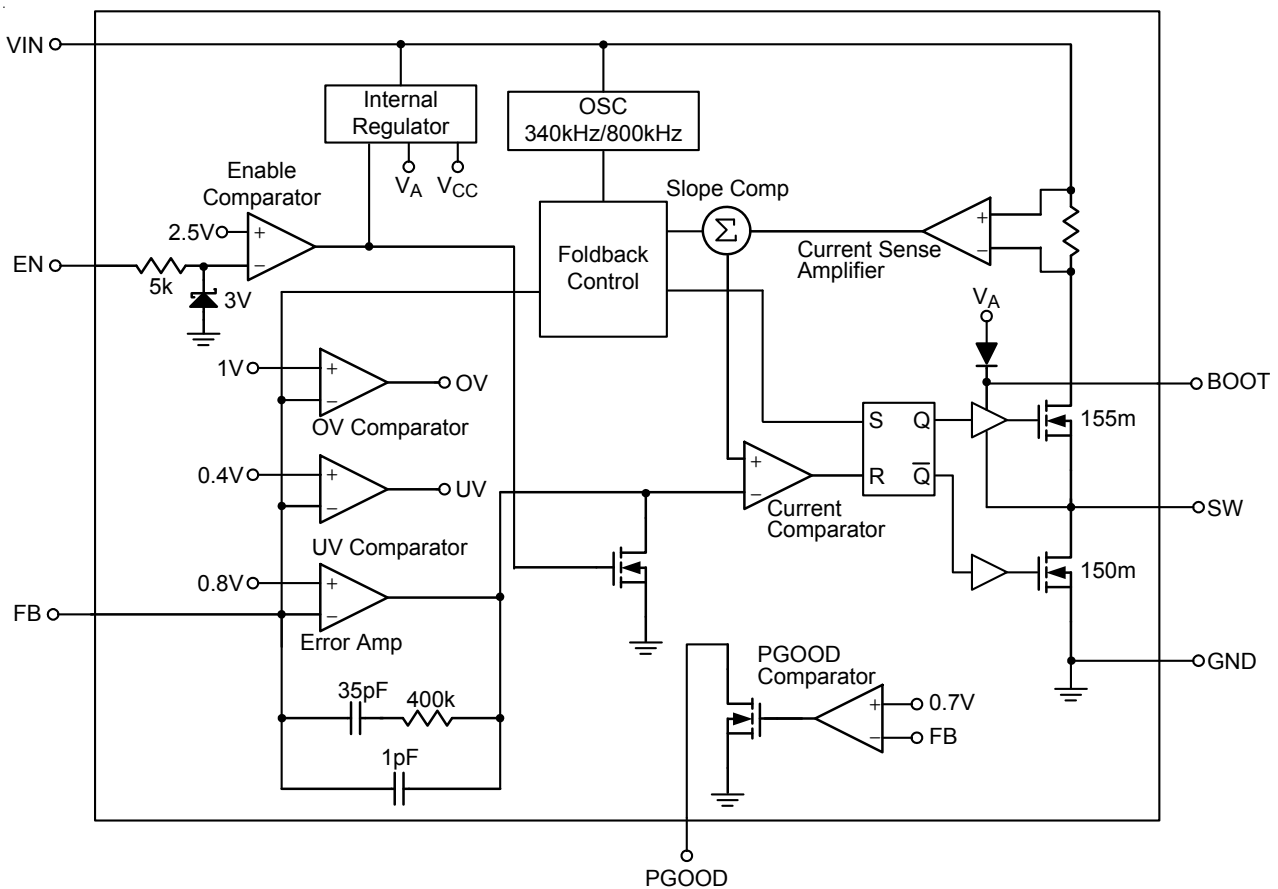

Absolute Maximum Ratings (Note 1)

| | |
|---|------------------------------|
| • Supply Voltage, V_{IN} ----- | -0.3V to 19V |
| • SW ----- | -0.3V to ($V_{IN} + 0.3V$) |
| < 10ns ----- | -5V to 25V |
| • BOOT to SW ----- | -0.3V to 6V |
| • All Other Pins ----- | -0.3V to 6V |
| • Power Dissipation, $P_D @ T_A = 25^\circ C$ | |
| SOP-8 (Exposed Pad) ----- | 1.333W |
| • Package Thermal Resistance (Note 2) | |
| SOP-8 (Exposed Pad), θ_{JA} ----- | 75°C/W |
| SOP-8 (Exposed Pad), θ_{JC} ----- | 15°C/W |
| • Lead Temperature (Soldering, 10 sec.) ----- | 260°C |
| • Junction Temperature ----- | 150°C |
| • Storage Temperature Range ----- | -65°C to 150°C |
| • ESD Susceptibility (Note 3) | |
| HBM (Human Body Model) ----- | 2kV |
| MM (Machine Model) ----- | 200V |

Recommended Operating Conditions (Note 4)

| | |
|--|----------------|
| • Supply Input Voltage, V_{IN} ----- | 4V to 17V |
| • Junction Temperature Range ----- | -40°C to 125°C |
| • Ambient Temperature Range ----- | -40°C to 85°C |

Electrical Characteristics

($V_{IN} = 12V$, $T_A = 25^\circ C$, unless otherwise specified)

| Parameter | Symbol | Test Conditions | Min | Typ | Max | Unit |
|-------------------------------------|------------------|---|-------|-----|-------|------------|
| Shutdown Supply Current | ISHDN | $V_{EN} = 0V$ | -- | 1 | 5 | μA |
| Supply Current | I _{OUT} | $V_{EN} = 3V$, $V_{FB} = 0.9V$ | -- | 0.6 | 1 | mA |
| Feedback Reference Voltage | V_{FB} | $4V \leq V_{IN} \leq 17V$ | 0.788 | 0.8 | 0.812 | V |
| Feedback Current | I _{FB} | $V_{FB} = 0.8V$ | -- | 10 | -- | nA |
| High Side Switch On Resistance | $R_{DS(ON)1}$ | | -- | 155 | -- | m Ω |
| Low Side Switch On Resistance | $R_{DS(ON)2}$ | | -- | 150 | -- | m Ω |
| Upper Switch Current Limit | | Min. duty cycle, $V_{BOOT} - V_{SW} = 4.8V$ maximum loading = 2A | -- | 3.6 | -- | A |
| Lower Switch Current Limit | | From drain to source | -- | 1 | -- | A |
| Oscillation Frequency | f_{OSC1} | For RT7250A | 300 | 340 | 380 | kHz |
| | | For RT7250B | 700 | 800 | 900 | |
| Short-Circuit Oscillation Frequency | f_{OSC2} | $V_{FB} = 0V$, For RT7250A | -- | 95 | -- | kHz |
| | | $V_{FB} = 0V$, For RT7250B | -- | 170 | -- | |
| Maximum Duty Cycle | D_{MAX} | $V_{FB} = 0.7V$, For RT7250A | -- | 93 | -- | % |
| | | $V_{FB} = 0.7V$, For RT7250B | -- | 84 | -- | |

| Parameter | Symbol | Test Conditions | Min | Typ | Max | Unit |
|--|--------------------|--|-----|-----|-----|-------------------|
| Minimum On Time | t _{ON} | | -- | 100 | -- | ns |
| Input Under Voltage Lockout Threshold | V _{UVLO} | | -- | 3.5 | -- | V |
| Input Under Voltage Lockout Threshold Hysteresis | ΔV _{UVLO} | | -- | 200 | -- | mV |
| EN Threshold Voltage | Logic-High | V _{IH} | 2.7 | -- | -- | V |
| | Logic-Low | V _{IL} | -- | -- | 0.4 | |
| EN Pull Low Current | | V _{EN} = 2V, V _{FB} = 1V | -- | 1 | -- | μA |
| Soft-Start Period | t _{SS} | | -- | 1 | -- | ms |
| Thermal Shutdown | T _{SD} | | -- | 150 | -- | °C |
| Thermal Shutdown Hysteresis | ΔT _{SD} | | -- | 15 | -- | °C |
| Power Good Threshold Rising | | | -- | 0.7 | -- | V |
| Power Good Threshold Hysteresis | | | -- | 130 | -- | mV |
| Power Good Pull Down Resistance | | | -- | 12 | -- | Ω |
| Output OVP Threshold | | | -- | 125 | -- | %V _{REF} |
| Output OVP Propagation Delay | | | -- | 10 | -- | μs |

Note 1. Stresses beyond those listed under “Absolute Maximum Ratings” may cause permanent damage to the device. These are stress ratings only, and functional operation of the device at these or any other conditions beyond those indicated in the operational sections of the specifications is not implied. Exposure to absolute maximum rating conditions may affect device reliability.

Note 2. θ_{JA} is measured at T_A = 25°C on a high effective thermal conductivity four-layer test board per JEDEC 51-7. θ_{JC} is measured at the exposed pad of the package.

Note 3. Devices are ESD sensitive. Handling precaution is recommended.

Note 4. The device is not guaranteed to function outside its operating conditions.

Typical Operating Characteristics

Efficiency vs. Output Current

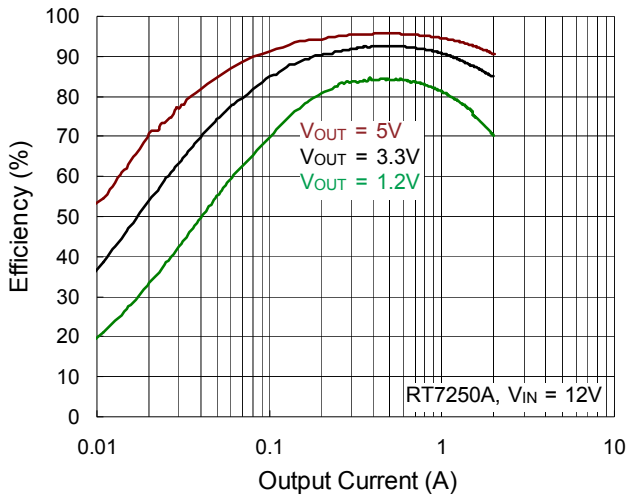

Efficiency vs. Output Current

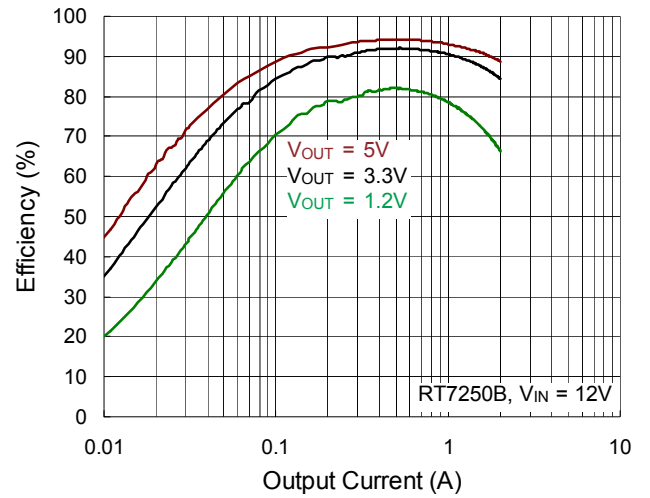

Output Voltage vs. Output Current

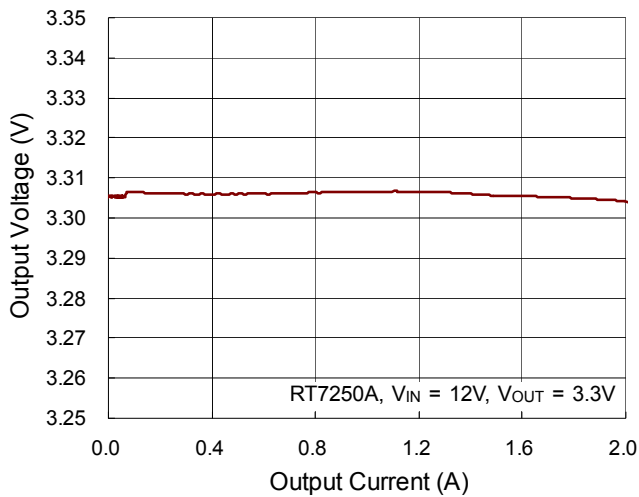

Output Voltage vs. Output Current

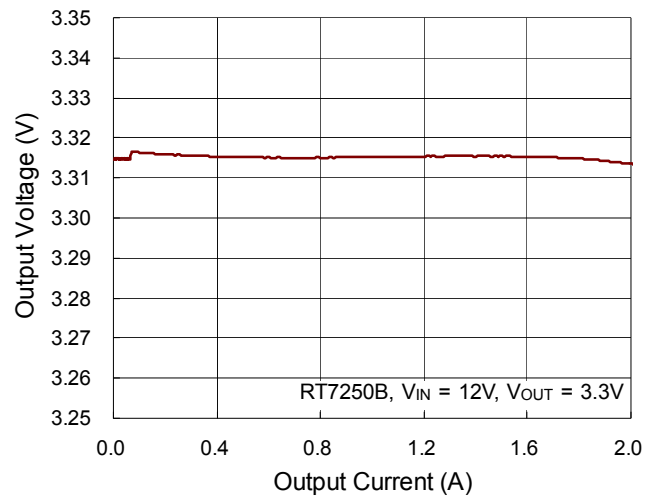

Reference Voltage vs. Temperature

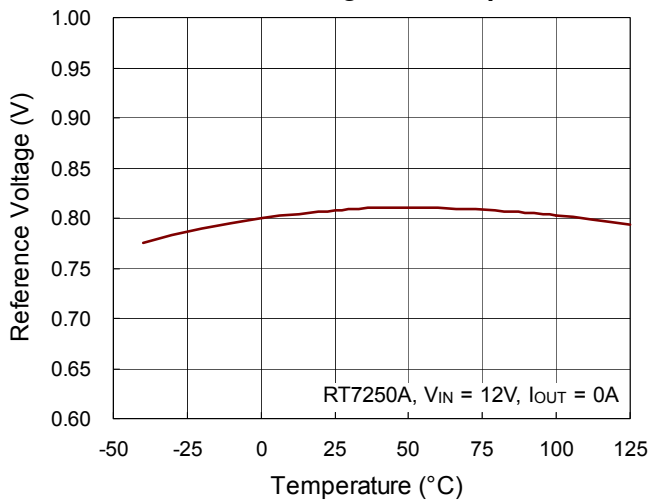

Reference Voltage vs. Temperature

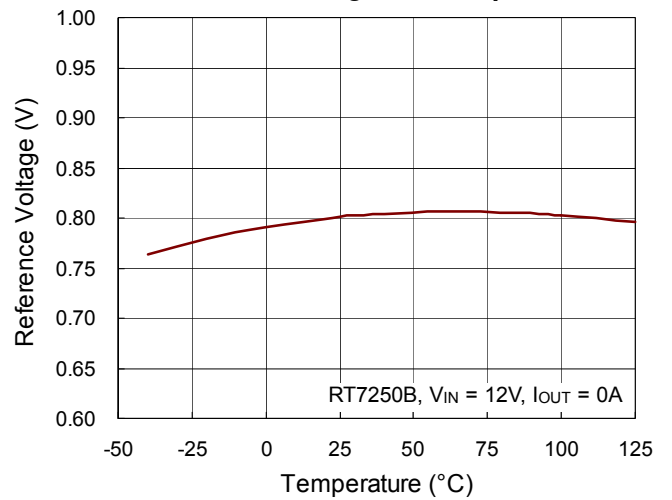

Frequency vs. Input Voltage

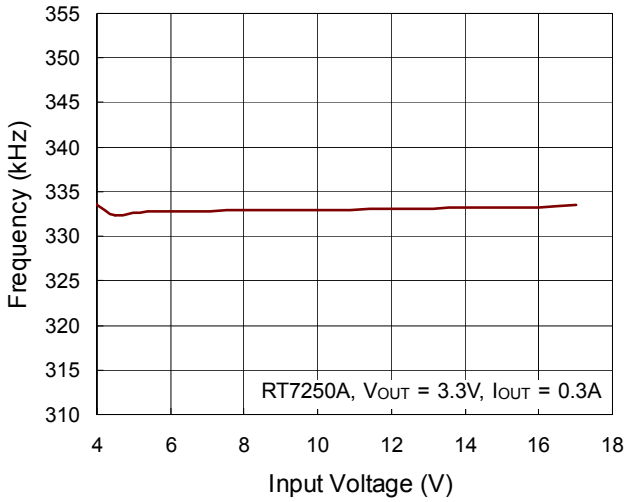

Frequency vs. Input Voltage

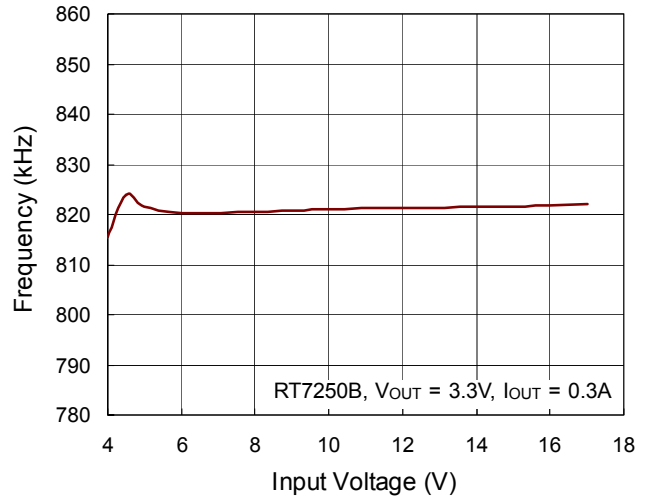

Frequency vs. Temperature

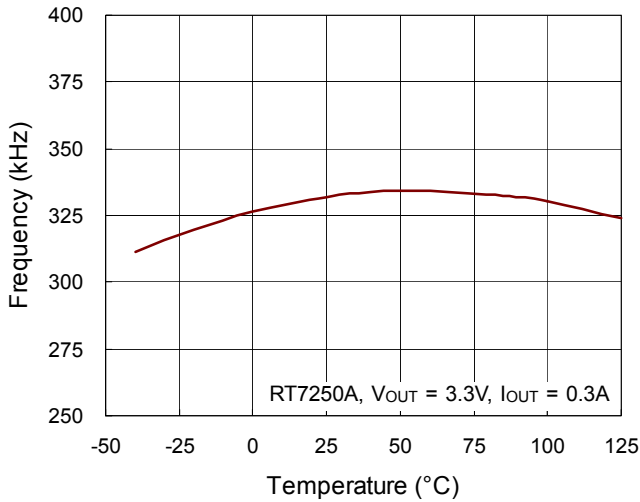

Frequency vs. Temperature

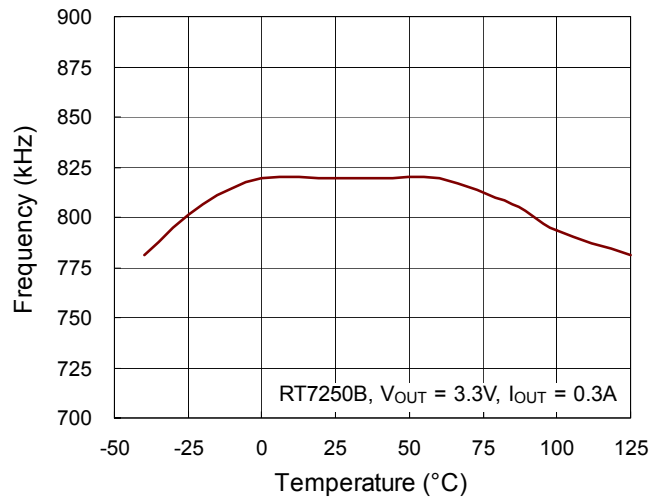

Quiescent Current vs. Input Voltage

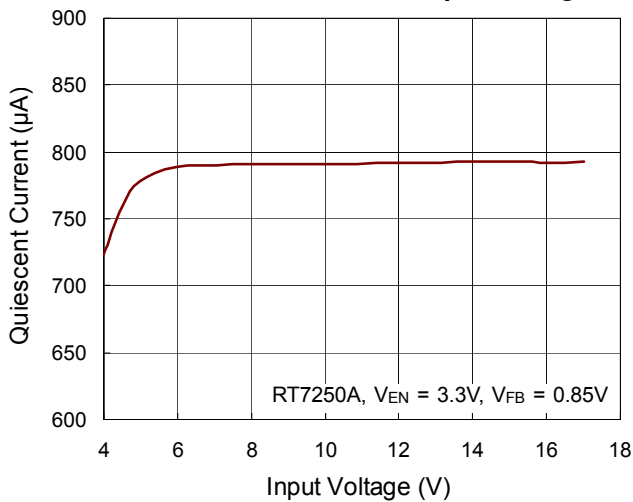

Quiescent Current vs. Input Voltage

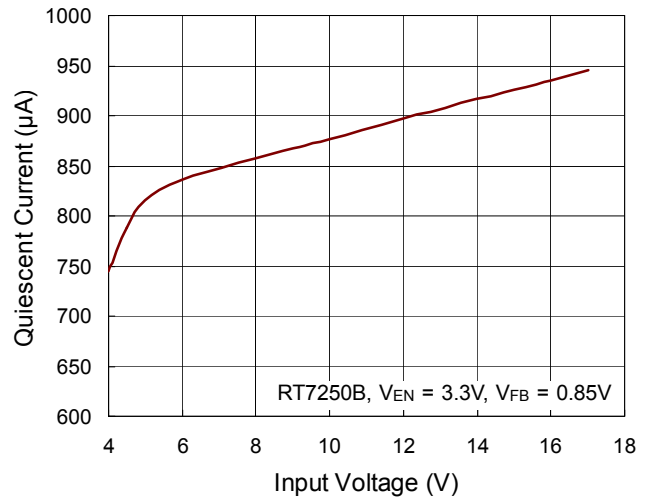

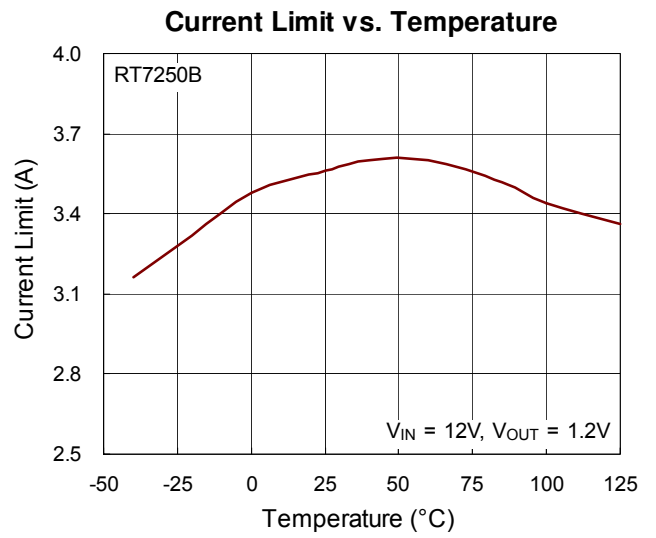
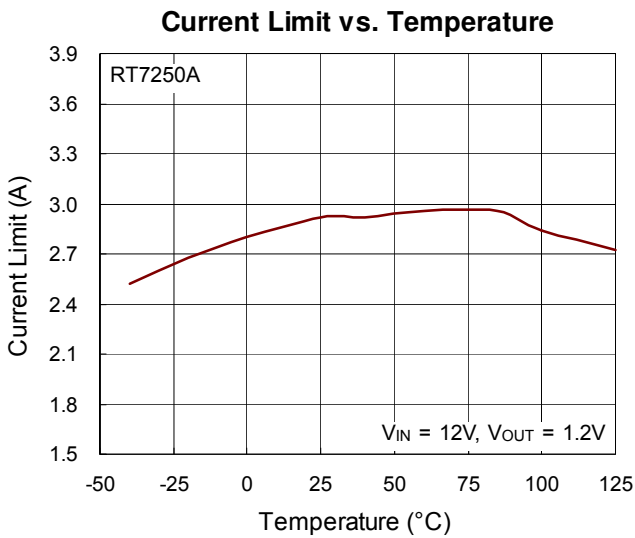
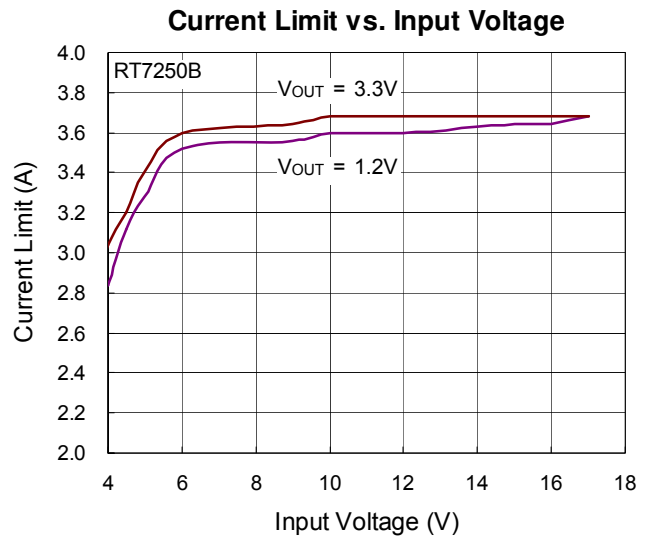
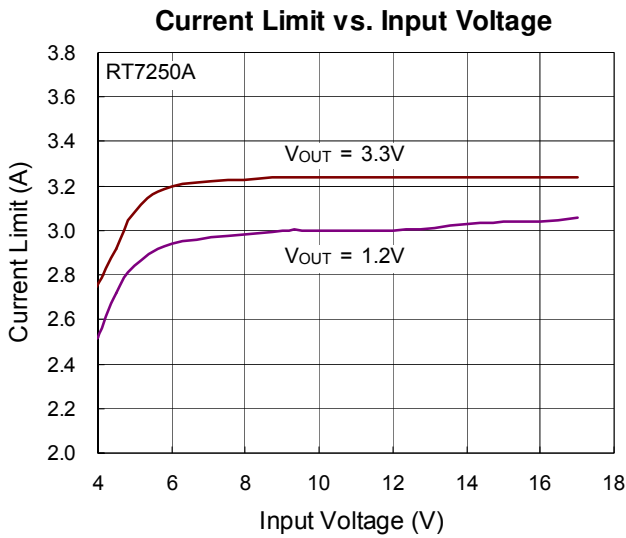
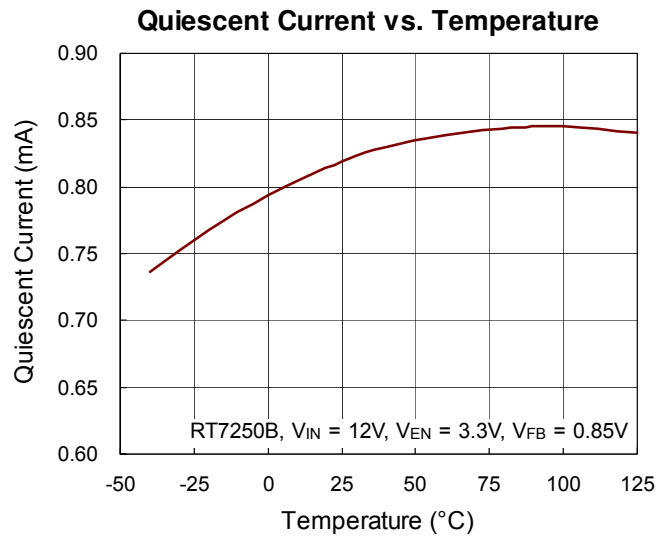
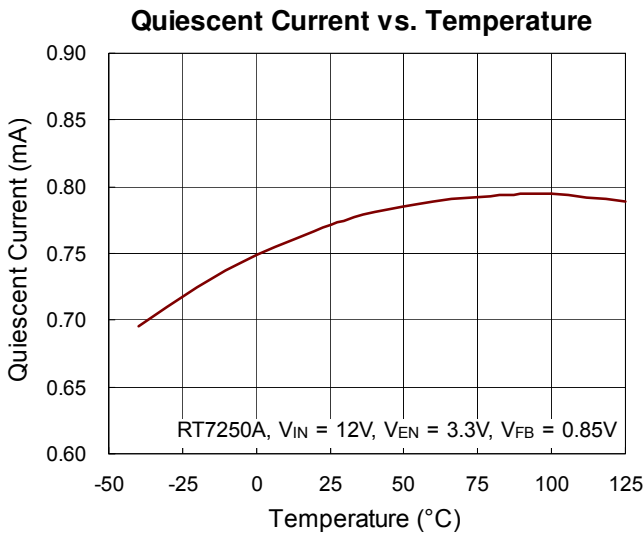

Load Transient Response

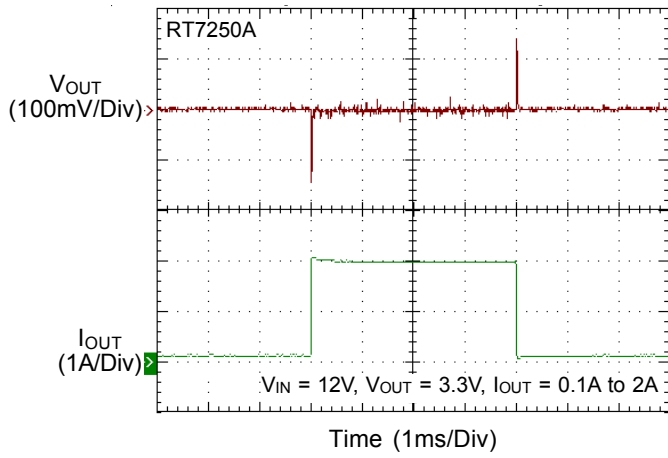

Load Transient Response

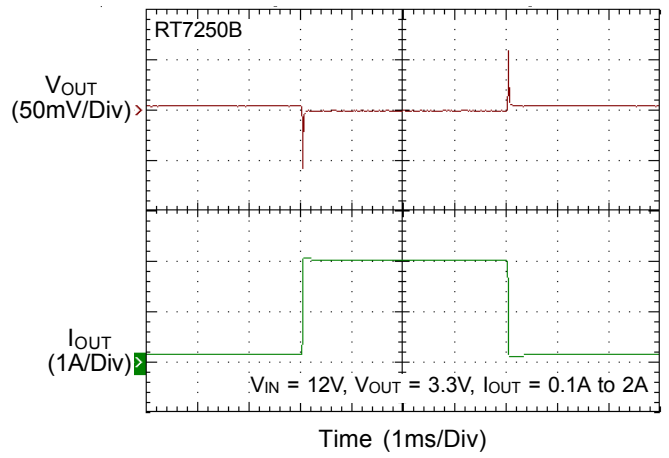

Switching

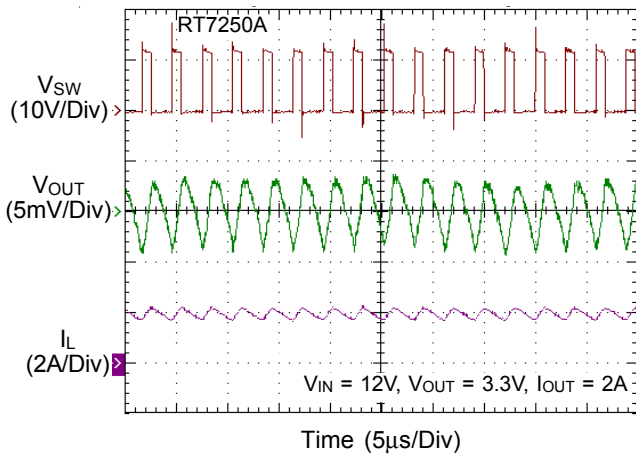

Switching

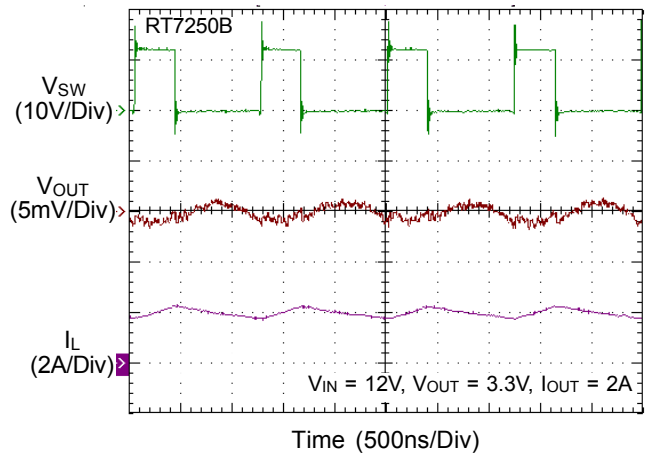

Power On from EN

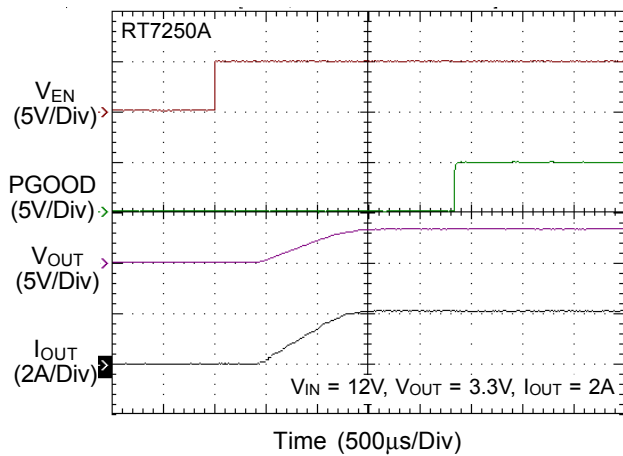

Power On from EN

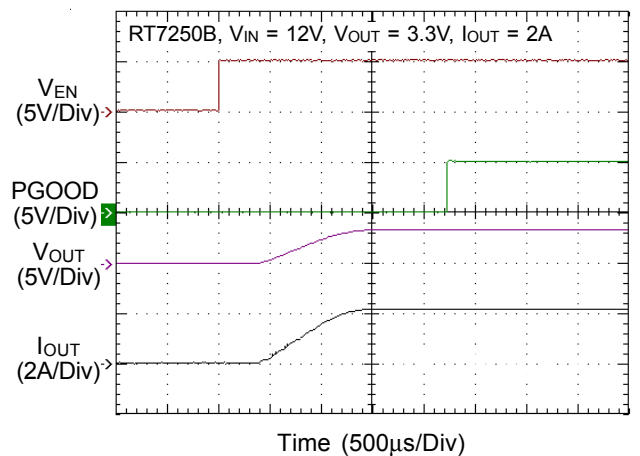

Power Off from EN

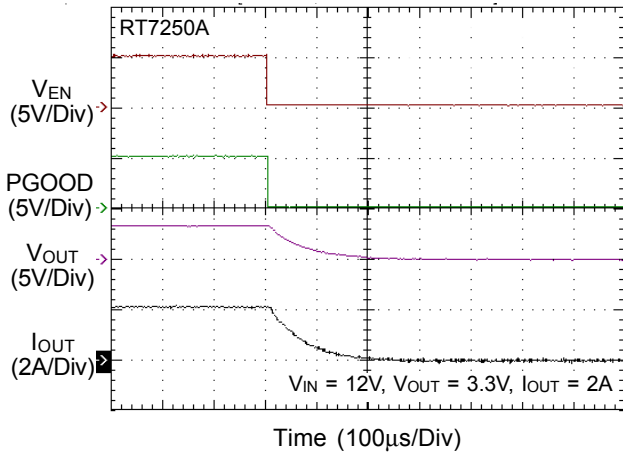

Power Off from EN

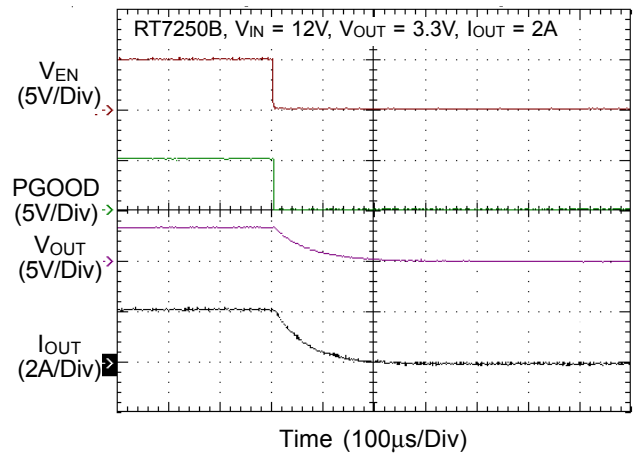

Application Information

The RT7250A/B is a synchronous high voltage buck converter that can support the input voltage range from 4V to 17V and the output current can be up to 2A.

Output Voltage Setting

The resistive divider allows the FB pin to sense the output voltage as shown in Figure 1.

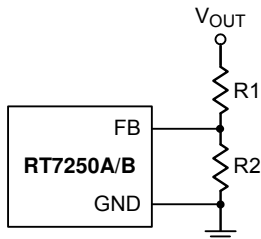

Figure 1. Output Voltage Setting

The output voltage is set by an external resistive divider according to the following equation :

$$V_{OUT} = V_{FB} \left(1 + \frac{R1}{R2} \right)$$

Where V_{FB} is the feedback reference voltage (0.8V typ.).

External Bootstrap Diode

Connect a 10nF low ESR ceramic capacitor between the BOOT pin and SW pin. This capacitor provides the gate driver voltage for the high side MOSFET. It is recommended to add an external bootstrap diode between an external 5V and the BOOT pin for efficiency improvement when input voltage is lower than 5.5V or duty ratio is higher than 65%. The bootstrap diode can be a low cost one such as 1N4148 or BAT54. The external 5V can be a 5V fixed input from system or a 5V output of the RT7250A/B. Note that the external boot voltage must be lower than 5.5V

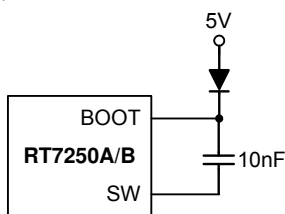

Figure 2. External Bootstrap Diode

Over Voltage Protection (OVP)

The RT7250A/B provides Over Voltage Protection function when output voltage over 125%. The internal MOS will be turned off. The control will return to normal operation if over voltage condition is removed.

Under Voltage Protection (UVP)

For the RT7250A/B, it provides Hiccup Mode Under Voltage Protection (UVP). When the FB voltage drops below 50% of the feedback reference voltage, the UVP function will be triggered and the RT7250A/B will shut down for a period of time and then recover automatically. The Hiccup Mode UVP can reduce input current in short-circuit conditions.

Inductor Selection

The inductor value and operating frequency determine the ripple current according to a specific input and output voltage. The ripple current ΔI_L increases with higher V_{IN} and decreases with higher inductance.

$$\Delta I_L = \left[\frac{V_{OUT}}{f \times L} \right] \left[1 - \frac{V_{OUT}}{V_{IN}} \right]$$

Having a lower ripple current reduces not only the ESR losses in the output capacitors but also the output voltage ripple. High frequency with small ripple current can achieve highest efficiency operation. However, it requires a large inductor to achieve this goal. For the ripple current selection, the value of $\Delta I_L = 0.2(I_{MAX})$ will be a reasonable starting point. The largest ripple current occurs at the highest V_{IN} . To guarantee that the ripple current stays below the specified maximum, the inductor value should be chosen according to the following equation :

$$L = \left[\frac{V_{OUT}}{f \times \Delta I_L(MAX)} \right] \left[1 - \frac{V_{OUT}}{V_{IN(MAX)}} \right]$$

Table 2. Suggested Inductors for Typical Application Circuit

| Component Supplier | Series | Dimensions (mm) |
|--------------------|----------|-------------------|
| TDK | VLF10045 | 10 x 9.7 x 4.5 |
| TDK | SLF12565 | 12.5 x 12.5 x 6.5 |
| TAIYO YUDEN | NR8040 | 8 x 8 x 4 |

C_{IN} and C_{OUT} Selection

The input capacitance, C_{IN}, is needed to filter the trapezoidal current at the source of the high side MOSFET. To prevent large ripple current, a low ESR input capacitor sized for the maximum RMS current should be used. The RMS current is given by :

$$I_{RMS} = I_{OUT(MAX)} \frac{V_{OUT}}{V_{IN}} \sqrt{\frac{V_{IN}}{V_{OUT}} - 1}$$

This formula has a maximum at V_{IN} = 2V_{OUT}, where I_{RMS} = I_{OUT}/2. This simple worst-case condition is commonly used for design because even significant deviations do not offer much relief. Choose a capacitor rated at a higher temperature than required. Several capacitors may also be paralleled to meet size or height requirements in the design. For the input capacitor, a 10μF low ESR ceramic capacitor is recommended. For the recommended capacitor, please refer to table 3 for more detail. The selection of C_{OUT} is determined by the required ESR to minimize voltage ripple. Moreover, the amount of bulk capacitance is also a key for C_{OUT} selection to ensure that the control loop is stable. Loop stability can be checked by viewing the load transient response as described in a later section. The output ripple, ΔV_{OUT}, is determined by :

$$\Delta V_{OUT} \leq \Delta I_L \left[ESR + \frac{1}{8fC_{OUT}} \right]$$

The output ripple will be highest at the maximum input voltage since ΔI_L increases with input voltage. Multiple capacitors placed in parallel may be needed to meet the

ESR and RMS current handling requirement. Dry tantalum, special polymer, aluminum electrolytic and ceramic capacitors are all available in surface mount packages. Special polymer capacitors offer very low ESR value. However, it provides lower capacitance density than other types. Although Tantalum capacitors have the highest capacitance density, it is important to only use types that pass the surge test for use in switching power supplies. Aluminum electrolytic capacitors have significantly higher ESR. However, it can be used in cost-sensitive applications for ripple current rating and long term reliability considerations. Ceramic capacitors have excellent low ESR characteristics but can have a high voltage coefficient and audible piezoelectric effects. The high Q of ceramic capacitors with trace inductance can also lead to significant ringing.

Higher values, lower cost ceramic capacitors are now becoming available in smaller case sizes. Their high ripple current, high voltage rating and low ESR make them ideal for switching regulator applications. However, care must be taken when these capacitors are used at input and output. When a ceramic capacitor is used at the input and the power is supplied by a wall adapter through long wires, a load step at the output can induce ringing at the input, V_{IN}. At best, this ringing can couple to the output and be mistaken as loop instability. At worst, a sudden inrush of current through the long wires can potentially cause a voltage spike at V_{IN} large enough to damage the part.

Table 3. Suggested Capacitors for C_{IN} and C_{OUT}

| Component Supplier | Part No. | Capacitance (μF) | Case Size |
|--------------------|----------------|------------------|-----------|
| MURATA | GRM31CR61E106K | 10 | 1206 |
| TDK | C3225X5R1E106K | 10 | 1206 |
| TAIYO YUDEN | TMK316BJ106ML | 10 | 1206 |
| MURATA | GRM31CR60J476M | 47 | 1206 |
| TDK | C3225X5R0J476M | 47 | 1210 |
| TAIYO YUDEN | EMK325BJ476MM | 47 | 1210 |
| MURATA | GRM32ER71C226M | 22 | 1210 |
| TDK | C3225X5R1C226M | 22 | 1210 |

Checking Transient Response

The regulator loop response can be checked by looking at the load transient response. Switching regulators take several cycles to respond to a step in load current. When a load step occurs, V_{OUT} immediately shifts by an amount equal to $\Delta I_{LOAD} (ESR)$ also begins to charge or discharge C_{OUT} generating a feedback error signal for the regulator to return V_{OUT} to its steady-state value. During this recovery time, V_{OUT} can be monitored for overshoot or ringing that would indicate a stability problem.

Thermal Considerations

For continuous operation, do not exceed the maximum operation junction temperature 125°C. The maximum power dissipation depends on the thermal resistance of IC package, PCB layout, the rate of surroundings airflow and temperature difference between junction to ambient. The maximum power dissipation can be calculated by following formula :

$$P_{D(MAX)} = (T_{J(MAX)} - T_A) / \theta_{JA}$$

Where $T_{J(MAX)}$ is the maximum operation junction temperature, T_A is the ambient temperature and the θ_{JA} is the junction to ambient thermal resistance.

For recommended operating condition specifications, the maximum junction temperature is 125°C. The junction to ambient thermal resistance, θ_{JA} , is layout dependent. For SOP-8 (Exposed Pad) packages, the thermal resistance, θ_{JA} , is 75°C/W on a standard JEDEC 51-7 four-layer thermal test board. The maximum power dissipation at $T_A = 25^\circ\text{C}$ can be calculated by the following formula :

$$P_{D(MAX)} = (125^\circ\text{C} - 25^\circ\text{C}) / (75^\circ\text{C/W}) = 1.333\text{W for SOP-8 (Exposed Pad) package}$$

The maximum power dissipation depends on the operating ambient temperature for fixed $T_{J(MAX)}$ and thermal resistance, θ_{JA} . The derating curve in Figure 3 allows the designer to see the effect of rising ambient temperature on the maximum power dissipation.

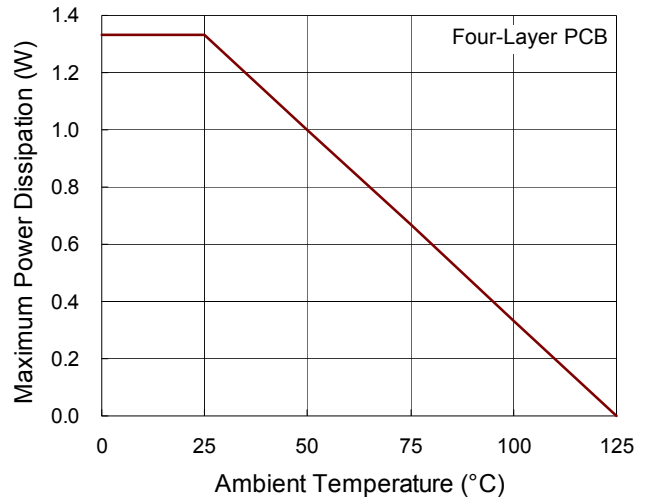

Figure 3. Derating Curve of Maximum Power Dissipation

Layout Consideration

Follow the PCB layout guidelines for optimal performance of the RT7250A/B

- ▶ Keep the traces of the main current paths as short and wide as possible.
- ▶ Put the input capacitor as close as possible to the device pins (V_{IN} and GND).
- ▶ SW node is with high frequency voltage swing and should be kept at small area. Keep sensitive components away from the SW node to prevent stray capacitive noise pickup.
- ▶ Place the feedback components to the FB pin as close as possible.
- ▶ The GND and Exposed Pad should be connected to a strong ground plane for heat sinking and noise protection.

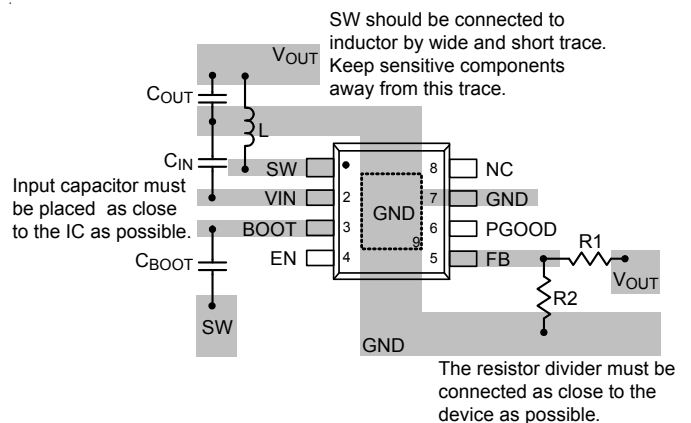
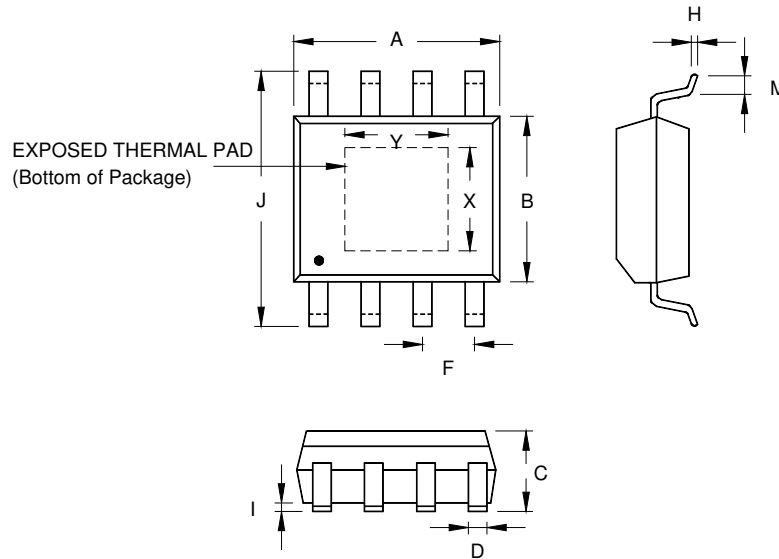

Figure 4. PCB Layout Guide

Outline Dimension



| Symbol | Dimensions In Millimeters | | Dimensions In Inches | | |
|----------|---------------------------|-------|----------------------|-------|-------|
| | Min | Max | Min | Max | |
| A | 4.801 | 5.004 | 0.189 | 0.197 | |
| B | 3.810 | 4.000 | 0.150 | 0.157 | |
| C | 1.346 | 1.753 | 0.053 | 0.069 | |
| D | 0.330 | 0.510 | 0.013 | 0.020 | |
| F | 1.194 | 1.346 | 0.047 | 0.053 | |
| H | 0.170 | 0.254 | 0.007 | 0.010 | |
| I | 0.000 | 0.152 | 0.000 | 0.006 | |
| J | 5.791 | 6.200 | 0.228 | 0.244 | |
| M | 0.406 | 1.270 | 0.016 | 0.050 | |
| Option 1 | X | 2.000 | 2.300 | 0.079 | 0.091 |
| | Y | 2.000 | 2.300 | 0.079 | 0.091 |
| Option 2 | X | 2.100 | 2.500 | 0.083 | 0.098 |
| | Y | 3.000 | 3.500 | 0.118 | 0.138 |

8-Lead SOP (Exposed Pad) Plastic Package

Richtek Technology Corporation

14F, No. 8, Tai Yuen 1st Street, Chupei City
 Hsinchu, Taiwan, R.O.C.
 Tel: (8863)5526789

Richtek products are sold by description only. Customers should obtain the latest relevant information and data sheets before placing orders and should verify that such information is current and complete. Richtek cannot assume responsibility for use of any circuitry other than circuitry entirely embodied in a Richtek product. Information furnished by Richtek is believed to be accurate and reliable. However, no responsibility is assumed by Richtek or its subsidiaries for its use; nor for any infringements of patents or other rights of third parties which may result from its use. No license is granted by implication or otherwise under any patent or patent rights of Richtek or its subsidiaries.