

General information

Part number	G53LOC-P10LPNO-0000
Termination	solder
Size	3
Locking principle	break , push
Coding	0_key

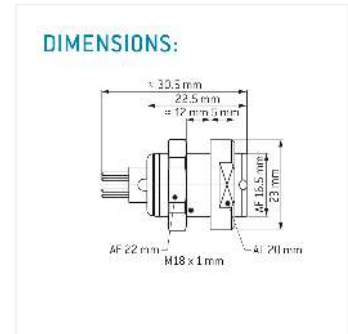
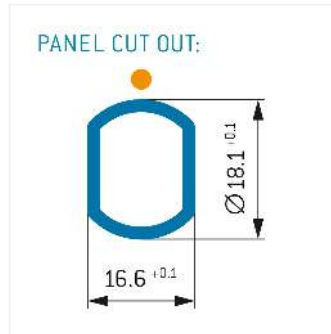
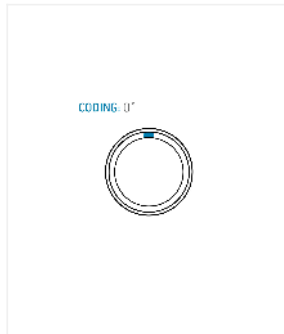

Contact insert description

Number of contacts	10
Contact type	sockets
Contact diameter	13mm
Insulator material	peek
Wire cross section	18_awg
Termination	solder
Termination diameter	14mm

reverse_gender_on_request

Technical information

Max. creepage and air clearance distance	09_mm	11_mm
Nominal current single contact	15_a	iec_60512_5_2
Nominal current insert	8,25 A	vde_0298_4
Test voltage	11_kv_ac	sae_13441

safety_text

Mechanical and environmental data

Degree of protection*	ip50
Operating temperature	40_120_c
Mating cycles	5000

mated_unmated

Material and surface treatments

Housing	m_chrome
Contact	cu_alloy_gold

safety_text_2
ul_text
illustrative_text