



# CAT5401

## Quad Digitally Programmable Potentiometers (DPP™) with 64 Taps and SPI Interface

### FEATURES

- Four linear-taper digitally programmable potentiometers
- 64 resistor taps per potentiometer
- End to end resistance 2.5kΩ, 10kΩ, 50kΩ or 100kΩ
- Potentiometer control and memory access via SPI interface: Mode (0, 0) and (1, 1)
- Low wiper resistance, typically 80Ω
- Nonvolatile memory storage for up to four wiper settings for each potentiometer
- Automatic recall of saved wiper settings at power up
- 2.5 to 6.0 volt operation
- Standby current less than 1μA
- 1,000,000 nonvolatile WRITE cycles
- 100 year nonvolatile memory data retention
- 24-lead SOIC, 24-lead TSSOP and BGA
- Industrial temperature range

### DESCRIPTION

The CAT5401 is four Digitally Programmable Potentiometers (DPPs™) integrated with control logic and 16 bytes of NVRAM memory. Each DPP consists of a series of 63 resistive elements connected between two externally accessible end points. The tap points between each resistive element are connected to the wiper outputs with CMOS switches. A separate 6-bit control register (WCR) independently controls the wiper tap switches for each DPP. Associated with each wiper control register are four 6-bit non-volatile memory data registers (DR) used for storing up to four wiper settings. Writing to the

wiper control register or any of the non-volatile data registers is via a SPI serial bus. On power-up, the contents of the first data register (DR0) for each of the four potentiometers is automatically loaded into its respective wiper control register.

The CAT5401 can be used as a potentiometer or as a two terminal, variable resistor. It is intended for circuit level or system level adjustments in a wide variety of applications.

### PIN CONFIGURATION

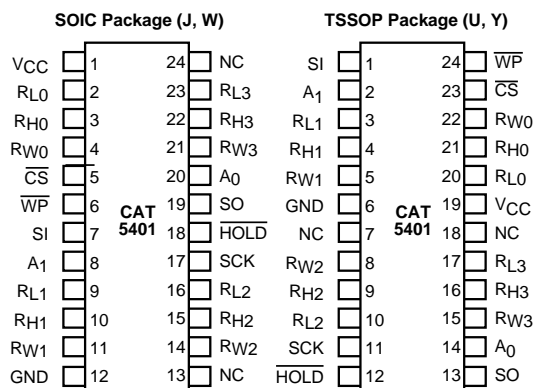

### FUNCTIONAL DIAGRAM

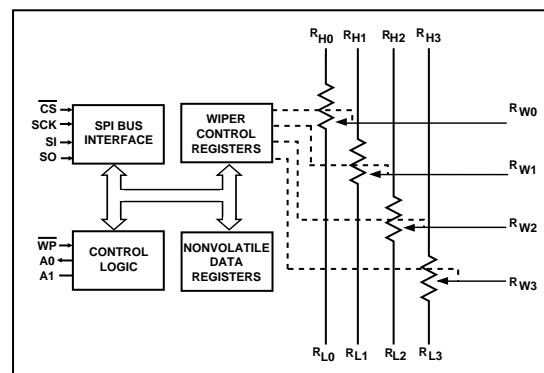

Top View - Bump Side Down

## PIN DESCRIPTION

Pin (SOIC)	Pin (TSSOP)	Pin (BGA)	Name	Function
1	19	C1	VCC	Supply Voltage
2	20	B1	R <sub>L0</sub>	Low Reference Terminal for Potentiometer 0
3	21	C2	R <sub>H0</sub>	High Reference Terminal for Potentiometer 0
4	22	A1	R <sub>W0</sub>	Wiper Terminal for Potentiometer 0
5	23	A2	$\overline{CS}$	Chip Select
6	24	B2	$\overline{WP}$	Write Protection
7	1	B3	SI	Serial Input
8	2	A3	A1	Device Address
9	3	A4	R <sub>L1</sub>	Low Reference Terminal for Potentiometer 1
10	4	C3	R <sub>H1</sub>	High Reference Terminal for Potentiometer 1
11	5	B4	R <sub>W1</sub>	Wiper Terminal for Potentiometer 1
12	6	C4	GND	Ground
13	7	D4	NC	No Connect
14	8	E4	R <sub>W2</sub>	Wiper Terminal for Potentiometer 2
15	9	D3	R <sub>H2</sub>	High Reference Terminal for Potentiometer 2
16	10	F4	R <sub>L2</sub>	Low Reference Terminal for Potentiometer 2
17	11	F3	SCK	Bus Serial Clock
18	12	E3	$\overline{HOLD}$	Hold
19	13	E2	SO	Serial Data Output
20	14	F2	A0	Device Address, LSB
21	15	F1	R <sub>W3</sub>	Wiper Terminal for Potentiometer 3
22	16	D2	R <sub>H3</sub>	High Reference Terminal for Potentiometer 3
23	17	E1	R <sub>L3</sub>	Low Reference Terminal for Potentiometer 3
24	18	D1	NC	No Connect

**WP: Write Protect**

$\overline{WP}$  is the Write Protect pin. The Write Protect pin will allow normal read/write operations when held high. When  $\overline{WP}$  is tied low, all non-volatile write operations to the Data registers are inhibited (change of wiper control register is allowed).  $\overline{WP}$  going low while CS is still low will interrupt a write to the registers. If the internal write cycle has already been initiated,  $\overline{WP}$  going low will have no effect on any write operation.

**HOLD: Hold**

The HOLD pin is used to pause transmission to the CAT5401 while in the middle of a serial sequence without having to re-transmit entire sequence at a later time. To pause,  $\overline{HOLD}$  must be brought low while SCK is low. The SO pin is in a high impedance state during the time the part is paused, and transitions on the SI pins will be ignored. To resume communication,  $\overline{HOLD}$  is brought high, while SCK is low. ( $\overline{HOLD}$  should be held high any time this function is not being used.)  $\overline{HOLD}$  may be tied high directly to VCC or tied to VCC through a resistor.

## PIN DESCRIPTIONS

**SI: Serial Input**

SI is the serial data input pin. This pin is used to input all opcodes, byte addresses and data to be written to the CAT5401. Input data is latched on the rising edge of the serial clock.

**SO: Serial Output**

SO is the serial data output pin. This pin is used to transfer data out of the CAT5401. During a read cycle, data is shifted out on the falling edge of the serial clock.

**SCK: Serial Clock**

SCK is the serial clock pin. This pin is used to synchronize the communication between the microcontroller and the CAT5401. Opcodes, byte addresses or data present on the SI pin are latched on the rising edge of the SCK. Data on the SO pin is updated on the falling edge of the SCK.

**A0, A1: Device Address Inputs**

These inputs set the device address when addressing multiple devices. A total of four devices can be addressed on a single bus. A match in the slave address must be made with the address input in order to initiate communication with the CAT5401.

**R<sub>H</sub>, R<sub>L</sub>: Resistor End Points**

The four sets of R<sub>H</sub> and R<sub>L</sub> pins are equivalent to the terminal connections on a mechanical potentiometer.

**R<sub>w</sub>: Wiper**

The four R<sub>w</sub> pins are equivalent to the wiper terminal of a mechanical potentiometer.

 **$\overline{CS}$ : Chip Select**

$\overline{CS}$  is the Chip select pin.  $\overline{CS}$  low enables the CAT5401 and  $\overline{CS}$  high disables the CAT5401.  $\overline{CS}$  high takes the SO output pin to high impedance and forces the devices into a Standby mode (unless an internal write operation is underway). The CAT5401 draws ZERO current in the Standby mode. A high to low transition on  $\overline{CS}$  is required prior to any sequence being initiated. A low to high transition on  $\overline{CS}$  after a valid write sequence is what initiates an internal write cycle.

## SERIAL BUS PROTOCOL

The CAT5401 supports the SPI bus data transmission protocol. The synchronous Serial Peripheral Interface (SPI) helps the CAT5401 to interface directly with many of today's popular microcontrollers. The CAT5401 contains an 8-bit instruction register. The instruction set and the operation codes are detailed in the instruction set table 3.

## DEVICE OPERATION

The CAT5401 is four resistor arrays integrated with SPI serial interface logic, four 6-bit wiper control registers and sixteen 6-bit, non-volatile memory data registers. Each resistor array contains 63 separate resistive elements connected in series. The physical ends of each array are equivalent to the fixed terminals of a mechanical potentiometer ( $R_H$  and  $R_L$ ).  $R_H$  and  $R_L$  are symmetrical and may be interchanged. The tap positions between and at the ends of the series resistors are connected to the output wiper terminals ( $R_W$ ) by a

CMOS transistor switch. Only one tap point for each potentiometer is connected to its wiper terminal at a time and is determined by the value of the wiper control register. Data can be read or written to the wiper control registers or the non-volatile memory data registers via the SPI bus. Additional instructions allows data to be transferred between the wiper control registers and each respective potentiometer's non-volatile data registers. Also, the device can be instructed to operate in an "increment/decrement" mode.

**ABSOLUTE MAXIMUM RATINGS\***

Temperature Under Bias ..... -55°C to +125°C  
 Storage Temperature ..... -65°C to +150°C  
 Voltage on any Pin with  
     Respect to V<sub>SS</sub><sup>(1)</sup> ..... -2.0V to +V<sub>CC</sub> +2.0V  
 V<sub>CC</sub> with Respect to Ground ..... -2.0V to +7.0V  
 Package Power Dissipation  
     Capability (T<sub>A</sub> = 25°C) ..... 1.0W  
 Lead Soldering Temperature (10 secs) ..... 300°C  
 Wiper Current ..... ±12mA

**\*COMMENT**

Stresses above those listed under "Absolute Maximum Ratings" may cause permanent damage to the device. These are stress ratings only, and functional operation of the device at these or any other conditions outside of those listed in the operational sections of this specification is not implied. Exposure to any absolute maximum rating for extended periods may affect device performance and reliability.

<b>Recommended Operating Conditions:</b>		
V <sub>CC</sub> = +2.5V to +6.0V		
<b>Temperature</b>	<b>Min</b>	<b>Max</b>
Industrial	-40°C	85°C

Notes:

- (1) The minimum DC input voltage is -0.5V. During transitions, inputs may undershoot to -2.0V for periods of less than 20 ns. Maximum DC voltage on output pins is V<sub>CC</sub> +0.5V, which may overshoot to V<sub>CC</sub> +2.0V for periods of less than 20 ns.
- (2) Latch-up protection is provided for stresses up to 100 mA on address and data pins from -1V to V<sub>CC</sub> +1V.

**POTENTIOMETER CHARACTERISTICS**

Over recommended operating conditions unless otherwise stated.

Symbol	Parameter	Test Conditions	Min	Typ	Max	Units
R <sub>POT</sub>	Potentiometer Resistance (-00)			100		kΩ
R <sub>POT</sub>	Potentiometer Resistance (-50)			50		kΩ
R <sub>POT</sub>	Potentiometer Resistance (-10)			10		kΩ
R <sub>POT</sub>	Potentiometer Resistance (-2.5)			2.5		kΩ
	Potentiometer Resistance Tolerance				±20	%
	R <sub>POT</sub> Matching				1	%
	Power Rating	25°C, each pot			50	mW
I <sub>W</sub>	Wiper Current				±6	mA
R <sub>W</sub>	Wiper Resistance	I <sub>W</sub> = ±3mA @ V <sub>CC</sub> = 3V			300	Ω
R <sub>W</sub>	Wiper Resistance	I <sub>W</sub> = ±3mA @ V <sub>CC</sub> = 5V		80	150	Ω
V <sub>TERM</sub>	Voltage on any R <sub>H</sub> or R <sub>L</sub> Pin	V <sub>SS</sub> = 0V	GND		V <sub>CC</sub>	V
V <sub>N</sub>	Noise	(1)		TBD		nV/√Hz
	Resolution	(1)		1.6		%
	Absolute Linearity (2)	R <sub>W(n)(actual)</sub> - R <sub>(n)(expected)</sub> <sup>(5)</sup>			±1	LSB (4)
	Relative Linearity (3)	R <sub>W(n+1)</sub> - [R <sub>W(n)</sub> + LSB] <sup>(5)</sup>			±0.2	LSB (4)
TC <sub>R<sub>POT</sub></sub>	Temperature Coefficient of R <sub>POT</sub>	(1)		±300		ppm/°C
TC <sub>RATIO</sub>	Ratiometric Temp. Coefficient	(1)			20	ppm/°C
C <sub>H</sub> /C <sub>L</sub> /C <sub>W</sub>	Potentiometer Capacitances	(1)		10/10/25		pF
fc	Frequency Response	R <sub>POT</sub> = 50kΩ		0.4		MHz

Notes:

- (1) This parameter is tested initially and after a design or process change that affects the parameter.
- (2) Absolute linearity is utilized to determine actual wiper voltage versus expected voltage as determined by wiper position when used as a potentiometer.
- (3) Relative linearity is utilized to determine the actual change in voltage between two successive tap positions when used as a potentiometer. It is a measure of the error in step size.
- (4) LSB = R<sub>TOT</sub> / 63 or (R<sub>H</sub> - R<sub>L</sub>) / 63, single pot
- (5) n = 0, 1, 2, ..., 63

**D.C. OPERATING CHARACTERISTICS**

Over recommended operating conditions unless otherwise stated.

Symbol	Parameter	Test Conditions	Min	Typ	Max	Units
I <sub>CC</sub>	Power Supply Current	f <sub>SCK</sub> = 2MHz, SO Open Inputs = GND			1	mA
I <sub>SB</sub>	Standby Current (V <sub>CC</sub> = 5.0V)	V <sub>IN</sub> = GND or V <sub>CC</sub> ; SO Open			1	μA
I <sub>LI</sub>	Input Leakage Current	V <sub>IN</sub> = GND to V <sub>CC</sub>			10	μA
I <sub>LO</sub>	Output Leakage Current	V <sub>OUT</sub> = GND to V <sub>CC</sub>			10	μA
V <sub>IL</sub>	Input Low Voltage		-1		V <sub>CC</sub> x 0.3	V
V <sub>IH</sub>	Input High Voltage		V <sub>CC</sub> x 0.7		V <sub>CC</sub> + 1.0	V
V <sub>OL1</sub>	Output Low Voltage (V <sub>CC</sub> = 3.0V)	I <sub>OL</sub> = 3 mA			0.4	V

**PIN CAPACITANCE (1)**Applicable over recommended operating range from T<sub>A</sub>=25°C, f=1.0 MHz, V<sub>CC</sub>=±5.0V (unless otherwise noted).

Symbol	Test Conditions	Min	Typ	Max	Units	Conditions
C <sub>OUT</sub>	Output Capacitance (SO)			8	pF	V <sub>OUT</sub> =0V
C <sub>IN</sub>	Input Capacitance ( $\overline{CS}$ , SCK, SI, $\overline{WP}$ , $\overline{HOLD}$ )			6	pF	V <sub>IN</sub> =0V

**A.C. CHARACTERISTICS**

Over recommended operating conditions unless otherwise stated.

SYMBOL	PARAMETER	Min	Typ	Max	UNITS	Test Conditions
t <sub>SU</sub>	Data Setup Time	50			ns	
t <sub>H</sub>	Data Hold Time	50			ns	
t <sub>WH</sub>	SCK High Time	125			ns	
t <sub>WL</sub>	SCK Low Time	125			ns	
f <sub>SCK</sub>	Clock Frequency	DC		3	MHz	
t <sub>LZ</sub>	$\overline{\text{HOLD}}$ to Output Low Z			50	ns	
t <sub>RI</sub> <sup>(1)</sup>	Input Rise Time			2	μs	
t <sub>FI</sub> <sup>(1)</sup>	Input Fall Time			2	μs	
t <sub>HD</sub>	$\overline{\text{HOLD}}$ Setup Time	100			ns	
t <sub>CD</sub>	$\overline{\text{HOLD}}$ Hold Time	100			ns	
t <sub>WC</sub>	Write Cycle Time			10	ms	
t <sub>V</sub>	Output Valid from Clock Low			250	ns	
t <sub>HO</sub>	Output Hold Time	0			ns	
t <sub>DIS</sub>	Output Disable Time			250	ns	
t <sub>HZ</sub>	$\overline{\text{HOLD}}$ to Output High Z			100	ns	
t <sub>CS</sub>	$\overline{\text{CS}}$ High Time	250			ns	
t <sub>CSS</sub>	$\overline{\text{CS}}$ Setup Time	250			ns	
t <sub>CSH</sub>	$\overline{\text{CS}}$ Hold Time	250			ns	

NOTE:

(1) This parameter is tested initially and after a design or process change that affects the parameter.

**POWER UP TIMING (1)**

Over recommended operating conditions unless otherwise stated.

Symbol	Parameter	Min	Typ	Max	Units
t <sub>PUR</sub>	Power-up to Read Operation			1	ms
t <sub>PUW</sub>	Power-up to Write Operation			1	ms

Note:

(1) This parameter is tested initially and after a design or process change that affects the parameter.

**WRITE CYCLE LIMITS**

Over recommended operating conditions unless otherwise stated.

Symbol	Parameter	Min	Typ	Max	Units
$t_{WR}$	Write Cycle Time			5	ms

**RELIABILITY CHARACTERISTICS**

Over recommended operating conditions unless otherwise stated.

Symbol	Parameter	Reference Test Method	Min	Typ	Max	Units
$N_{END}^{(1)}$	Endurance	MIL-STD-883, Test Method 1033	1,000,000			Cycles/Byte
$T_{DR}^{(1)}$	Data Retention	MIL-STD-883, Test Method 1008	100			Years
$V_{ZAP}^{(1)}$	ESD Susceptibility	MIL-STD-883, Test Method 3015	2000			Volts
$I_{LTH}^{(1)}$	Latch-Up	JEDEC Standard 17	100			mA

**Figure 1. Synchronous Data Timing**

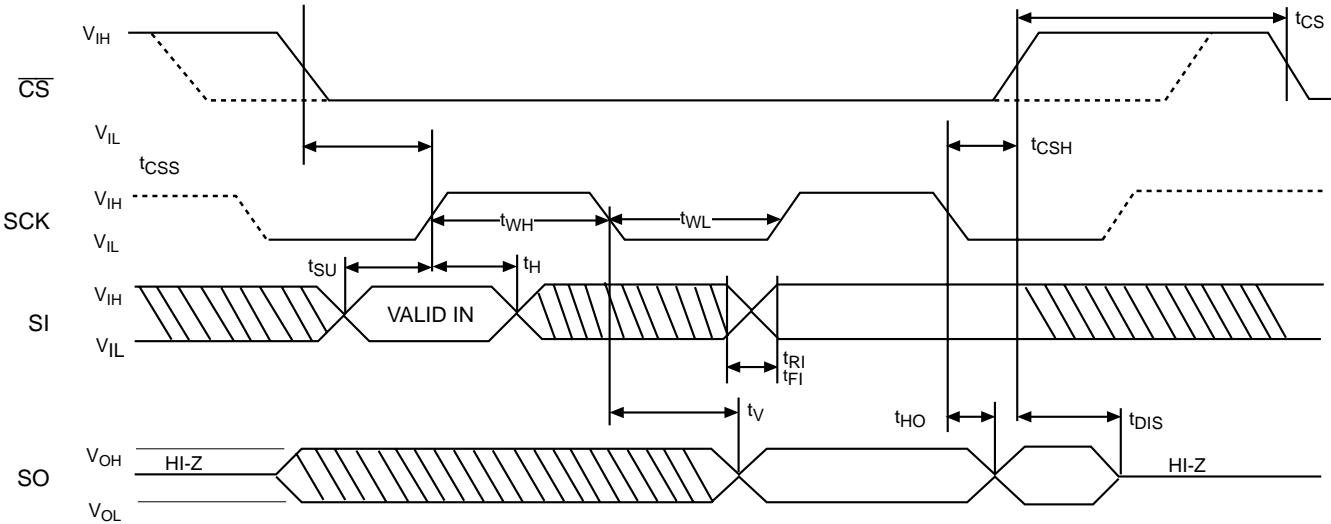

**Figure 2. HOLD Timing**

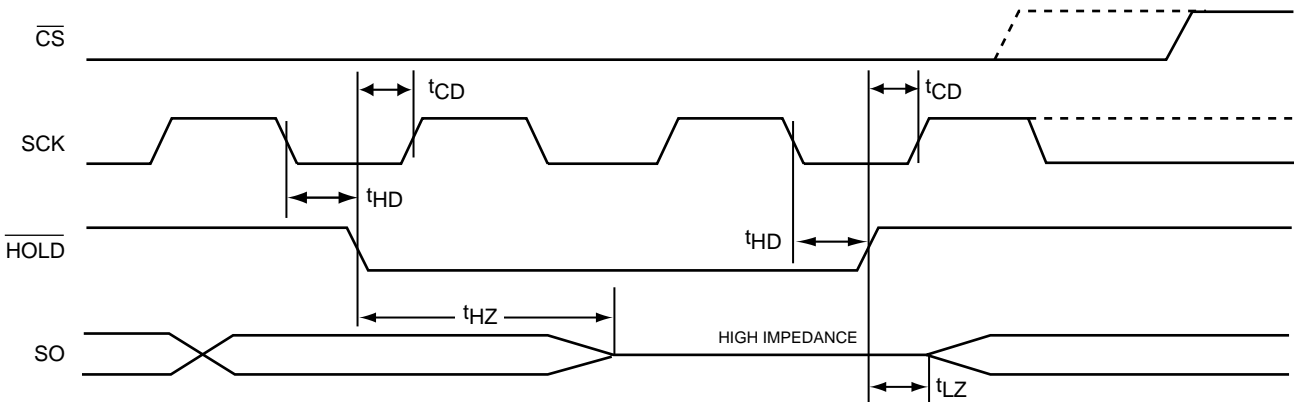

Note:

- (1) This parameter is tested initially and after a design or process change that affects the parameter.
- (2)  $t_{PUR}$  and  $t_{PUW}$  are the delays required from the time  $V_{CC}$  is stable until the specified operation can be initiated.
- (3) Dashed Line= mode (1, 1) - - - - -

## INSTRUCTION AND REGISTER DESCRIPTION

### DEVICE TYPE / ADDRESS BYTE

The first byte sent to the CAT5401 from the master/processor is called the Device Address Byte. The most significant four bits of the Device Type address are a device type identifier. These bits for the CAT5401 are fixed at 0101[B] (refer to Table 1).

The two least significant bits in the slave address byte, A1 - A0, are the internal slave address and must match the physical device address which is defined by the state of the A1 - A0 input pins for the CAT5401 to successfully continue the command sequence. Only the device which slave address matches the incoming device address sent by the master executes the instruction. The A1 - A0 inputs can be actively driven by CMOS input signals or tied to V<sub>CC</sub> or V<sub>SS</sub>. The remaining two bits in the device address byte must be set to 0.

### INSTRUCTION BYTE

The next byte sent to the CAT5401 contains the instruction and register pointer information. The four most significant bits used provide the instruction opcode I [3:0]. The R1 and R0 bits point to one of the four data registers of each associated potentiometer. The least two significant bits point to one of four Wiper Control Registers. The format is shown in Table 2.

### Data Register Selection

Data Register Selected	R1	R0
DR0	0	0
DR1	0	1
DR2	1	0
DR3	1	1

**Table 1. Identification Byte Format**

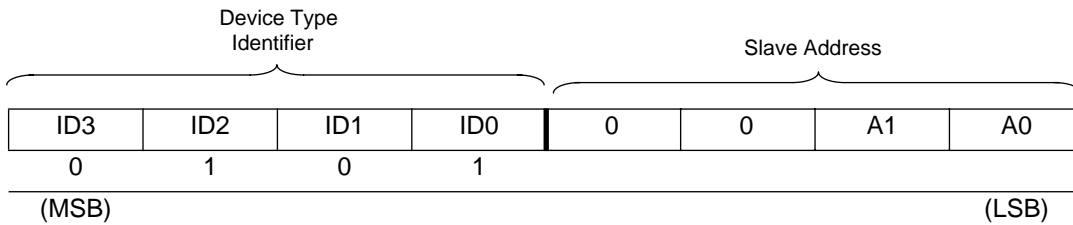

**Table 2. Instruction Byte Format**

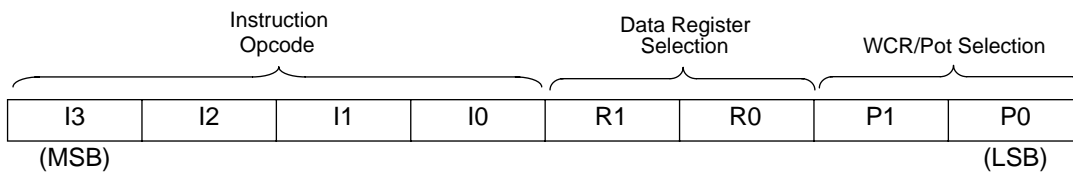



## WIPER CONTROL AND DATA REGISTERS

### Wiper Control Register (WCR)

The CAT5401 contains four 6-bit Wiper Control Registers, one for each potentiometer. The Wiper Control Register output is decoded to select one of 64 switches along its resistor array. The contents of the WCR can be altered in four ways: it may be written by the host via Write Wiper Control Register instruction; it may be written by transferring the contents of one of four associated Data Registers via the XFR Data Register instruction, it can be modified one step at a time by the Increment/decrement instruction (see Instruction section for more details). Finally, it is loaded with the content of its data register zero (DR0) upon power-up.

The Wiper Control Register is a volatile register that loses its contents when the CAT5401 is powered-down. Although the register is automatically loaded with the value in DR0 upon power-up, this may be different from the value present at power-down.

### Data Registers (DR)

Each potentiometer has four 6-bit non-volatile Data Registers. These can be read or written directly by the host. Data can also be transferred between any of the

four Data Registers and the associated Wiper Control Register. Any data changes in one of the Data Registers is a non-volatile operation and will take a maximum of 5ms.

### Write in Process

The contents of the Data Registers are saved to nonvolatile memory when the CS input goes HIGH after a write sequence is received. The status of the internal write cycle can be monitored by issuing a Read Status command to read the Write in Process (WIP) bit.

## INSTRUCTIONS

Five of the ten instructions are three bytes in length. These instructions are:

- **Read Wiper Control Register** - read the current wiper position of the selected potentiometer in the WCR
- **Write Wiper Control Register** - change current wiper position in the WCR of the selected potentiometer
- **Read Data Register** - read the contents of the selected Data Register
- **Write Data Register** - write a new value to the selected Data Register
- **Read Status** - Read the status of the WIP bit which

**Table 3. Instruction Set**

Instruction	Instruction Set								Operation
	I3	I2	I1	I0	R1	R0	WCR1/ P1	WCR0/ P0	
Read Wiper Control Register	1	0	0	1	0	0	1/0	1/0	Read the contents of the Wiper Control Register pointed to by P1-P0
Write Wiper Control Register	1	0	1	0	0	0	1/0	1/0	Write new value to the Wiper Control Register pointed to by P1-P0
Read Data Register	1	0	1	1	1/0	1/0	1/0	1/0	Read the contents of the Data Register pointed to by P1-P0 and R1-R0
Write Data Register	1	1	0	0	1/0	1/0	1/0	1/0	Write new value to the Data Register pointed to by P1-P0 and R1-R0
XFR Data Register to Wiper Control Register	1	1	0	1	1/0	1/0	1/0	1/0	Transfer the contents of the Data Register pointed to by P1-P0 and R1-R0 to its associated Wiper Control Register
XFR Wiper Control Register to Data Register	1	1	1	0	1/0	1/0	1/0	1/0	Transfer the contents of the Wiper Control Register pointed to by P1-P0 to the Data Register pointed to by R1-R0
Global XFR Data Registers to Wiper Control Registers	0	0	0	1	1/0	1/0	0	0	Transfer the contents of the Data Registers pointed to by R1-R0 of all four pots to their respective Wiper Control Register
Global XFR Wiper Control Registers to Data Register	1	0	0	0	1/0	1/0	0	0	Transfer the contents of both Wiper Control Registers to their respective data Registers pointed to by R1-R0 of all four pots
Increment/Decrement Wiper Control Register	0	0	1	0	0	0	1/0	1/0	Enable Increment/decrement of the Control Latch pointed to by P1-P0
Read Status (WIP bit)	0	1	0	1	0	0	0	1	Read WIP bit to check internal write cycle status

**Note:** 1/0 = data is one or zero

when set to "1" signifies a write cycle is in progress.

The basic sequence of the three byte instructions is illustrated in Figure 8. These three-byte instructions exchange data between the WCR and one of the Data Registers. The WCR controls the position of the wiper. The response of the wiper to this action will be delayed by  $t_{WRL}$ . A transfer from the WCR (current wiper position), to a Data Register is a write to non-volatile memory and takes a minimum of  $t_{WR}$  to complete. The transfer can occur between one of the four potentiometers and one of its associated registers; or the transfer can occur between all potentiometers and one associated register.

Four instructions require a two-byte sequence to complete, as illustrated in Figure 7. These instructions transfer data between the host/processor and the CAT5401; either between the host and one of the data registers or directly between the host and the Wiper Control Register. These instructions are:

- **XFR Data Register to Wiper Control Register**  
This transfers the contents of one specified Data Register to the associated Wiper Control Register.
- **XFR Wiper Control Register to Data Register**  
This transfers the contents of the specified Wiper Control Register to the specified associated Data Register.
- **Global XFR Data Register to Wiper**

**Control Register**

This transfers the contents of all specified Data Registers to the associated Wiper Control Registers.

— **Global XFR Wiper Counter Register to Data Register**

This transfers the contents of all Wiper Control Registers to the specified associated Data Registers.

**INCREMENT/DECREMENT COMMAND**

The final command is Increment/Decrement (Figure 5 and 9). The Increment/Decrement command is different from the other commands. Once the command is issued the master can clock the selected wiper up and/or down in one segment steps; thereby providing a fine tuning capability to the host. For each SCK clock pulse ( $t_{HIGH}$ ) while SI is HIGH, the selected wiper will move one resistor segment towards the  $R_H$  terminal. Similarly, for each SCK clock pulse while SI is LOW, the selected wiper will move one resistor segment towards the  $R_L$  terminal.

See Instructions format for more detail.

**Figure 7. Two-Byte Instruction Sequence**

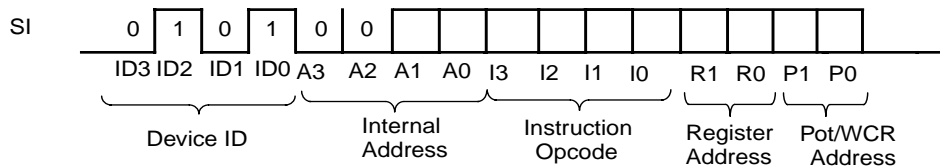

**Figure 8. Three-Byte Instruction Sequence**

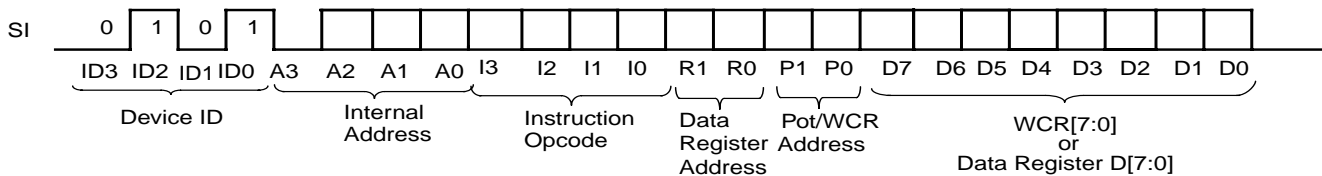

**Figure 9. Increment/Decrement Instruction Sequence**

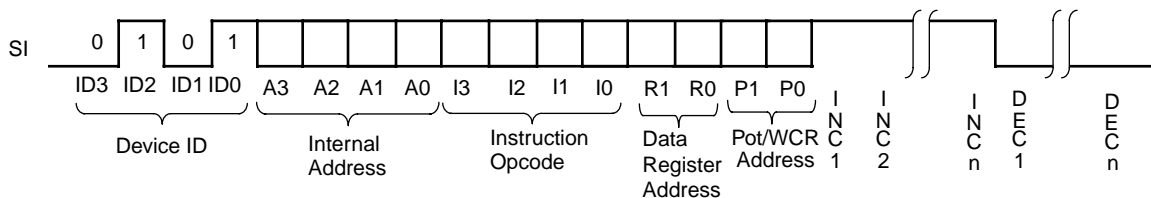
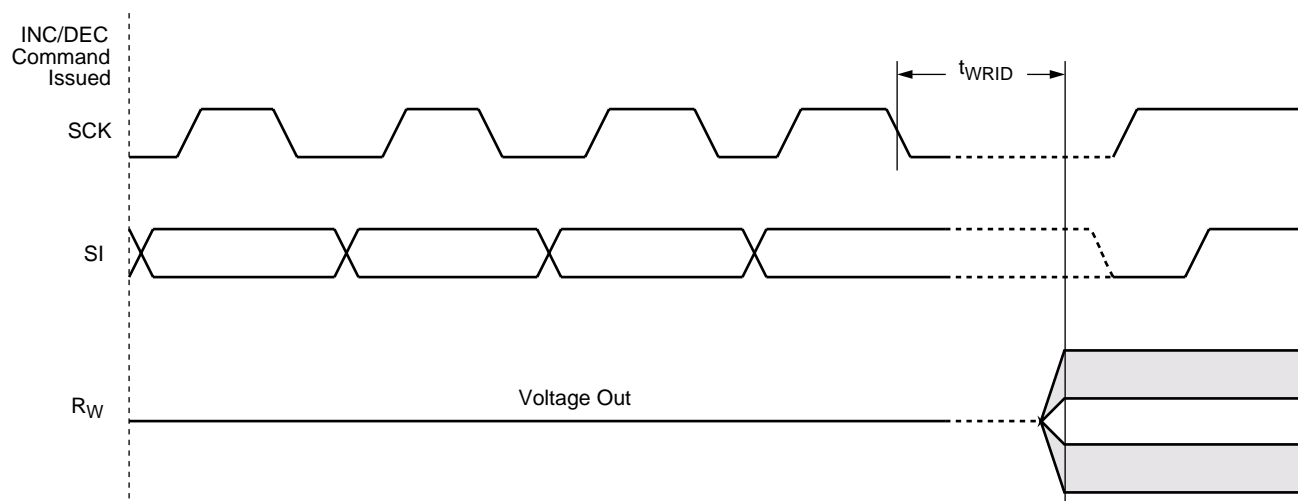

Figure 10. Increment/Decrement Timing Limits



### INSTRUCTION FORMAT

#### Read Wiper Control Register (WCR)

	DEVICE ADDRESSES						INSTRUCTION				DATA														
$\overline{CS}$	0	1	0	1	0	0	A1	A0	1	0	0	1	0	0	P1	P0	7	6	5	4	3	2	1	0	$\overline{CS}$
																	0	0							

#### Write Wiper Control Register (WCR)

	DEVICE ADDRESSES						INSTRUCTION				DATA														
$\overline{CS}$	0	1	0	1	0	0	A1	A0	1	0	1	0	0	0	P1	P0	7	6	5	4	3	2	1	0	$\overline{CS}$
																	0	0							

#### Read Data Register (DR)

	DEVICE ADDRESSES						INSTRUCTION				DATA														
$\overline{CS}$	0	1	0	1	0	0	A1	A0	1	0	1	1	R1	R0	P1	P0	7	6	5	4	3	2	1	0	$\overline{CS}$

#### Write Data Register (DR)

	DEVICE ADDRESSES						INSTRUCTION				DATA															
$\overline{CS}$	0	1	0	1	0	0	A1	A0	1	1	0	0	R1	R0	P1	P0	7	6	5	4	3	2	1	0	$\overline{CS}$	High Voltage Write Cycle

#### Read (WIP) Status

	DEVICE ADDRESSES						INSTRUCTION				DATA														
$\overline{CS}$	0	1	0	1	0	0	A1	A0	0	1	0	1	0	0	0	1	7	6	5	4	3	2	1	W	$\overline{CS}$
																0	0	0	0	0	0	0	0	I	
																								P	

**INSTRUCTION FORMAT** (continued)

**Global Transfer Data Register (DR) to Wiper Control Register (WCR)**

	DEVICE ADDRESSES								INSTRUCTION								
$\overline{CS}$	0	1	0	1	0	0	A1	A0	0	0	0	1	R1	R0	0	0	$\overline{CS}$

**Global Transfer Wiper Control Register (WCR) to Data Register (DR)**

	DEVICE ADDRESSES								INSTRUCTION									
$\overline{CS}$	0	1	0	1	0	0	A1	A0	1	0	0	0	R1	R0	0	0	$\overline{CS}$	High Voltage Write Cycle

**Transfer Wiper Control Register (WCR) to Data Register (DR)**

	DEVICE ADDRESSES								INSTRUCTION									
$\overline{CS}$	0	1	0	1	0	0	A1	A0	1	1	1	0	R1	R0	P1	P0	$\overline{CS}$	High Voltage Write Cycle

**Transfer Data Register (DR) to Wiper Control Register (WCR)**

	DEVICE ADDRESSES								INSTRUCTION								
$\overline{CS}$	0	1	0	1	0	0	A1	A0	1	1	0	1	R1	R0	P1	P0	$\overline{CS}$

**Increment (I)/Decrement (D) Wiper Control Register (WCR)**

	DEVICE ADDRESSES								INSTRUCTION								DATA						
$\overline{CS}$	0	1	0	1	0	0	A1	A0	0	0	1	0	0	0	P1	P0	I/D	I/D			I/D	I/D	$\overline{CS}$

Notes:

(1) Any write or transfer to the Non-volatile Data Registers is followed by a high voltage cycle after  $\overline{CS}$  goes high.

**ORDERING INFORMATION**

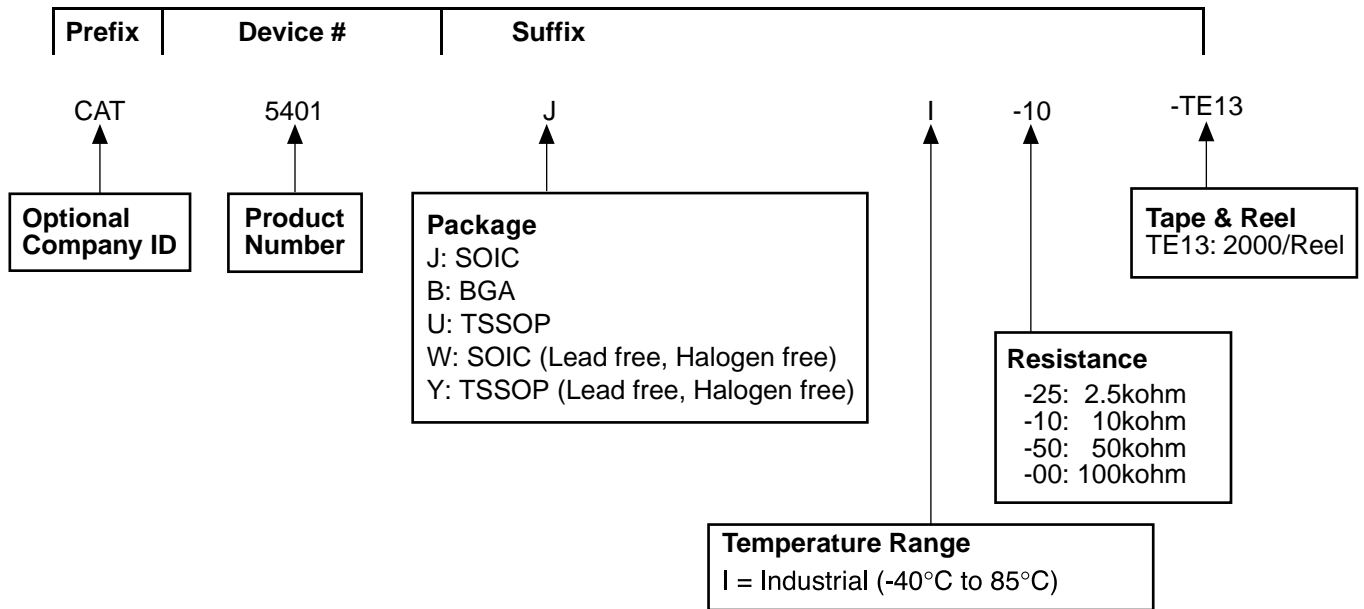

**Notes:**

(1) The device used in the above example is a CAT5401JI-10-TE13 (SOIC, Industrial Temperature, 10kohm, Tape & Reel)

PACKAGING INFORMATION

24-LEAD 300 MIL WIDE SOIC (J)

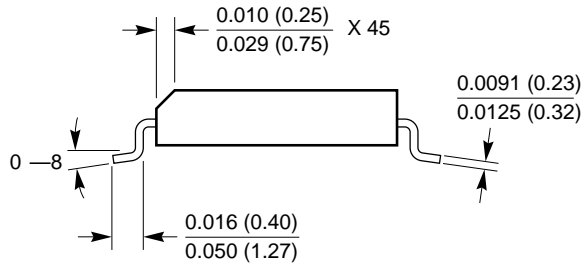
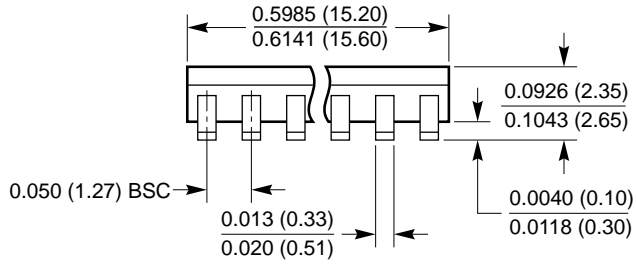
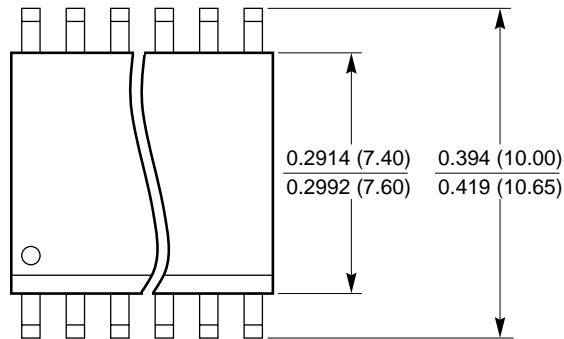

**PACKAGING INFORMATION CON'T**  
**24 Lead TSSOP (U)**

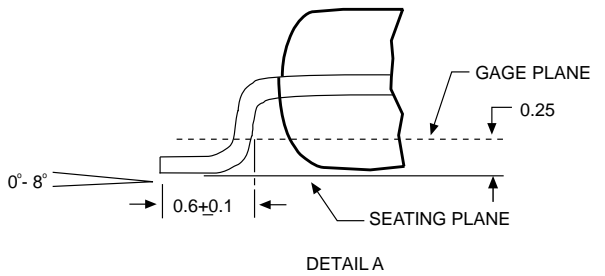
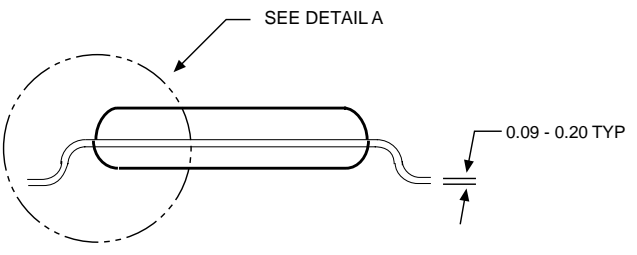
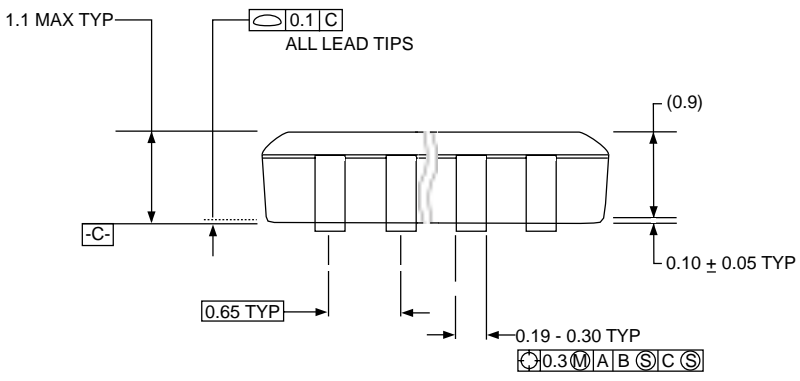
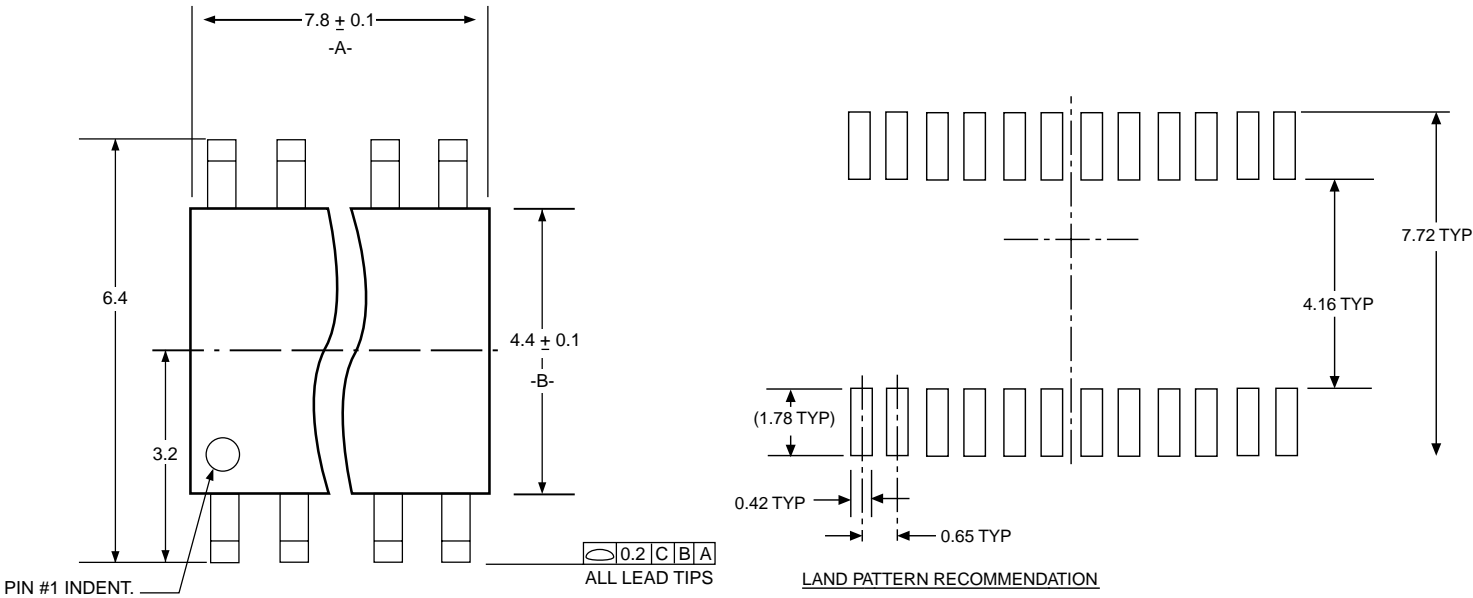

**PACKAGING INFORMATION CON'T**  
**24 Ball BGA**

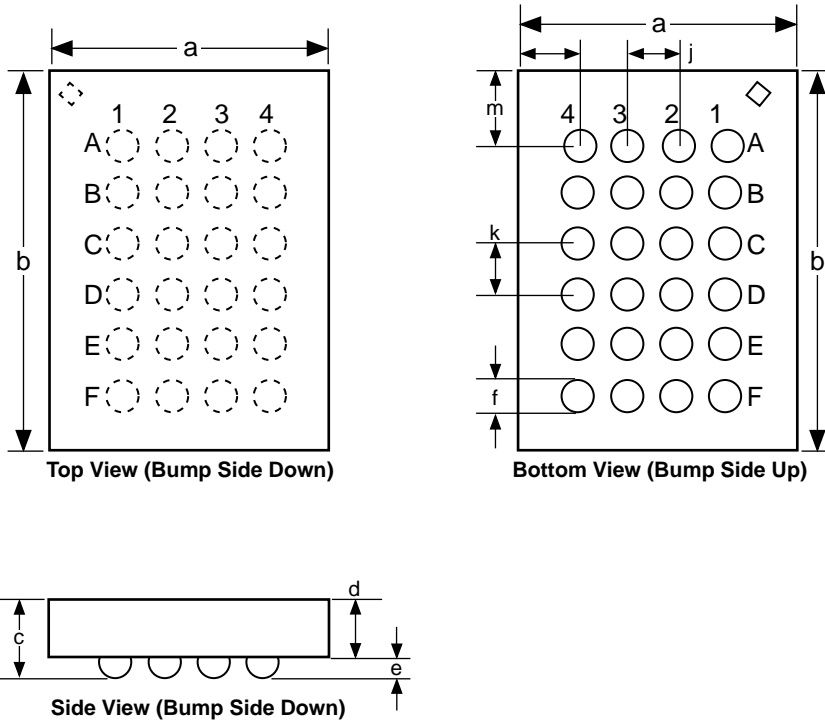

	Symbol	Millimeters			Inches		
		Min	Nom	Max	Nom	Min	Max
Package Body Dimension X	a	TBD	TBD	TBD	TBD	TBD	TBD
Package Body Dimension Y	b	TBD	TBD	TBD	TBD	TBD	TBD
Package Height	c	0.635	0.505	0.765	0.02500	0.01988	0.03012
Package Body Thickness	d	0.433	0.395	0.471	0.01705	0.01555	0.01854
Ball Height	e	0.202	0.110	0.294	0.00795	0.00433	0.01157
Ball Diameter	f	0.284	0.180	0.388	0.01118	0.00709	0.01528
Total Ball Count	g	24					
Ball Count X Axis	h	4					
Ball Count Y Axis	i	6					
Pins Pitch X Axis	j	0.5					
Pins Pitch Y Axis	k	0.5					
Edge to Ball Center (Corner) Distance Along X	l	TBD	TBD	TBD	TBD	TBD	TBD
Edge to Ball Center (Corner) Distance Along Y	m	TBD	TBD	TBD	TBD	TBD	TBD



## REVISION HISTORY

Date	Rev.	Reason
3/31/2004	F	Changed Preliminary designation to Final Eliminated Commercial temp range in all areas Updated Potentiometer characteristics notes Updated Pin Descriptions (A0, A1 and $\overline{WP}$ ) Updated notes for Absolute Max Ratings and Potentiometer Characteristics

---

### Copyrights, Trademarks and Patents

Trademarks and registered trademarks of Catalyst Semiconductor include each of the following:

DPP™    DPPs™    AE™

Catalyst Semiconductor has been issued U.S. and foreign patents and has patent applications pending that protect its products. For a complete list of patents issued to Catalyst Semiconductor contact the Company's corporate office at 408.542.1000.

*CATALYST SEMICONDUCTOR MAKES NO WARRANTY, REPRESENTATION OR GUARANTEE, EXPRESS OR IMPLIED, REGARDING THE SUITABILITY OF ITS PRODUCTS FOR ANY PARTICULAR PURPOSE, NOR THAT THE USE OF ITS PRODUCTS WILL NOT INFRINGE ITS INTELLECTUAL PROPERTY RIGHTS OR THE RIGHTS OF THIRD PARTIES WITH RESPECT TO ANY PARTICULAR USE OR APPLICATION AND SPECIFICALLY DISCLAIMS ANY AND ALL LIABILITY ARISING OUT OF ANY SUCH USE OR APPLICATION, INCLUDING BUT NOT LIMITED TO, CONSEQUENTIAL OR INCIDENTAL DAMAGES.*

Catalyst Semiconductor products are not designed, intended, or authorized for use as components in systems intended for surgical implant into the body, or other applications intended to support or sustain life, or for any other application in which the failure of the Catalyst Semiconductor product could create a situation where personal injury or death may occur.

Catalyst Semiconductor reserves the right to make changes to or discontinue any product or service described herein without notice. Products with data sheets labeled "Advance Information" or "Preliminary" and other products described herein may not be in production or offered for sale.

Catalyst Semiconductor advises customers to obtain the current version of the relevant product information before placing orders. Circuit diagrams illustrate typical semiconductor applications and may not be complete.

---



# CATALYST

Catalyst Semiconductor, Inc.  
Corporate Headquarters  
1250 Borregas Avenue  
Sunnyvale, CA 94089  
Phone: 408.542.1000  
Fax: 408.542.1200  
[www.catalyst-semiconductor.com](http://www.catalyst-semiconductor.com)

Publication #: 2010  
Revision: F  
Issue date: 3/31/04  
Type: Final