

ILONA-M

~25° wide beam

SPECIFICATION:

Dimensions	Ø 49.8 mm
Height	29.7 mm
Fastening	socket
ROHS compliant	yes ⓘ

MATERIALS:

Component	Type	Material	Colour	Finish
ILONA-M	Single lens	PMMA	clear	

ORDERING INFORMATION:





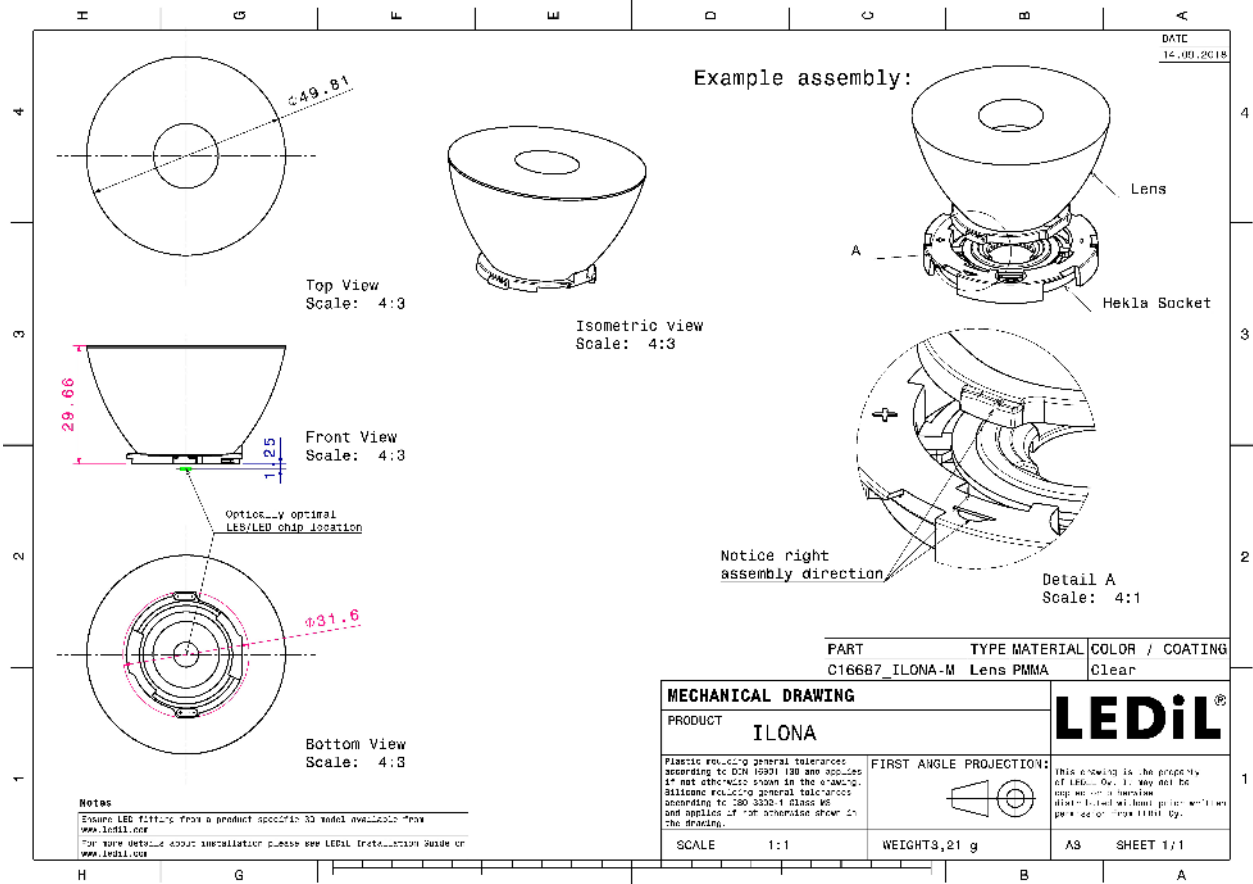





Component	Qty in box	MOQ	MPQ	Box weight (kg)
C16687_ILONA-M » Box size: 480 x 280 x 300 mm	264	99	33	9.9

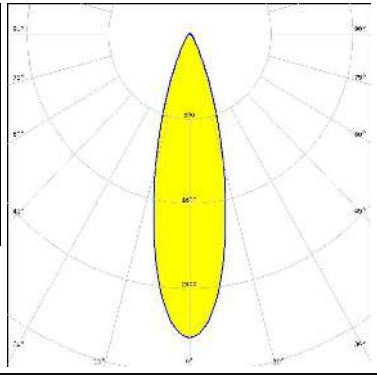

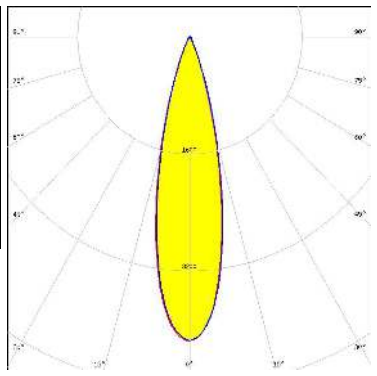

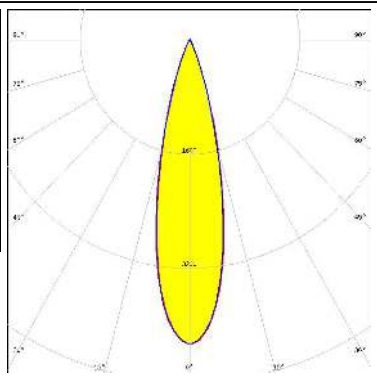





See also our general installation guide: www.ledil.com/installation_guide

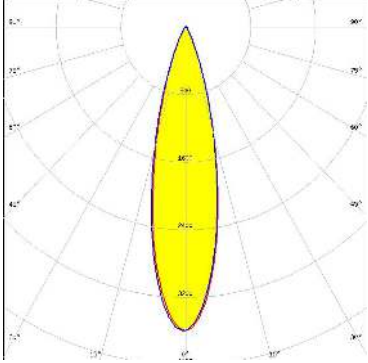

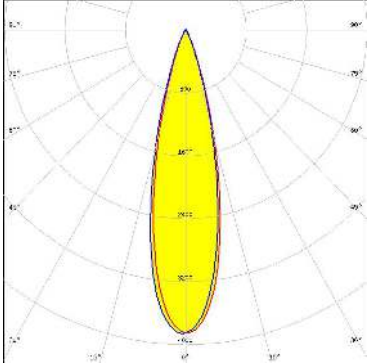

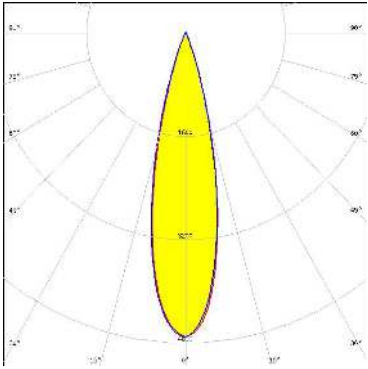
OPTICAL RESULTS (MEASURED):

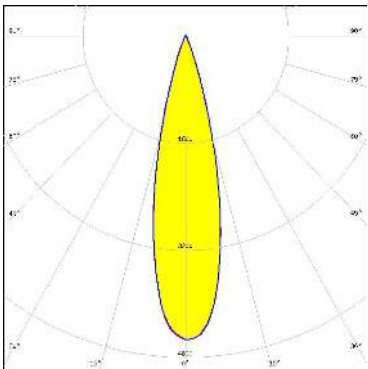
<p></p> <p>LED V11 HD Gen 8</p> <p>FWHM / FWTM 28.0° / 53.0°</p> <p>Efficiency 92 %</p> <p>Peak intensity 2.9 cd/lm</p> <p>LEDs/each optic 1</p> <p>Light colour White</p> <p>Required components: Bender Wirth: 633d Hekla</p>		
<p></p> <p>LED V6 HD Gen 7</p> <p>FWHM / FWTM 25.0° / 44.0°</p> <p>Efficiency 95 %</p> <p>Peak intensity 4.2 cd/lm</p> <p>LEDs/each optic 1</p> <p>Light colour White</p> <p>Required components: Bender Wirth: 634c Hekla</p>		
<p></p> <p>LED V6 HD Gen 7</p> <p>FWHM / FWTM 25.0° / 44.0°</p> <p>Efficiency 95 %</p> <p>Peak intensity 4.3 cd/lm</p> <p>LEDs/each optic 1</p> <p>Light colour White</p> <p>Required components: F15255_HEKLA-SOCKET-C</p>		
<p></p> <p>LED Vesta DTW 13mm (21W)</p> <p>FWHM / FWTM 31.0° / 61.0°</p> <p>Efficiency 90 %</p> <p>Peak intensity 2.2 cd/lm</p> <p>LEDs/each optic 1</p> <p>Light colour Tunable White</p> <p>Required components: C16142_HEKLA-SOCKET-K Bender Wirth: 491 Typ L8</p>		

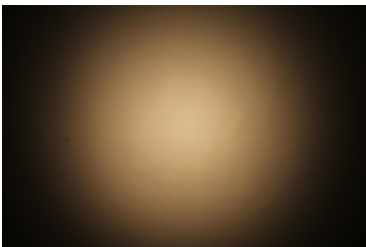
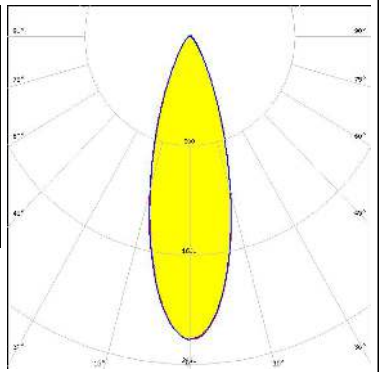

OPTICAL RESULTS (MEASURED):

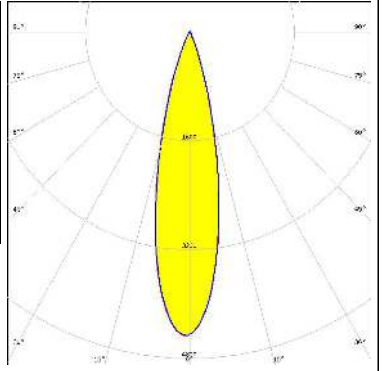
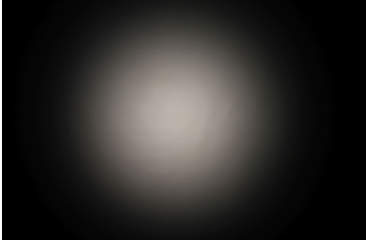
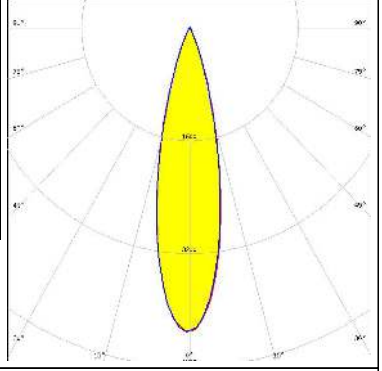
<p></p> <p>LED Vesta DTW 9mm (4W/6W/12W)</p> <p>FWHM / FWTM 25.0° / 48.0°</p> <p>Efficiency 93 %</p> <p>Peak intensity 3.6 cd/lm</p> <p>LEDs/each optic 1</p> <p>Light colour White</p> <p>Required components: C16142_HEKLA-SOCKET-K Bender Wirth: 490 Typ L8</p>		
<p></p> <p>LED Vesta TW 6mm DP</p> <p>FWHM / FWTM 26.0° / 45.0°</p> <p>Efficiency 91 %</p> <p>Peak intensity 3.9 cd/lm</p> <p>LEDs/each optic 1</p> <p>Light colour White</p> <p>Required components: C16142_HEKLA-SOCKET-K Bender Wirth: 504 Typ L8</p>		
<p>CITIZEN</p> <p>LED CLU7A2/7A3</p> <p>FWHM / FWTM 25.0° / 41.0°</p> <p>Efficiency 94 %</p> <p>Peak intensity 4.7 cd/lm</p> <p>LEDs/each optic 1</p> <p>Light colour White</p> <p>Required components: F15255_HEKLA-SOCKET-C</p>		
<p>CITIZEN</p> <p>LED CLU7B2</p> <p>FWHM / FWTM 25.0° / 41.0°</p> <p>Efficiency 94 %</p> <p>Peak intensity 4.5 cd/lm</p> <p>LEDs/each optic 1</p> <p>Light colour White</p> <p>Required components: F15255_HEKLA-SOCKET-C</p>		

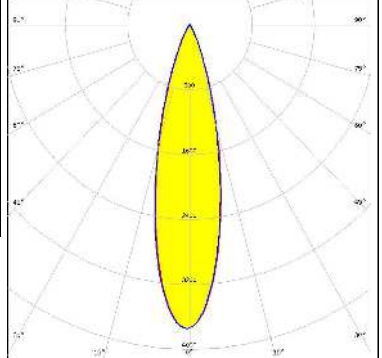

OPTICAL RESULTS (MEASURED):

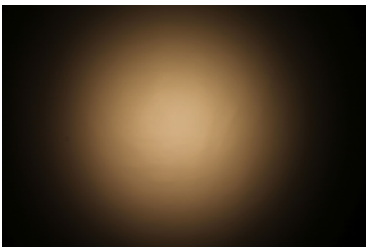
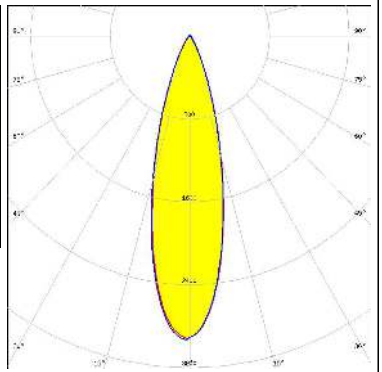
<p>LUMILEDS</p> <p>LED LUXEON CX Plus CoB L08 (Gen2)</p> <p>FWHM / FWTM 32.0° / 62.0°</p> <p>Efficiency 92 %</p> <p>Peak intensity 2.2 cd/m</p> <p>LEDs/each optic 1</p> <p>Light colour White</p> <p>Required components: Bender Wirth: 637a Hekla</p>		
<p>LUMILEDS</p> <p>LED LUXEON CX Plus CoB - HD S01H4</p> <p>FWHM / FWTM 25.0° / 43.0°</p> <p>Efficiency 94 %</p> <p>Peak intensity 4.5 cd/m</p> <p>LEDs/each optic 1</p> <p>Light colour White</p> <p>Required components: Bender Wirth: 634c Hekla</p>		
<p>LUMILEDS</p> <p>LED LUXEON CX Plus CoB - HD S01H6 / HD S02H6</p> <p>FWHM / FWTM 25.0° / 44.0°</p> <p>Efficiency 94 %</p> <p>Peak intensity 4.3 cd/m</p> <p>LEDs/each optic 1</p> <p>Light colour White</p> <p>Required components: Bender Wirth: 634c Hekla</p>		
<p>LUMILEDS</p> <p>LED LUXEON CX Plus CoB - HD S04H9</p> <p>FWHM / FWTM 25.0° / 48.0°</p> <p>Efficiency 94 %</p> <p>Peak intensity 3.8 cd/m</p> <p>LEDs/each optic 1</p> <p>Light colour White</p> <p>Required components: Bender Wirth: 634c Hekla</p>		

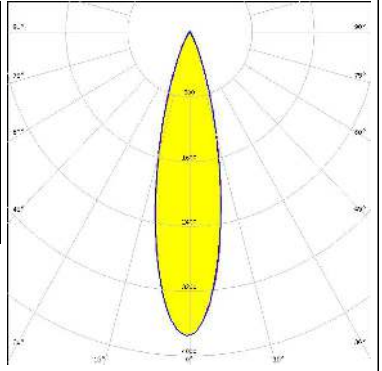
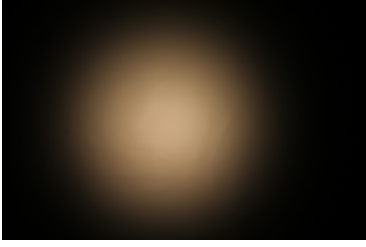
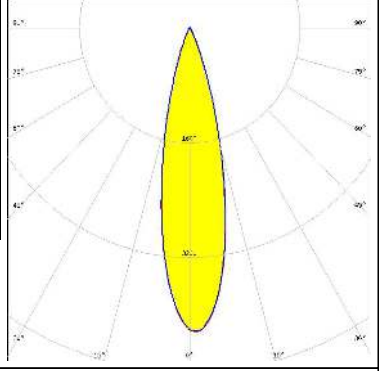
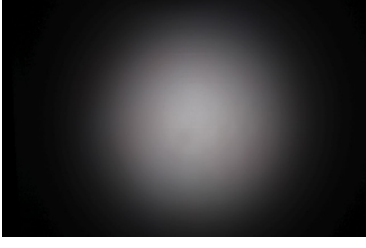
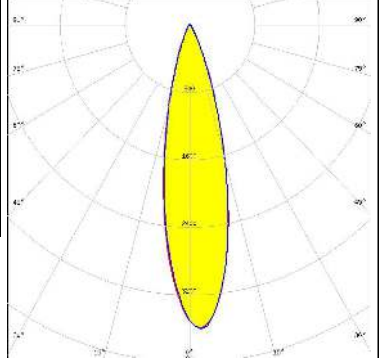
OPTICAL RESULTS (MEASURED):

<p>LUMILEDS</p> <p>LED LUXEON CX Plus CoB L04 / L05 (Gen2)</p> <p>FWHM / FWTM 28.0° / 54.0°</p> <p>Efficiency 93 %</p> <p>Peak intensity 2.9 cd/m</p> <p>LEDs/each optic 1</p> <p>Light colour White</p> <p>Required components: Bender Wirth: 637a Hekla</p>		
<p>LUMILEDS</p> <p>LED LUXEON CX Plus CoB M02 / M03 (Gen2)</p> <p>FWHM / FWTM 25.0° / 48.0°</p> <p>Efficiency 94 %</p> <p>Peak intensity 3.8 cd/m</p> <p>LEDs/each optic 1</p> <p>Light colour White</p> <p>Required components: Bender Wirth: 641a Hekla</p>		
<p>LUMILEDS</p> <p>LED LUXEON CX Plus CoB S01 (Gen2)</p> <p>FWHM / FWTM 25.0° / 44.0°</p> <p>Efficiency 94 %</p> <p>Peak intensity 4.3 cd/m</p> <p>LEDs/each optic 1</p> <p>Light colour White</p> <p>Required components: Bender Wirth: 634c Hekla</p>		
<p>LUMILEDS</p> <p>LED LUXEON Fusion 21-up (20x24)</p> <p>FWHM / FWTM 25.0° / 47.0°</p> <p>Efficiency 94 %</p> <p>Peak intensity 3.7 cd/m</p> <p>LEDs/each optic 21</p> <p>Light colour White</p> <p>Required components: C16142_HEKLA-SOCKET-K Bender Wirth: 442 Typ L8</p>		

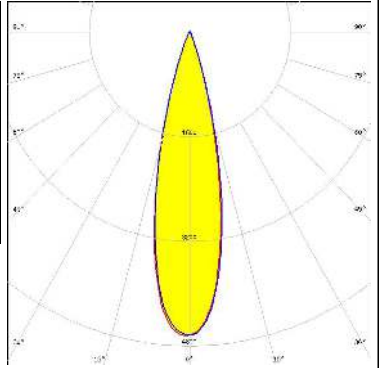
OPTICAL RESULTS (MEASURED):

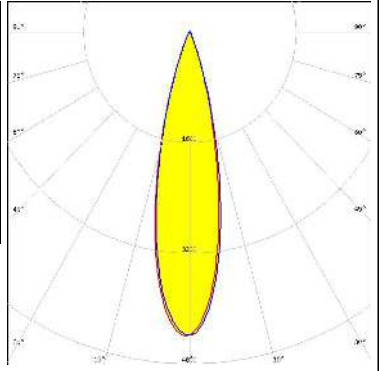
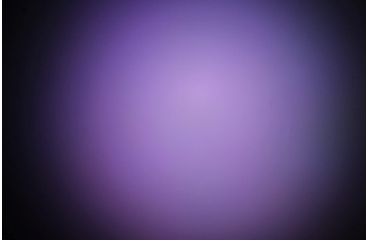
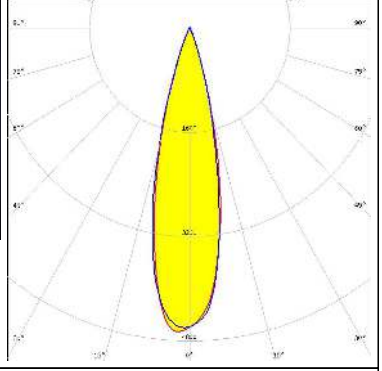
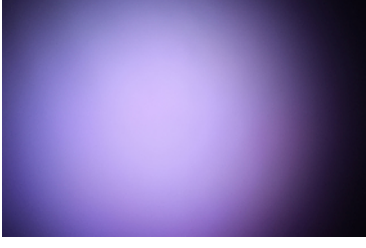
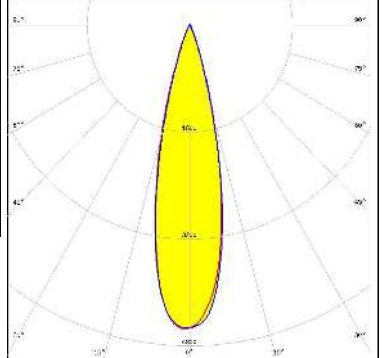
<p>LUMINUS</p> <p>LED CXM-3 FWHM / FWTM 25.0° / 41.0° Efficiency 94 % Peak intensity 4.6 cd/m LEDs/each optic 1 Light colour White Required components: F15255_HEKLA-SOCKET-C</p>		
<p>LUMINUS</p> <p>LED CXM-4 FWHM / FWTM 24.0° / 42.0° Efficiency 92 % Peak intensity 4.4 cd/m LEDs/each optic 1 Light colour White Required components: F15255_HEKLA-SOCKET-C</p>		
<p>OSRAM <small>Opto Semiconductors</small></p> <p>LED OSTAR Stage (S2WN) FWHM / FWTM 25.0° / 41.0° Efficiency 94 % Peak intensity 4.7 cd/m LEDs/each optic 1 Light colour White Required components: F15859_HEKLA-SOCKET-I</p>		
<p>OSRAM <small>Opto Semiconductors</small></p> <p>LED OSTAR Stage (S2WP) FWHM / FWTM 25.0° / 41.0° Efficiency 94 % Peak intensity 4.6 cd/m LEDs/each optic 1 Light colour White Required components: F15859_HEKLA-SOCKET-I</p>		

OPTICAL RESULTS (MEASURED):

SAMSUNG

LED LC010T (Tunable White)
 FWHM / FWTM 26.0° / 51.0°
 Efficiency 88 %
 Peak intensity 2.9 cd/m
 LEDs/each optic 1
 Light colour Tunable White
 Required components:
 C16142_HEKLA-SOCKET-K
 Bender Wirth: 501 Typ L8

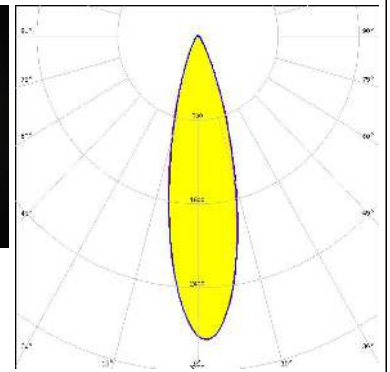

SEOUL SEMICONDUCTOR
 LED MJT COB LES 14.5
 FWHM / FWTM 34.0° / 64.0°
 Efficiency 93 %
 Peak intensity 2 cd/m
 LEDs/each optic 1
 Light colour White
 Required components:
 F17438_HEKLA-G2-I

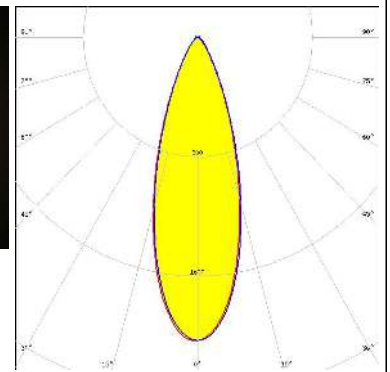
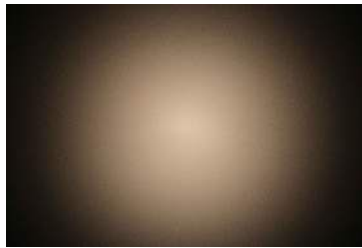

SEOUL SEMICONDUCTOR
 LED MJT COB LES 6
 FWHM / FWTM 26.0° / 44.0°
 Efficiency 95 %
 Peak intensity 4.2 cd/m
 LEDs/each optic 1
 Light colour White
 Required components:
 F17435_HEKLA-G2-C

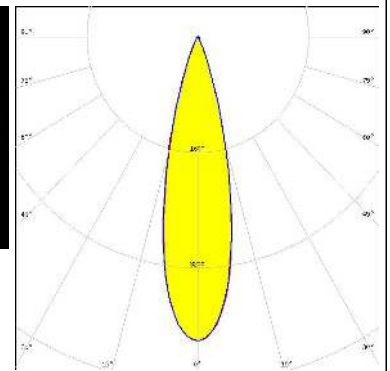

SEOUL SEMICONDUCTOR
 LED MJT COB LES 9.8
 FWHM / FWTM 26.0° / 49.0°
 Efficiency 95 %
 Peak intensity 3.6 cd/m
 LEDs/each optic 1
 Light colour White
 Required components:
 F17435_HEKLA-G2-C

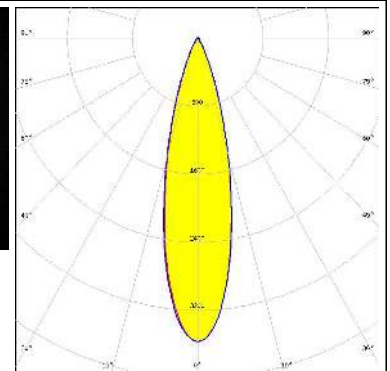

OPTICAL RESULTS (MEASURED):

TRIDONIC

LED SLE G7 LES09
FWHM / FWTM 25.0° / 48.0°
Efficiency 94 %
Peak intensity 3.7 cd/lm
LEDs/each optic 1
Light colour White
Required components:
F15255_HEKLA-SOCKET-C

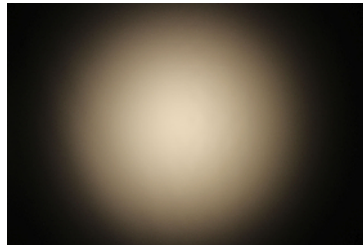

XICATO

LED XOB 6 mm
FWHM / FWTM 24.0° / 44.0°
Efficiency 94 %
Peak intensity 4.4 cd/lm
LEDs/each optic 1
Light colour White
Required components:
F15255_HEKLA-SOCKET-C

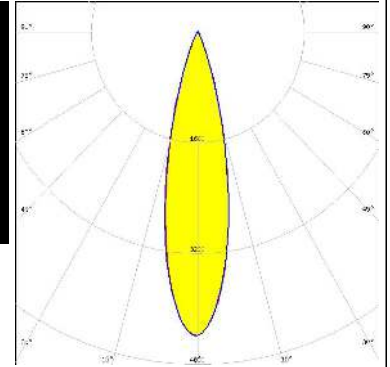
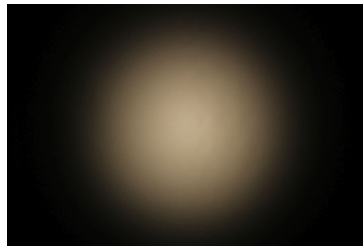





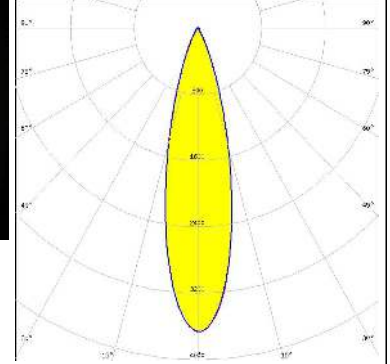

XICATO

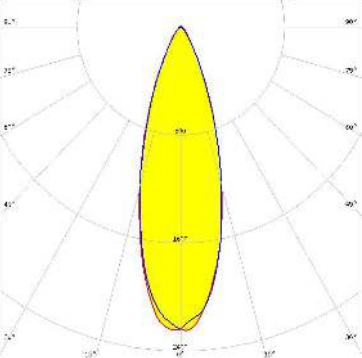
LED XOB 9.8 mm
FWHM / FWTM 26.0° / 48.0°
Efficiency 94 %
Peak intensity 3.7 cd/lm
LEDs/each optic 1
Light colour White
Required components:
F15255_HEKLA-SOCKET-C

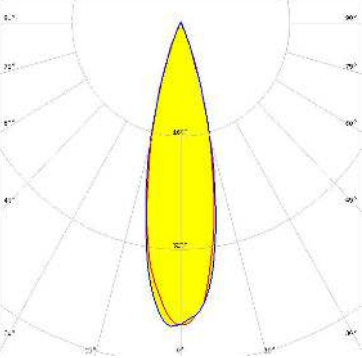

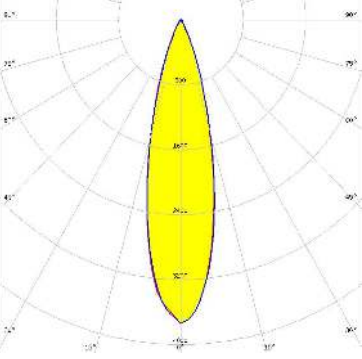
OPTICAL RESULTS (SIMULATED):

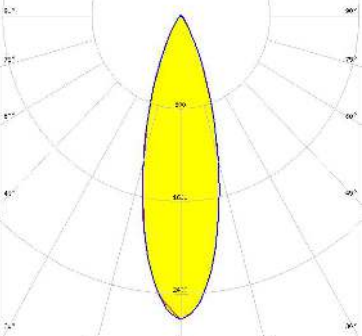
<p></p> <p>LED V13 Gen 8 FWHM / FWTM 32.0° / 61.0° Efficiency 90 % Peak intensity 2.3 cd/lm LEDs/each optic 1 Light colour White Required components: F15859_HEKLA-SOCKET-I</p>	
<p></p> <p>LED V4 HD Gen 7 FWHM / FWTM 26.0° / 44.0° Efficiency 93 % Peak intensity 4.3 cd/lm LEDs/each optic 1 Light colour White Required components: F15253_HEKLA-SOCKET-A</p>	
<p></p> <p>LED V9 HD Gen7 FWHM / FWTM 26.0° / 48.0° Efficiency 93 % Peak intensity 3.7 cd/lm LEDs/each optic 1 Light colour White Required components: F15859_HEKLA-SOCKET-I</p>	
<p></p> <p>LED Vero SE 10 FWHM / FWTM 26.0° / 48.0° Efficiency 93 % Peak intensity 3.7 cd/lm LEDs/each optic 1 Light colour White Required components:</p>	

OPTICAL RESULTS (SIMULATED):

CITIZEN

LED CLL02x/CLU02x (LES10)
 FWHM / FWTM 26.0° / 49.0°
 Efficiency 91 %
 Peak intensity 3.7 cd/lm
 LEDs/each optic 1
 Light colour White
 Required components:
 F15255_HEKLA-SOCKET-C

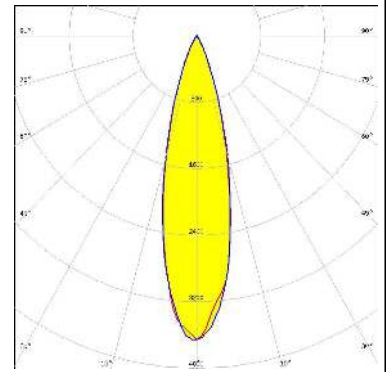

CITIZEN

LED CLU700/701/702/703
 FWHM / FWTM 26.0° / 45.0°
 Efficiency 92 %
 Peak intensity 4.2 cd/lm
 LEDs/each optic 1
 Light colour White
 Required components:
 F15255_HEKLA-SOCKET-C

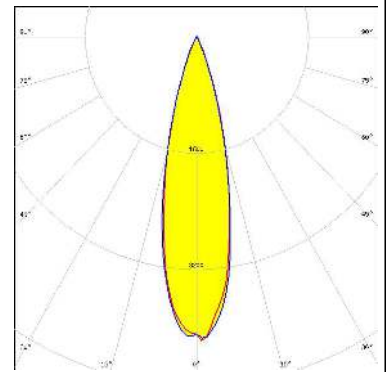

CITIZEN

LED CLU710/711
 FWHM / FWTM 26.0° / 48.0°
 Efficiency 91 %
 Peak intensity 3.8 cd/lm
 LEDs/each optic 1
 Light colour White
 Required components:
 F15859_HEKLA-SOCKET-I

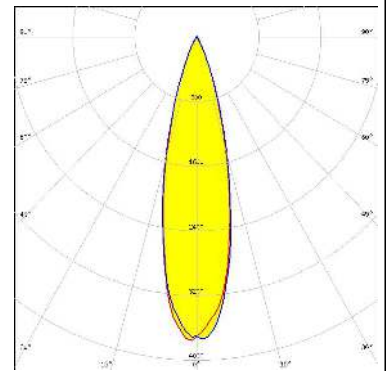

CITIZEN

LED CLU712/713
 FWHM / FWTM 28.0° / 50.0°
 Efficiency 94 %
 Peak intensity 3.5 cd/lm
 LEDs/each optic 1
 Light colour White
 Required components:
 F17438_HEKLA-G2-I

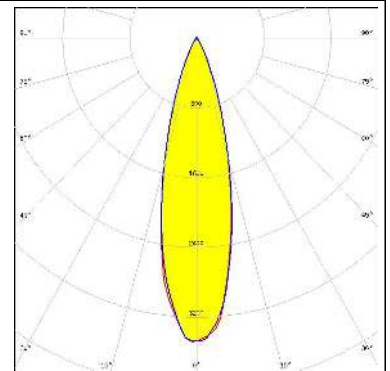

OPTICAL RESULTS (SIMULATED):

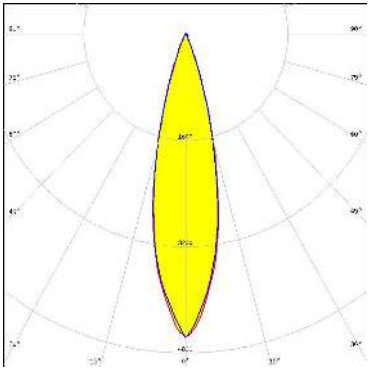
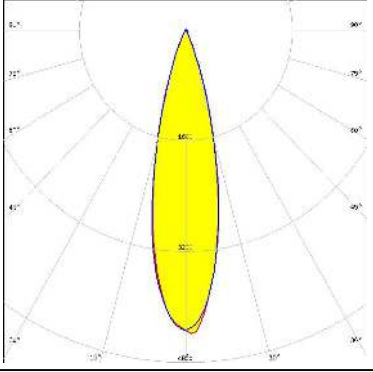
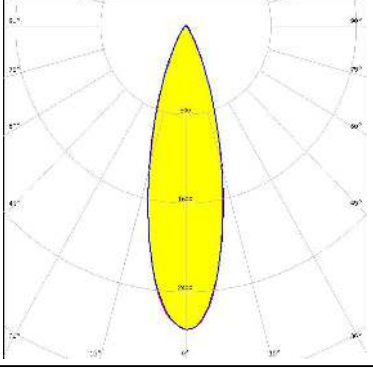
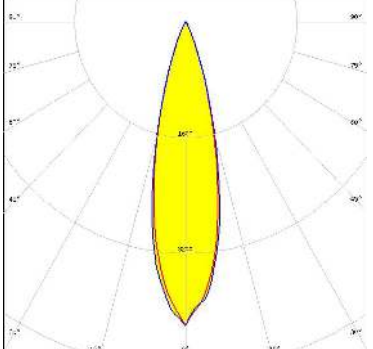
<p>CREE ⇄ LED</p> <p>LED: CHA0304 FWHM / FWTM: 25.0° / 42.0° Efficiency: 94 % Peak intensity: 4.6 cd/lm LEDs/each optic: 1 Light colour: White Required components: F17435_HEKLA-G2-C</p>	
<p>CREE ⇄ LED</p> <p>LED: CHA0410 FWHM / FWTM: 26.0° / 44.0° Efficiency: 94 % Peak intensity: 4.4 cd/lm LEDs/each optic: 1 Light colour: White Required components: F17435_HEKLA-G2-C</p>	
<p>CREE ⇄ LED</p> <p>LED: CMA1825 FWHM / FWTM: 30.0° / 56.0° Efficiency: 91 % Peak intensity: 2.7 cd/lm LEDs/each optic: 1 Light colour: White Required components: F15254_HEKLA-SOCKET-B</p>	
<p>CREE ⇄ LED</p> <p>LED: CXA/B 13xx FWHM / FWTM: 25.0° / 45.0° Efficiency: 91 % Peak intensity: 4.2 cd/lm LEDs/each optic: 1 Light colour: White Required components: F15956_HEKLA-SOCKET-J</p>	

OPTICAL RESULTS (SIMULATED):

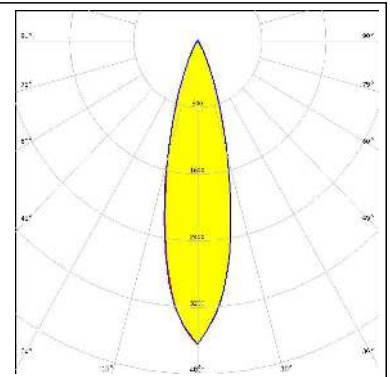
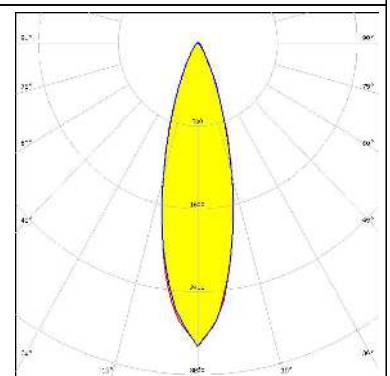
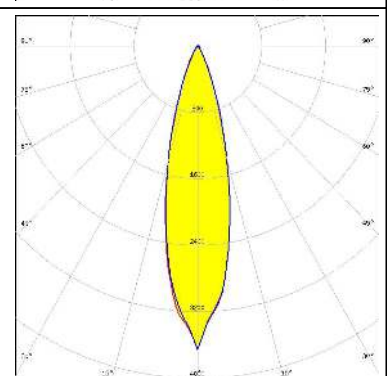
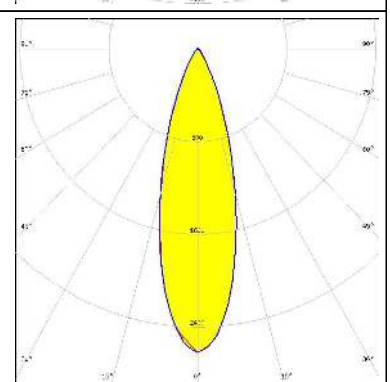
<p>CREE LED</p> <p>LED: CXA/B 15xx FWHM / FWTM: 26.0° / 49.0° Efficiency: 92 % Peak intensity: 3.6 cd/lm LEDs/each optic: 1 Light colour: White Required components: F15256_HEKLA-SOCKET-D</p>	
<p>CREE LED</p> <p>LED: CXA/B 1816 & CXA/B 1820 & CXA 1850 FWHM / FWTM: 28.0° / 55.0° Efficiency: 94 % Peak intensity: 2.9 cd/lm LEDs/each optic: 1 Light colour: White Required components: F15254_HEKLA-SOCKET-B</p>	
<p>LUMILEDS</p> <p>LED: LUXEON CoB 1202/1203 FWHM / FWTM: 26.0° / 50.0° Efficiency: 92 % Peak intensity: 3.7 cd/lm LEDs/each optic: 1 Light colour: White Required components: F17437_HEKLA-G2-H</p>	
<p>LUMILEDS</p> <p>LED: LUXEON CoB 1202s FWHM / FWTM: 26.0° / 48.0° Efficiency: 95 % Peak intensity: 3.8 cd/lm LEDs/each optic: 1 Light colour: White Required components:</p>	

OPTICAL RESULTS (SIMULATED):

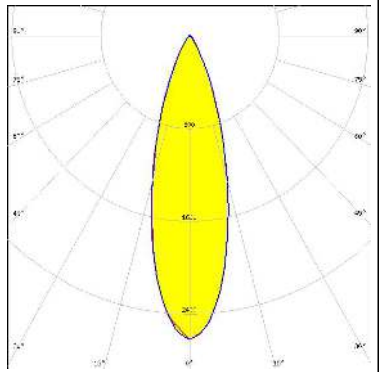
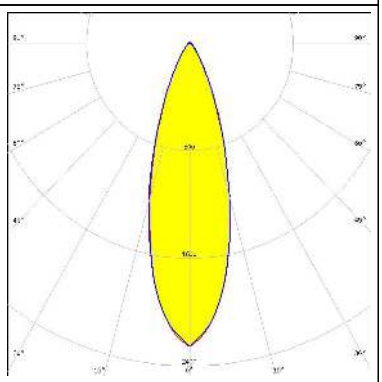
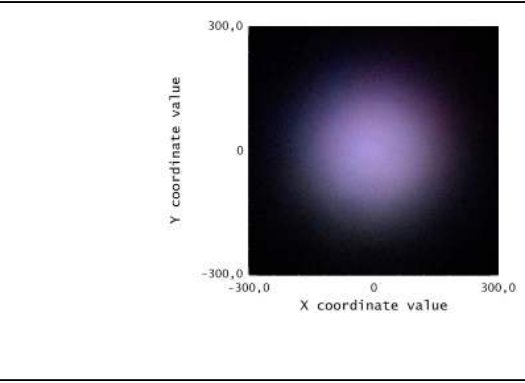
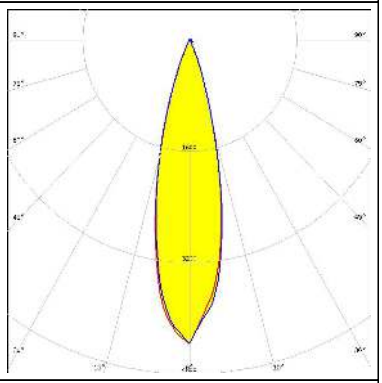
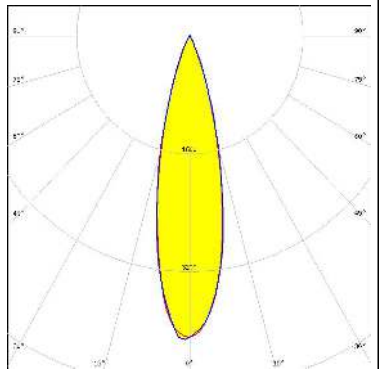
<p>LUMILEDS</p> <p>LED LUXEON CoB 1204/1205</p> <p>FWHM / FWTM 30.0° / 58.0°</p> <p>Efficiency 91 %</p> <p>Peak intensity 2.6 cd/lm</p> <p>LEDs/each optic 1</p> <p>Light colour White</p> <p>Required components:</p>		
<p>LUMILEDS</p> <p>LED LUXEON CoB 1208</p> <p>FWHM / FWTM 32.0° / 60.0°</p> <p>Efficiency 88 %</p> <p>Peak intensity 2.3 cd/lm</p> <p>LEDs/each optic 1</p> <p>Light colour White</p> <p>Required components:</p>		
<p>LUMILEDS</p> <p>LED LUXEON Rubix</p> <p>FWHM / FWTM 25.0° / 43.0°</p> <p>Efficiency 94 %</p> <p>Peak intensity 4.4 cd/lm</p> <p>LEDs/each optic 4</p> <p>Light colour RGBW</p> <p>Required components:</p>		
<p>NICHIA</p> <p>LED COB S-Type (LES 6)</p> <p>FWHM / FWTM 26.0° / 46.0°</p> <p>Efficiency 92 %</p> <p>Peak intensity 4.1 cd/lm</p> <p>LEDs/each optic 1</p> <p>Light colour White</p> <p>Required components: F15848_HEKLA-SOCKET-G</p>		

OPTICAL RESULTS (SIMULATED):

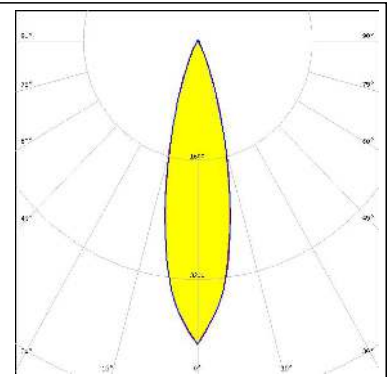
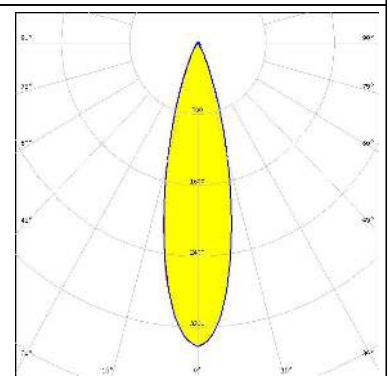
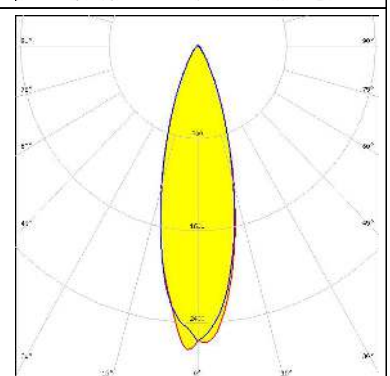
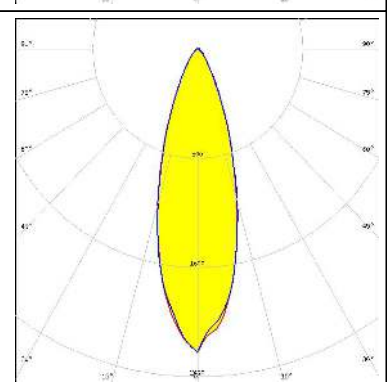
<p>NICHIA</p> <p>LED COB S-Type (LES 7)</p> <p>FWHM / FWTM 26.0° / 46.0°</p> <p>Efficiency 94 %</p> <p>Peak intensity 4.1 cd/lm</p> <p>LEDs/each optic 1</p> <p>Light colour White</p> <p>Required components: F15848_HEKLA-SOCKET-G</p>	
<p>NICHIA</p> <p>LED NFSWE11A</p> <p>FWHM / FWTM 26.0° / 48.0°</p> <p>Efficiency 87 %</p> <p>Peak intensity 3.4 cd/lm</p> <p>LEDs/each optic 30</p> <p>Light colour White</p> <p>Required components: C16142_HEKLA-SOCKET-K</p>	
<p>PHILIPS</p> <p>LED Fortimo SLM L13 CoB</p> <p>FWHM / FWTM 29.0° / 56.0°</p> <p>Efficiency 91 %</p> <p>Peak intensity 2.6 cd/lm</p> <p>LEDs/each optic 1</p> <p>Light colour White</p> <p>Required components: Bender Wirth: 632a Hekla XL</p>	
<p>PHILIPS</p> <p>LED Fortimo SLM L15 CoB</p> <p>FWHM / FWTM 32.0° / 62.0°</p> <p>Efficiency 89 %</p> <p>Peak intensity 2.2 cd/lm</p> <p>LEDs/each optic 1</p> <p>Light colour White</p> <p>Required components: Bender Wirth: 632a Hekla XL</p>	

OPTICAL RESULTS (SIMULATED):

SAMSUNG

LED LC010C
 FWHM / FWTM 26.0° / 46.0°
 Efficiency 92 %
 Peak intensity 4.1 cd/lm
 LEDs/each optic 1
 Light colour White
 Required components:
 F15848_HEKLA-SOCKET-G

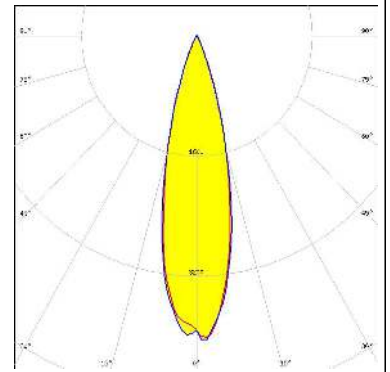

SAMSUNG

LED LC020C
 FWHM / FWTM 26.0° / 46.0°
 Efficiency 93 %
 Peak intensity 4.1 cd/lm
 LEDs/each optic 1
 Light colour White
 Required components:
 F17438_HEKLA-G2-I

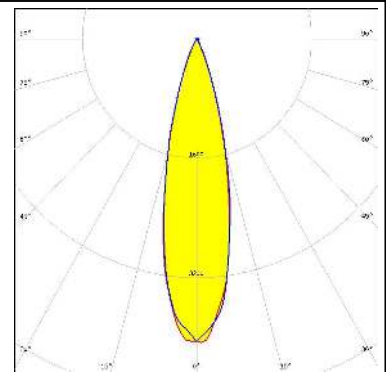

XICATO

LED XTM - 9mm LES
 FWHM / FWTM 26.0° / 49.0°
 Efficiency 93 %
 Peak intensity 3.6 cd/lm
 LEDs/each optic 1
 Light colour White
 Required components:
 C15743_XTM-ADAPTER-50-B

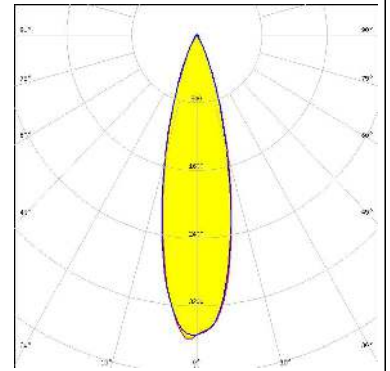

GENERAL INFORMATION:

NOTE: The typical beam angle will be changed by different color, chip size and chip position tolerance. The typical total beam angle is the full angle measured where the luminous intensity is half of the peak value.

Due to use of high power COB's with this product, special attention to proper thermal design is highly recommended. LEDiL has no liability for direct, indirect or consecutive damages arising from the LEDiL products being used outside of the recommended temperature range.

MATERIALS:

As part of our continuous research and improvement processes, and to ensure the best possible quality and availability of our products, LEDiL reserves the right to change material grades without notice.

PRODUCT DATA USER AGREEMENT AND DISCLAIMER:

The measured data in the provided downloadable LEDiL Product Datasheets and Mechanical 2D-Drawings is rounded and provided as reference for planning. LEDiL Oy's optical specifications have been verified by conducting performance testing of the products in accordance with the company's quality system. The reported data are averaged results of multiple measurements with typical variation. LEDiL Oy reserves the right to without prior notification make changes and improvements to its products.

LEDiL Oy assumes neither warranty, nor guarantee nor any other liability of any kind for the contents and correctness of the provided data. The provided data has been generated with highest diligence but the provided data may in reality not represent the complete possible variation range of all intrinsic parameters. Therefore, in certain cases a deviation from the provided data could occur.

LEDiL Oy reserves the right to undertake technical changes of its products without further notification which could lead to changes in the provided data. LEDiL Oy assumes no liability of any kind for the possible deviation from any provided data or any other damage resulting from the usage of the provided data.

The user agrees to this disclaimer and user agreement with the download or usage of the provided files.

LEDiL Oy

Joensuunkatu 13
FI-24240 SALO
Finland

LEDiL Inc.

228 West Page Street
Suite D
Sycamore IL 60178
USA

Ledil Optics Technology (Shenzhen) Co., Ltd.

405 , Block B
Casic Motor Building
Shenzhen 518057
P.R.CHINA

Local sales and technical support

[www.ledil.com/
where_to_buy](http://www.ledil.com/where_to_buy)

Shipping locations

Salo, Finland
Hong Kong, China

Distribution Partners

[www.ledil.com/
where_to_buy](http://www.ledil.com/where_to_buy)