

ME005-Series Power Modules: 39.5 Vdc to 60 Vdc Input; 5 W



The ME005-Series Power Modules use advanced, surface-mount technology and deliver high-quality, compact, dc-dc conversion at an economical price.

Applications

- Communication equipment
- Computer equipment
- Digital circuitry
- Distributed power architectures

Description

The ME005-Series Power Modules are dc-dc converters that operate over an input voltage range of 39.5 Vdc to 60 Vdc and provide precisely regulated dc outputs. The outputs are fully isolated from the inputs, allowing versatile polarity configurations and grounding connections. The modules have maximum power ratings of 5 W at typical full-load efficiencies of 80% to 83% depending on the code.

The modules are encapsulated in nonconductive cases that mount on PC boards. In a natural convection environment, the modules are rated to full load at 85 °C with no heat sinking or external filtering.

* *UL* is a registered trademark of Underwriters Laboratories, Inc.

† *CSA* is a registered trademark of Canadian Standards Association.

‡ *TUV* is a registered trademark of Technischer Überwachungs-Verein.

Features

- Small size: 50.8 mm x 27.9 mm x 11.7 mm (2.00 in. x 1.10 in. x 0.46 in.)
- Operating ambient temperature range: -40 °C to +85 °C
- High reliability
- Input-to-output isolation
- No external filtering required
- Load regulation: 0.15% max (ME005A, B, C, N)
- Line regulation: 0.05% max (ME005A, B, C, N)
- Overcurrent protection
- Output overvoltage protection
- PC board mountable
- *UL** 1950 Recognized, *CSA*† C22.2 No. 950-95 Certified, VDE 0805 (EN60950, IEC950) and *TUV*‡ Licensed
- Within FCC Class B requirements for radiated emissions

Options

- Long pins: 5.8 mm (0.230 in.)

Absolute Maximum Ratings

Stresses in excess of the absolute maximum ratings can cause permanent damage to the device. These are absolute stress ratings only. Functional operation of the device is not implied at these or any other conditions in excess of those given in the operations sections of the data sheet. Exposure to absolute maximum ratings for extended periods can adversely affect device reliability.

Parameter	Symbol	Min	Max	Unit
Input Voltage (continuous)	V_I	—	60	Vdc
Operating Ambient Temperature (natural convection)	T_A	-40	85	°C
Storage Temperature	T_{stg}	-40	100	°C
I/O Isolation Voltage	—	—	500	Vdc

Electrical Specifications

Unless otherwise indicated, specifications apply over all operating input voltage, resistive load, and temperature conditions.

Table 1. Input Specifications

Parameter	Symbol	Min	Typ	Max	Unit
Operating Input Voltage	V_I	39.5	48	60	Vdc
Maximum Input Current ($V_I = 0$ V to 60 V; $I_O = I_{O, max}$; see Figures 1—5.)	$I_{I, max}$	—	—	600	mA
Inrush Transient	i^2t	—	0.3	1.0	A ² s
Input Reflected-ripple Current, Peak-to-peak (5 Hz to 20 MHz, 12 μ H source impedance, $T_A = 25$ °C; see Figure 31 and Design Considerations section.)	I_I	—	30	—	mA _{p-p}
Input Ripple Rejection (120 Hz)	—	—	53	—	dB

Fusing Considerations

CAUTION: This power module is not internally fused. An input line fuse must always be used.

This encapsulated power module can be used in a wide variety of applications, ranging from simple stand-alone operation to an integrated part of a sophisticated power architecture. To preserve maximum flexibility, internal fusing is not included; however, to achieve maximum safety and system protection, always use an input line fuse. The safety agencies require a normal-blow fuse with a maximum rating of 5 A in series with the input (see Safety Considerations section). Based on the information provided in this data sheet on inrush energy and maximum dc input current, the same type of fuse with a lower rating can be used. However, for *UL* recognition, the dc rating of the fuse must not exceed 5 A. Refer to the fuse manufacturer's data for further information.

Electrical Specifications (continued)

Table 2. Output Specifications

Parameter	Device	Symbol	Min	Typ	Max	Unit	
Output Voltage Set Point ($V_I = 48\text{ V}$; $I_O = I_{O, \text{max}}$; $T_A = 25\text{ }^\circ\text{C}$)	ME005A	$V_{O, \text{set}}$	4.85	5.0	5.20	Vdc	
	ME005N	$V_{O, \text{set}}$	5.10	5.20	5.30	Vdc	
	ME005B	$V_{O, \text{set}}$	11.52	12.0	12.48	Vdc	
	ME005C	$V_{O, \text{set}}$	14.4	15.0	15.6	Vdc	
	ME005BK	$V_{O1, \text{set}}$	11.4	12.0	12.6	Vdc	
		$V_{O2, \text{set}}$	-11.4	-12.0	-12.6	Vdc	
	ME005CL	$V_{O1, \text{set}}$	14.25	15.0	15.75	Vdc	
		$V_{O2, \text{set}}$	-14.25	-15.0	-15.75	Vdc	
Output Voltage (Over all operating input voltage, resistive load, and temperature conditions until end of life. See Figure 33. See Figures 9—12 for cross regulation on dual outputs.)	ME005A	V_O	4.80	—	5.25	Vdc	
	ME005N	V_O	5.05	—	5.35	Vdc	
	ME005B	V_O	11.4	—	12.6	Vdc	
	ME005C	V_O	14.25	—	15.75	Vdc	
	ME005BK	V_{O1}	10.08	—	13.2	Vdc	
		V_{O2}	-10.08	—	-13.2	Vdc	
	ME005CL	V_{O1}	13.5	—	16.5	Vdc	
		V_{O2}	-13.5	—	-16.5	Vdc	
Output Regulation: Line ($V_I = 39.5\text{ Vdc}$ to 60 Vdc) Load ($I_O = I_{O, \text{min}}$ to $I_{O, \text{max}}$) Temperature ($T_A = -40\text{ }^\circ\text{C}$ to $+85\text{ }^\circ\text{C}$; see Figures 6—8.)	ME005A, B, C, N	—	—	0.01	0.05	% V_O	
	ME005A, B, C, N	—	—	0.05	0.15	% V_O	
	ME005A, N	—	—	15	70	mV	
	ME005B	—	—	40	150	mV	
	ME005C	—	—	45	190	mV	
Output Ripple and Noise Voltage (With $0.1\text{ }\mu\text{F}$ ceramic bypass capacitor on output; see Figure 32.): RMS Peak-to-peak (5 Hz to 20 MHz)	ME005A, N	—	—	—	15	mVrms	
	ME005B, C	—	—	—	25	mVrms	
	ME005BK, CL	—	—	—	80	mVrms	
	ME005A, N	—	—	—	50	mVp-p	
	ME005B, C	—	—	—	100	mVp-p	
	ME005BK, CL	—	—	—	250	mVp-p	
Output Current (At $I_O < I_{O, \text{min}}$, the modules may exceed output ripple specifications and dual-output modules may exceed specified output voltages.)	ME005A	I_O	0.02	—	1.0	A	
	ME005N	I_O	0.02	—	0.96	A	
	ME005B	I_O	0.005	—	0.42	A	
	ME005C	I_O	0.005	—	0.33	A	
	ME005BK	I_{O1}	0.02	—	0.21	A	
		I_{O2}	0.02	—	0.21	A	
	ME005CL	I_{O1}	0.017	—	0.17	A	
		I_{O2}	0.017	—	0.17	A	
Output Current-limit Inception (See Figures 13—19.): $V_O = 4.5\text{ V}$ $V_O = 4.68\text{ V}$ $V_O = 10.8\text{ V}$ $V_O = 13.5\text{ V}$ V_{O1} or $V_{O2} = 10.2\text{ V}$ V_{O1} or $V_{O2} = 12.75\text{ V}$	ME005A	I_O	—	1.6	2.5	A	
	ME005N	I_O	—	1.6	2.5	A	
	ME005B	I_O	—	0.8	1.4	A	
	ME005C	I_O	—	0.7	1.3	A	
	ME005BK	I_O	—	—	0.8	1.4	A
		I_O	—	—	0.7	1.3	A
	ME005CL	I_O	—	—	0.7	1.3	A

Electrical Specifications (continued)

Table 2. Output Specifications (continued)

Parameter	Device	Symbol	Min	Typ	Max	Unit
Output Current Limit (See Figures 13—19.): V _o = 1.0 V V _o = 1.0 V V _{o1} or V _{o2} = 1.0 V	ME005A, N ME005B, C ME005BK, CL	— — —	— — —	— — —	3.0 2.0 2.0	A A A
Output Short-circuit Current (V _o = 250 mV; see Figures 13—19.)	ME005A, N ME005B, C, BK, CL	— —	— —	1.5 1.0	— —	A A
Efficiency (V _i = 48 V; I _o = I _{o, max} ; T _A = 25 °C; see Figures 20—24, 33, and 34.)	ME005A, N ME005B, C ME005BK, CL	η η η	77 80 79	80 83 82	— — —	% % %
Dynamic Response ($\dot{I}_o/\dot{V}_t = 1 \text{ A}/10 \mu\text{s}$, V _i = 48 V, T _A = 25 °C; for ME005BK and CL applies to V _{o1} and V _{o2} at I _o = I _{o, max}): Load Change from I _o = 50% to 75% of I _{o, max} (See Figures 25—27.): Peak Deviation Settling Time (V _o < 10% peak deviation) Load Change from I _o = 50% to 25% of I _{o, max} (See Figures 28—30.): Peak Deviation Settling Time (V _o < 10% of peak deviation)	ME005A, N ME005B, C ME005BK, CL ME005A, B, C, N ME005BK, CL ME005A, N ME005B ME005C ME005BK, CL ME005A, B, C, N ME005BK, CL	— — — — — — — — — — —	— — — — — — — — — — —	80 70 50 3.5 5.0 80 70 60 50 3.5 5.0	— — — — — — — — — — —	mV mV mV ms ms mV mV mV mV ms ms

Electrical Specifications (continued)

Table 3. Isolation Specifications

Parameter	Device	Min	Typ	Max	Unit
Isolation Capacitance	All	—	1200	—	pF
Isolation Resistance	All	10	—	—	M ^{3/4}

General Specifications

Parameter	Device	Min	Typ	Max	Unit
Calculated MTBF (I _o = 80% of I _{o, max} ; T _c = 40 °C)	All	7,000,000			hours
Weight	All	—	—	28 (1.0)	g (oz.)

Feature Specifications

Unless otherwise indicated, specifications apply over all operating input voltage, resistive load, and temperature conditions. See Feature Descriptions for further information.

Parameter	Device	Symbol	Min	Typ	Max	Unit
Output Overvoltage Protection (clamp)	ME005A, N	V _{O, clamp}	—	6.0	7.0	V
	ME005B	V _{O, clamp}	—	14	16	V
	ME005C	V _{O, clamp}	—	17	19	V
	ME005BK	V _{O1, clamp}	—	16	18	V
		V _{O2, clamp}	—	-16	-18	V
	ME005CL	V _{O1, clamp}	—	19	21	V
		V _{O2, clamp}	—	-19	-21	V

Characteristic Curves

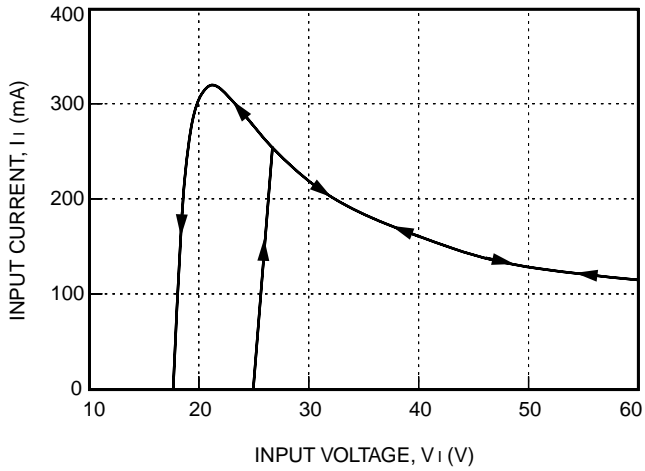

Figure 1. ME005A, N Typical Input Characteristics with $I_o = I_{o, max}$ and $T_A = 25\text{ }^\circ\text{C}$ (Arrows Indicate Hysteresis)

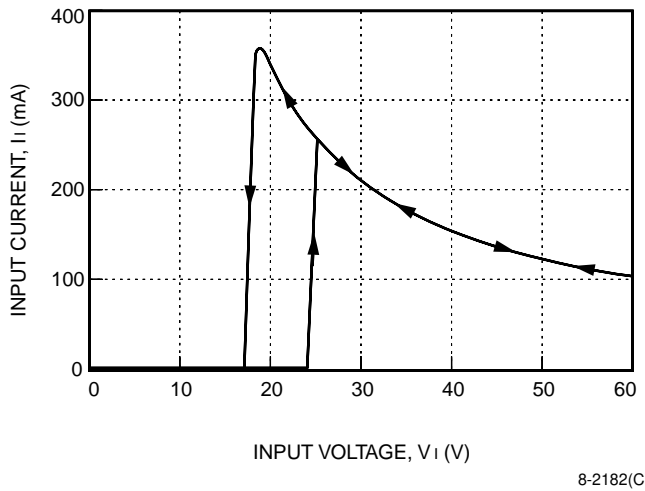

Figure 2. ME005B Typical Input Characteristics with $I_o = I_{o, max}$ and $T_A = 25\text{ }^\circ\text{C}$ (Arrows Indicate Hysteresis)

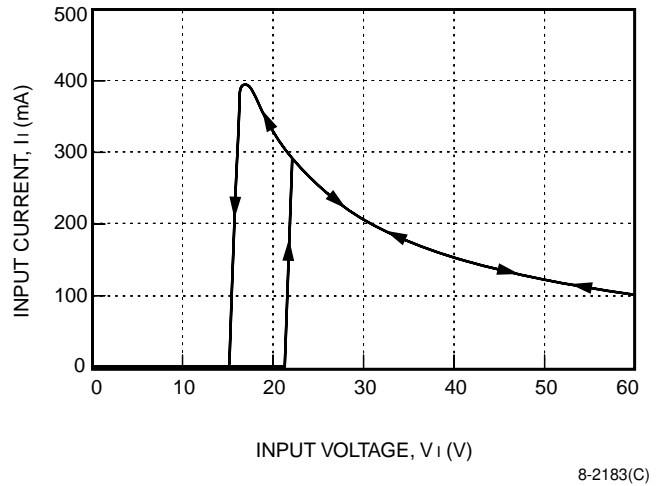

Figure 3. ME005C Typical Input Characteristics with $I_o = I_{o, max}$ and $T_A = 25\text{ }^\circ\text{C}$ (Arrows Indicate Hysteresis)

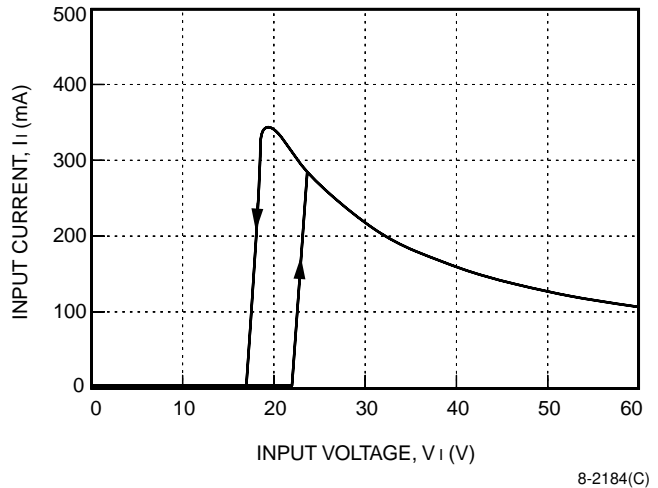

Figure 4. ME005BK Typical Input Characteristics with $I_o = I_{o, max}$ and $T_A = 25\text{ }^\circ\text{C}$ (Arrows Indicate Hysteresis)

Characteristic Curves (continued)

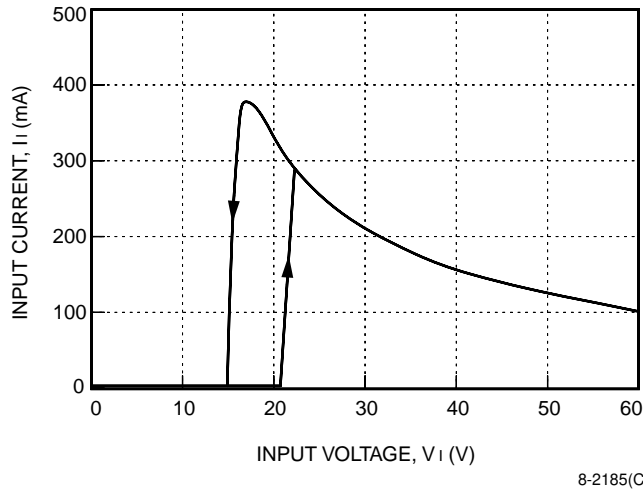

Figure 5. ME005CL Typical Input Characteristics with $I_o = I_{o,max}$ and $T_A = 25\text{ }^\circ\text{C}$ (Arrows Indicate Hysteresis)

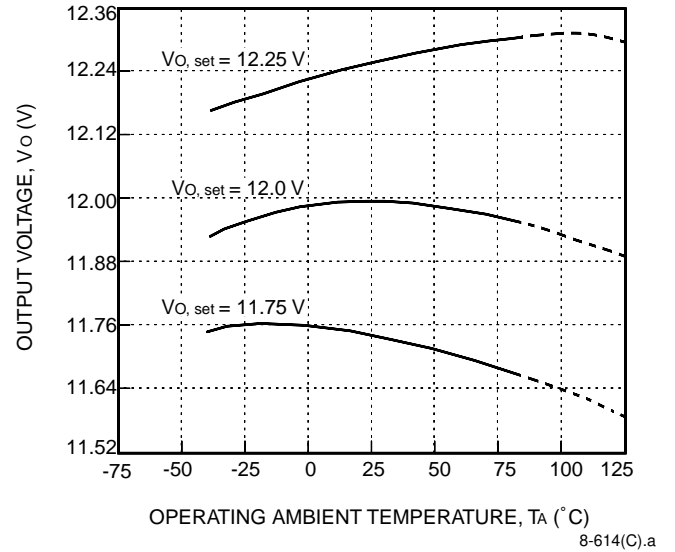

Figure 7. ME005B Typical Output Voltage Variations over Operating Ambient Temperature Range

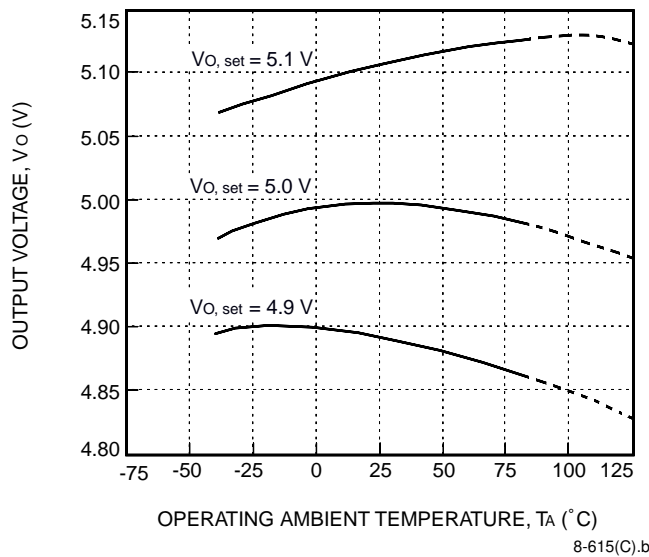

Figure 6. ME005A Typical Output Voltage Variations over Operating Ambient Temperature Range (ME005N Variations Are Similar.)

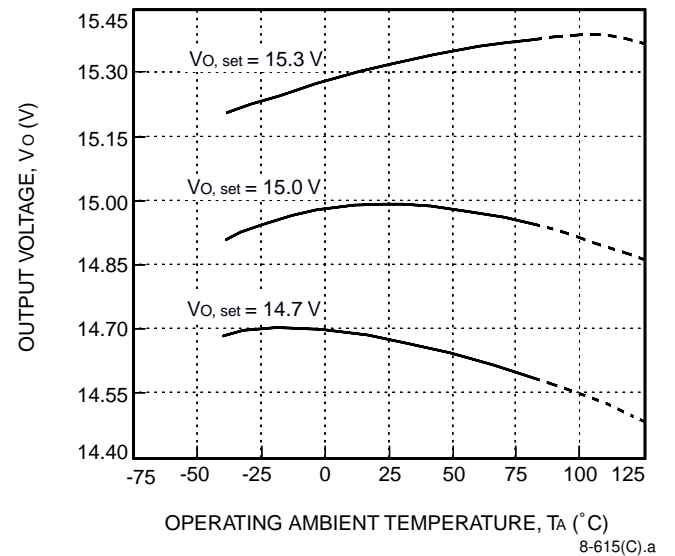

Figure 8. ME005C Typical Output Voltage Variations over Operating Ambient Temperature Range

Characteristic Curves (continued)

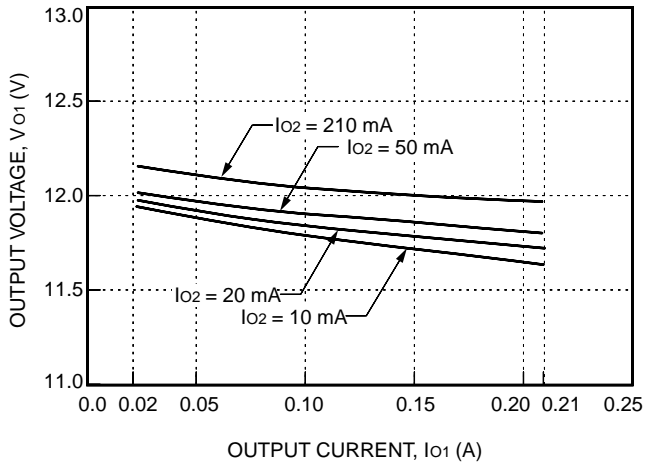

Figure 9. ME005BK Typical V_{o1} vs. I_{o1} Regulation with $V_i = 48\text{ V}$ and $T_A = 25\text{ }^\circ\text{C}$

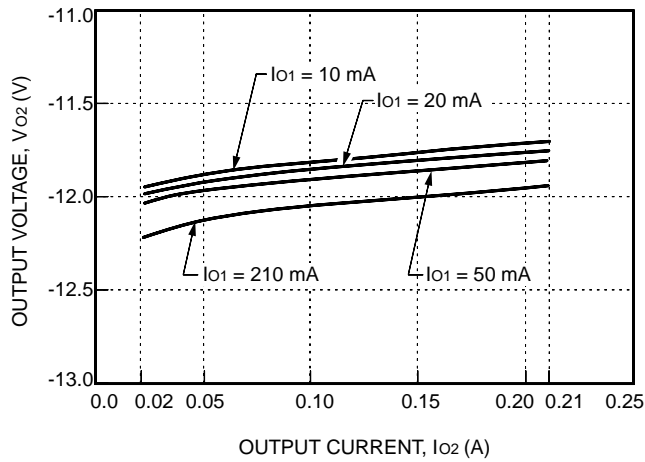

Figure 10. ME005BK Typical V_{o2} vs. I_{o2} Regulation with $V_i = 48\text{ V}$ and $T_A = 25\text{ }^\circ\text{C}$

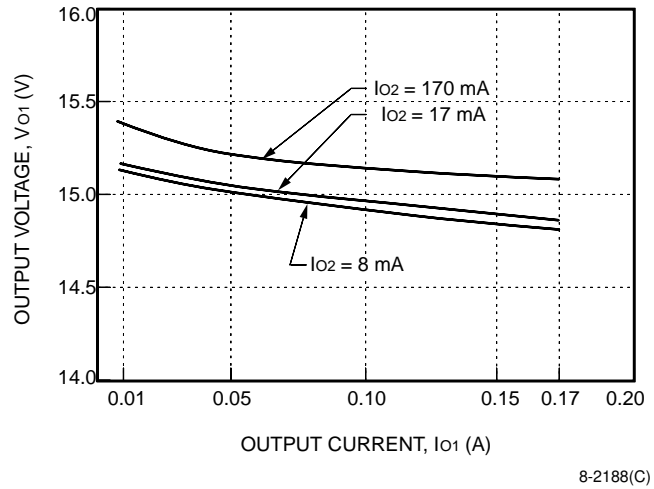

Figure 11. ME005CL Typical V_{o1} vs. I_{o1} Regulation with $V_i = 48\text{ V}$ and $T_A = 25\text{ }^\circ\text{C}$

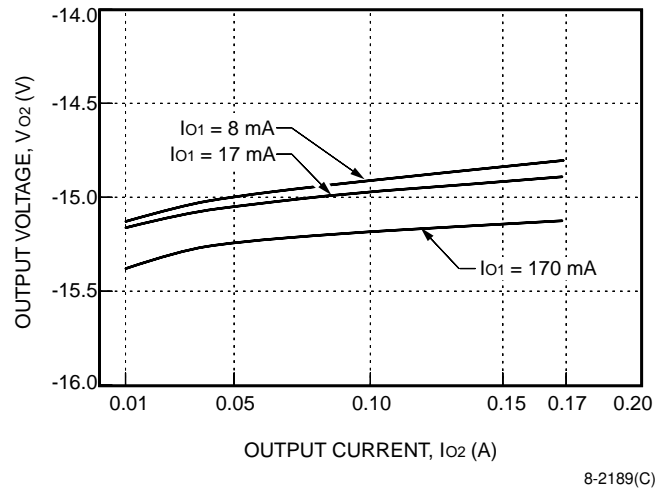
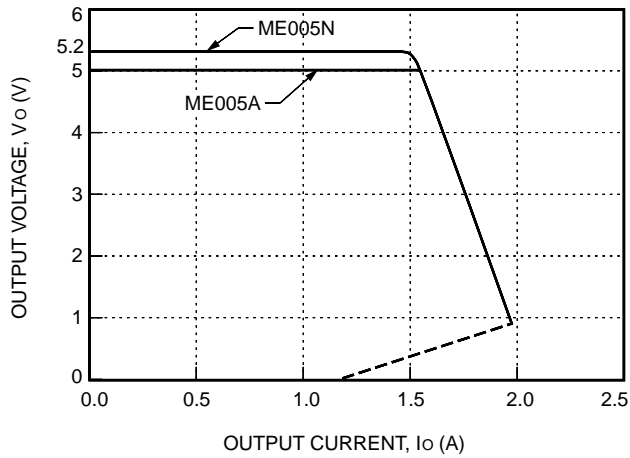

Figure 12. ME005CL Typical V_{o2} vs. I_{o2} Regulation with $V_i = 48\text{ V}$ and $T_A = 25\text{ }^\circ\text{C}$

Characteristic Curves (continued)



8-2190(C)

Figure 13. ME005A, N Typical Output Characteristics with $V_i = 48\text{ V}$ and $T_A = 25\text{ }^\circ\text{C}$

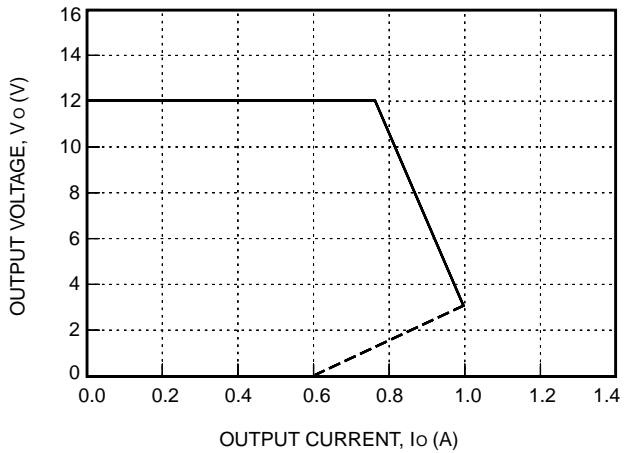

8-2191(C)

Figure 14. ME005B Typical Output Characteristics with $V_i = 48\text{ V}$ and $T_A = 25\text{ }^\circ\text{C}$

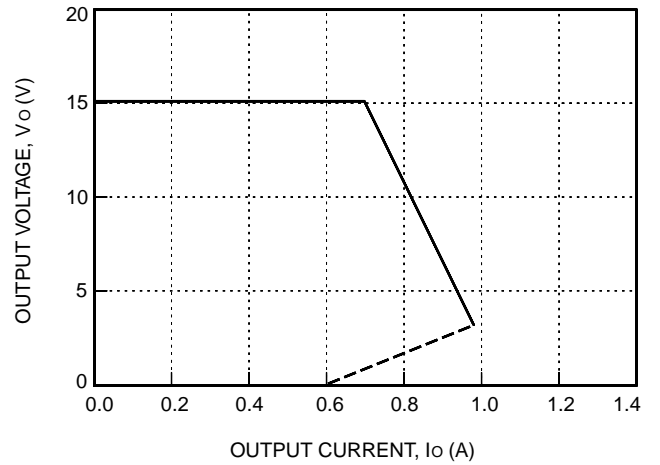

8-2192(C)

Figure 15. ME005C Typical Output Characteristics with $V_i = 48\text{ V}$ and $T_A = 25\text{ }^\circ\text{C}$

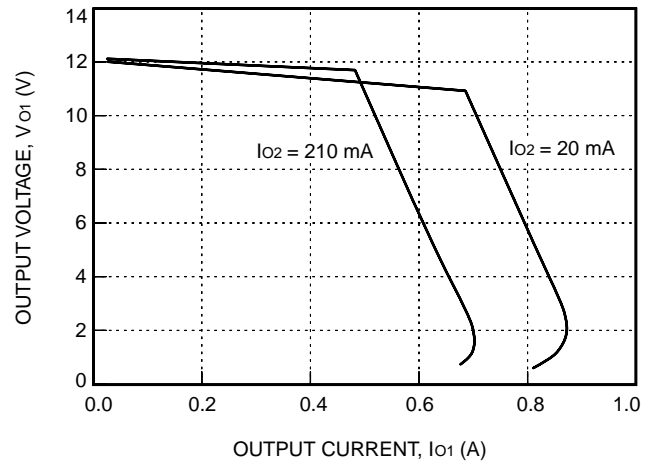

8-2193(C)

Figure 16. ME005BK Typical Output Characteristics (V_{o1} vs. I_{o1}) with $V_i = 48\text{ V}$ and $T_A = 25\text{ }^\circ\text{C}$

Characteristic Curves (continued)

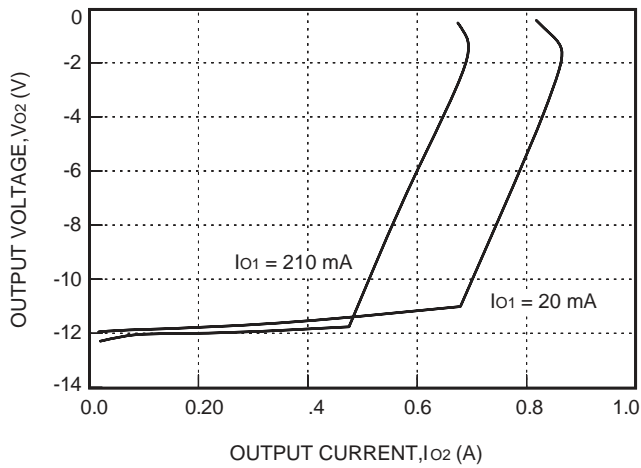

8-2194(C)

Figure 17. ME005BK Typical Output Characteristics (Vo2 vs. Io2) with Vi = 48 V and TA = 25 °C

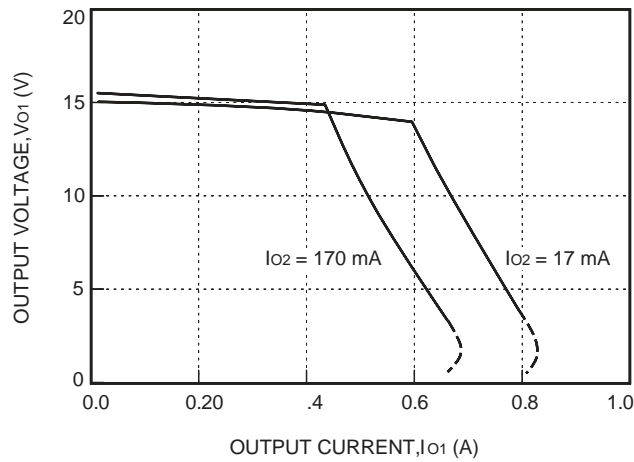

8-2195(C)

Figure 18. ME005CL Typical Output Characteristics (Vo1 vs. Io1) with Vi = 48 V and TA = 25 °C

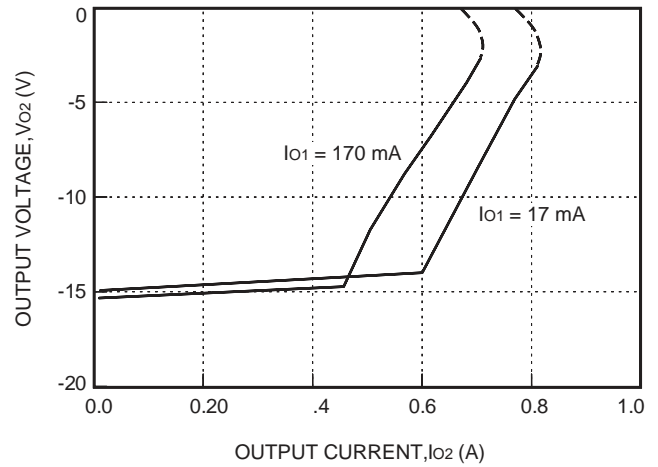

8-2196(C)

Figure 19. ME005CL Typical Output Characteristics (Vo2 vs. Io2) with Vi = 48 V and TA = 25 °C

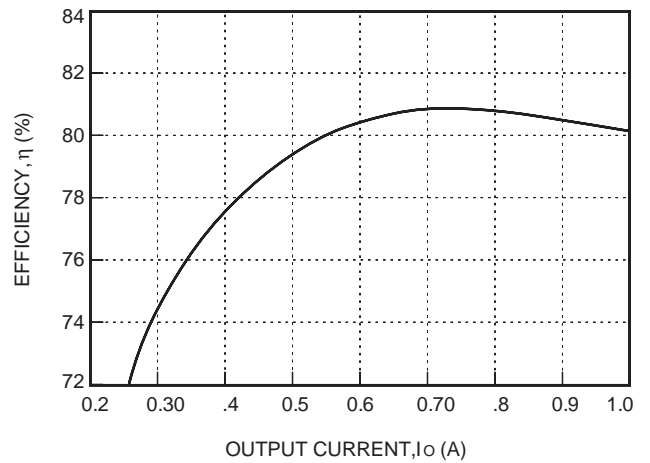

8-2197(C)

Figure 20. ME005A, N Typical Converter Efficiency as a Function of Output Current with Vi = 48 V and TA = 25 °C

Characteristic Curves (continued)

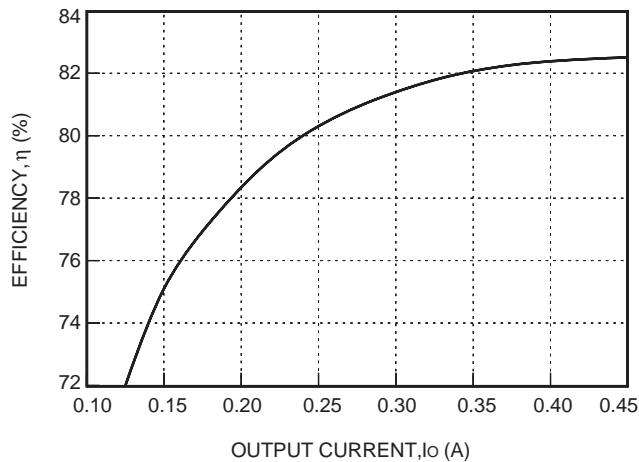

8-2198(C)

Figure 21. ME005B Typical Converter Efficiency as a Function of Output Current with $V_i = 48\text{ V}$ and $T_A = 25\text{ }^\circ\text{C}$

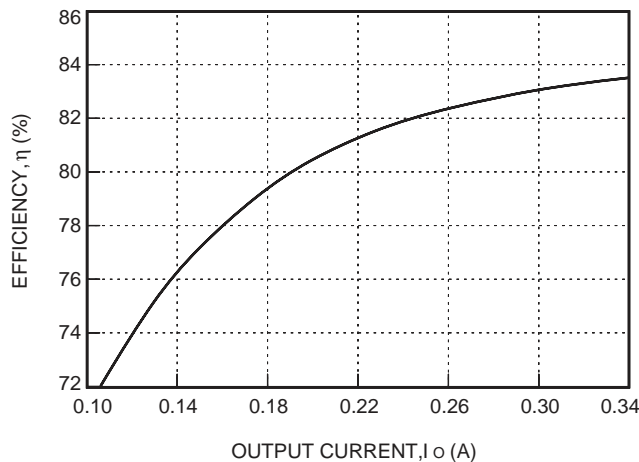

8-2199(C)

Figure 22. ME005C Typical Converter Efficiency as a Function of Output Current with $V_i = 48\text{ V}$ and $T_A = 25\text{ }^\circ\text{C}$

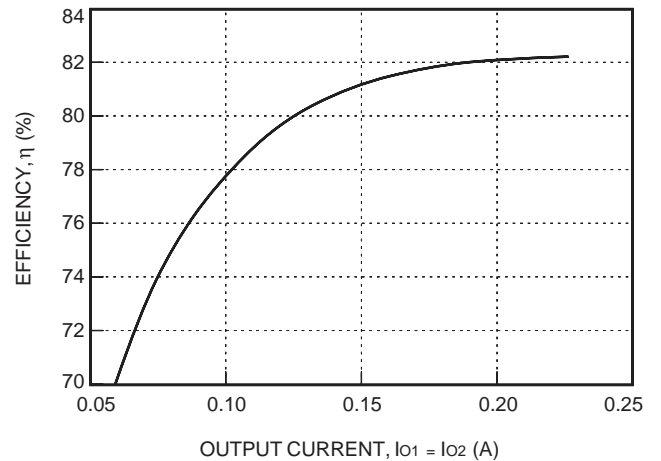

8-2200(C)

Figure 23. ME005BK Typical Converter Efficiency as a Function of Output Current with $V_i = 48\text{ V}$ and $T_A = 25\text{ }^\circ\text{C}$

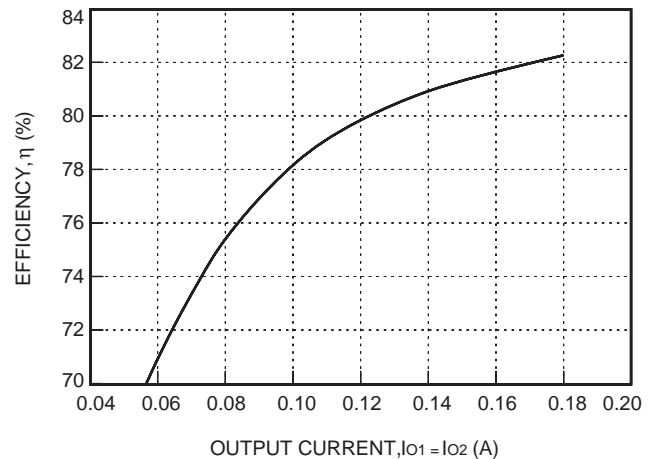

8-2201(C)

Figure 24. ME005CL Typical Converter Efficiency as a Function of Output Current with $V_i = 48\text{ V}$ and $T_A = 25\text{ }^\circ\text{C}$

Characteristic Curves (continued)

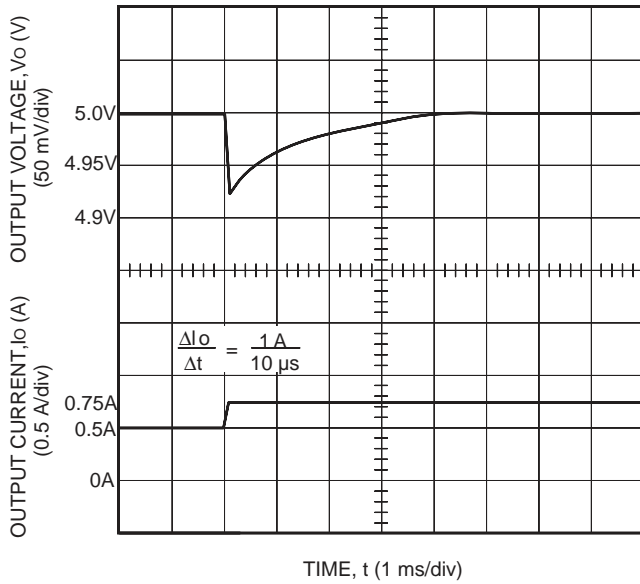

Figure 25. ME005A Typical Output Voltage Waveform for a Step Load Change from 50% to 75% of $I_{o, \text{max}}$ with $V_i = 48 \text{ V}$ and $T_A = 25 \text{ }^\circ\text{C}$ (ME005N Waveform Is Similar, but with 5.2 V Steady-State.)

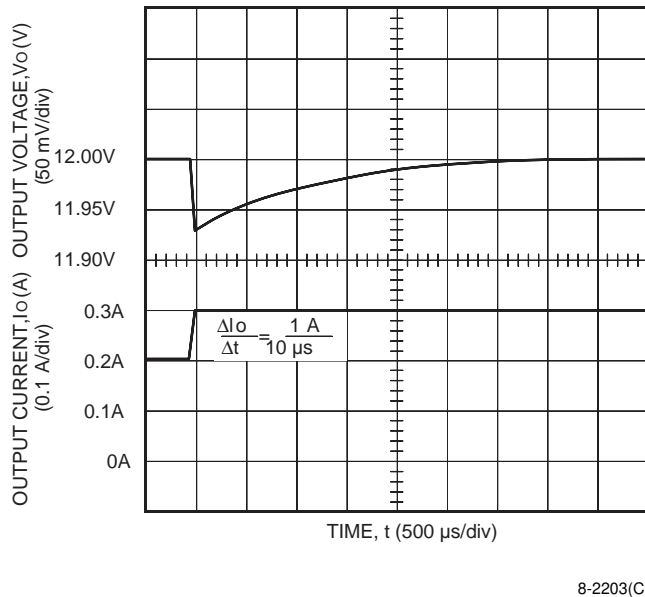

Figure 26. ME005B Typical Output Voltage Waveform for a Step Load Change from 50% to 75% of $I_{o, \text{max}}$ with $V_i = 48 \text{ V}$ and $T_A = 25 \text{ }^\circ\text{C}$

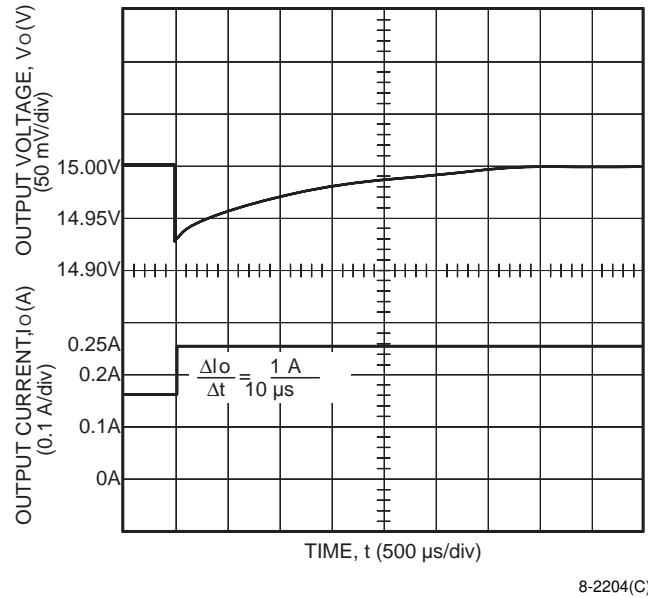

Figure 27. ME005C Typical Output Voltage Waveform for a Step Load Change from 50% to 75% of $I_{o, \text{max}}$ with $V_i = 48 \text{ V}$ and $T_A = 25 \text{ }^\circ\text{C}$

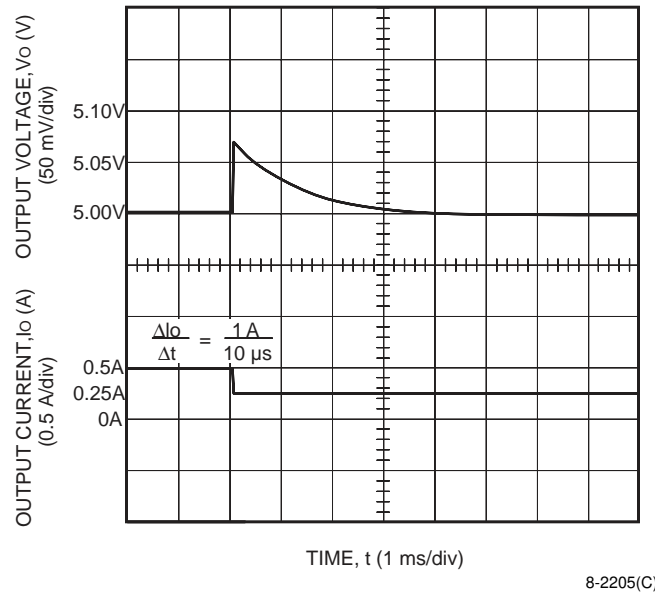

Figure 28. ME005A Typical Output Voltage Waveform for a Step Load Change from 50% to 25% of $I_{o, \text{max}}$ with $V_i = 48 \text{ V}$ and $T_A = 25 \text{ }^\circ\text{C}$ (ME005N Waveform Is Similar, but with 5.2 V Steady-State.)

Characteristic Curves (continued)

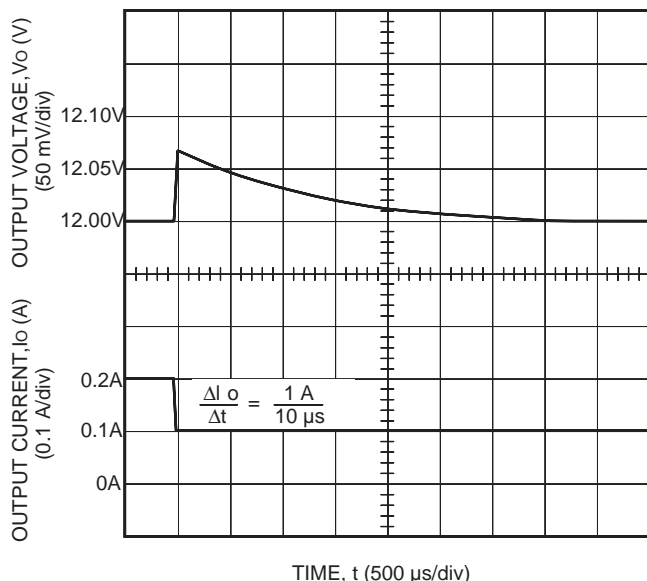

Figure 29. ME005B Typical Output Voltage Waveform for a Step Load Change from 50% to 25% of $I_{o,max}$ with $V_i = 48\text{ V}$ and $T_A = 25\text{ }^\circ\text{C}$

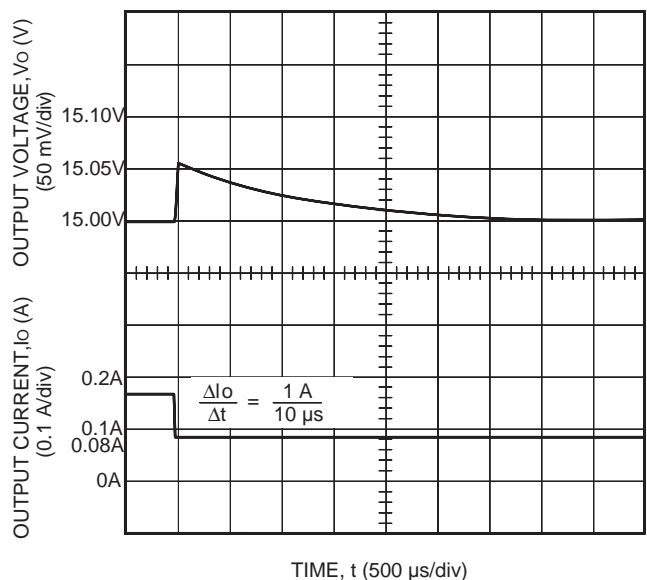
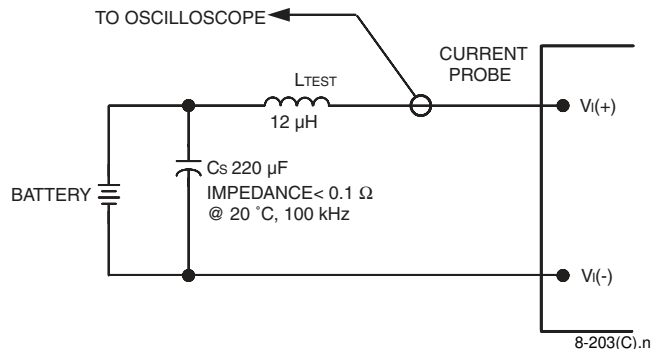

Figure 30. ME005C Typical Output Voltage Waveform for a Step Load Change from 50% to 25% of $I_{o,max}$ with $V_i = 48\text{ V}$ and $T_A = 25\text{ }^\circ\text{C}$

Test Configurations



Note: Input reflected-ripple current is measured with a simulated source impedance of $12\ \mu\text{H}$. Capacitor C_s offsets possible battery impedance. Current is measured at the input of the module.

Figure 31. Input Reflected-Ripple Test Setup

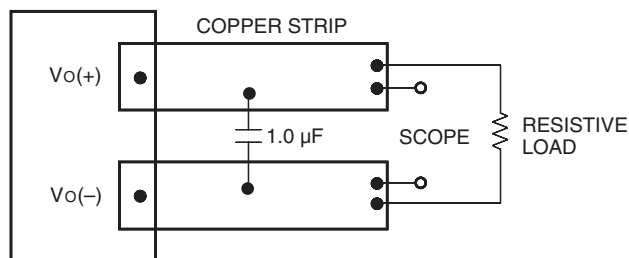

Note: Use a $0.1\ \mu\text{F}$ ceramic capacitor. Scope measurement should be made using a BNC socket. Position the load between 50 mm and 75 mm (2 in. and 3 in.) from the module.

Figure 32. Peak-to-Peak Output Noise Measurement Test Setup

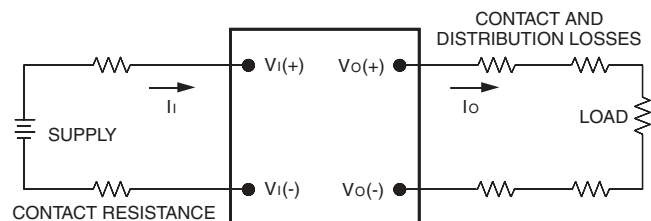

Note: All measurements are taken at the module terminals. When socketing, place Kelvin connections at module terminals to avoid measurement errors due to socket contact resistance.

$$\eta = \frac{[V_o(+)-V_o(-)] I_o}{[V_i(+)-V_i(-)] I_i} \times 100 \quad \%$$

Figure 33. ME005A, B, C, N Output Voltage and Efficiency Measurement Test Setup

Test Configurations (continued)

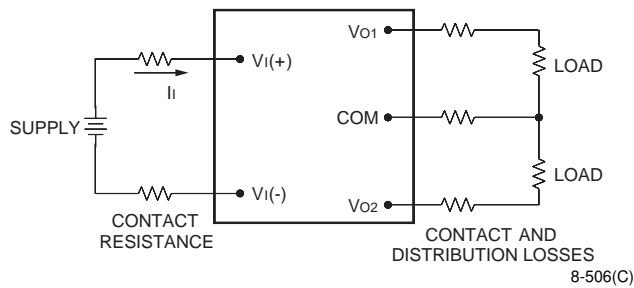

Note: All measurements are taken at the module terminals. When socketing, place Kelvin connections at module terminals to avoid measurement errors due to socket contact resistance.

$$\eta = \frac{\sum_{j=1}^n [|V_{Oj(+)} - V_{COM}| I_{Oj}]}{[V_{I(+)} - V_{I(-)}] I_i} \times 100 \quad \%$$

Figure 34. ME005BK, CL Output Voltage and Efficiency Measurement Test Setup

Design Considerations

Input Reflected Ripple

An internal aluminum electrolytic input capacitor is used for filtering; therefore, input ripple increases as temperature decreases. There is approximately two times more ripple at 0 °C than at 25 °C and eight times more ripple at -40 °C than at 25 °C. The power module functions properly down to -40 °C with no additional filtering. If ripple comparable to that at 25 °C is needed at low temperatures, an external capacitor across the input with an impedance of 0.5 Ω at 100 kHz over the desired temperature range is recommended.

Output Voltage Reversal

CAUTION: Applying a reverse voltage across the module output forward biases an internal diode. Attempting to start the module under this condition can damage the module.

Safety Considerations

For safety-agency approval of the system in which the power module is used, the power module must be installed in compliance with the spacing and separation requirements of the end-use safety agency standard, i.e., UL 1950, CSA C22.2 No. 950-95, and VDE 0805 (EN60950, IEC950).

If the input source is non-SELV (ELV or a hazardous voltage greater than 60 Vdc and less than or equal to 75 Vdc), for the module's output to be considered meeting the requirements of safety extra-low voltage (SELV), all of the following must be true:

- n The input source is to be provided with reinforced insulation from any other hazardous voltages, including the ac mains.
- n One Vi pin and one Vo pin are to be grounded or both the input and output pins are to be kept floating.
- n The input pins of the module are not operator accessible.
- n Another SELV reliability test is conducted on the whole system, as required by the safety agencies, on the combination of supply source and the subject module to verify that under a single fault, hazardous voltages do not appear at the module's output.

Note: Do not ground either of the input pins of the module without grounding one of the output pins. This may allow a non-SELV voltage to appear between the output pins and ground.

The power module has extra-low voltage (ELV) outputs when all inputs are ELV.

The input to these units is to be provided with a maximum 5 A normal-blow fuse in the ungrounded lead.

Feature Descriptions

Overcurrent Protection

To provide protection in a fault (output overload) condition, the unit is equipped with internal current-limiting circuitry and can endure current limiting for an unlimited duration. At the point of current-limit inception, the unit shifts from voltage control to current control. If the output voltage is pulled very low during a severe fault, the current-limit circuit can exhibit either foldback or tailout characteristics (output current decrease or increase). The unit operates normally once the output current is brought back into its specified range.

Output Overvoltage Protection

The output overvoltage clamp consists of control circuitry, which is independent of the primary regulation loop, that monitors the voltage on the output terminals. The control loop of the clamp has a higher voltage set point than the primary loop (see Feature Specifications table). This provides a redundant voltage-control that reduces the risk of output overvoltage.

Outline Diagrams

Dimensions are in millimeters and (inches).

Module tolerances, unless otherwise indicated: $x.x \pm 0.5$ mm (0.02 in.), $x.xx \pm 0.25$ mm (0.010 in.).

Single-Output Module

Top View

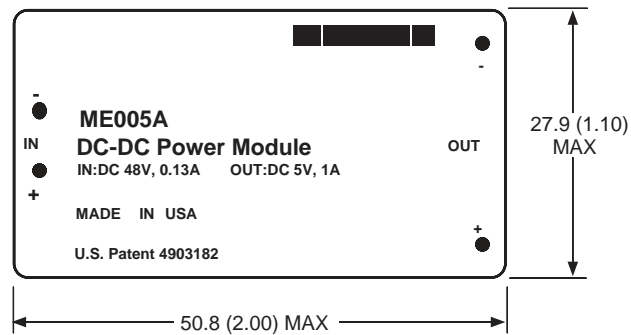

Side View

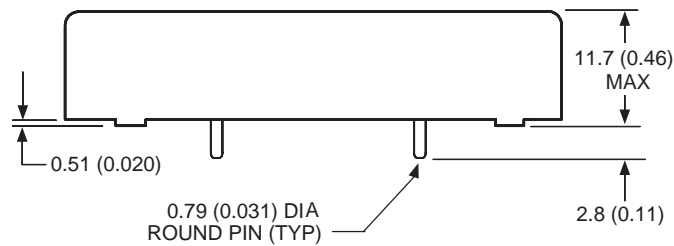

Bottom View

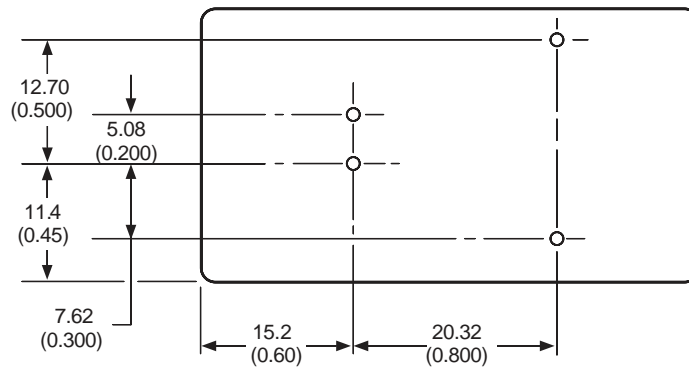

8-356(C)

Outline Diagrams (continued)

Dimensions are in millimeters and (inches).

Module tolerances, unless otherwise indicated: $x.x \pm 0.5$ mm (0.02 in.), $x.xx \pm 0.25$ mm (0.010 in.).

Dual-Output Module

Top View

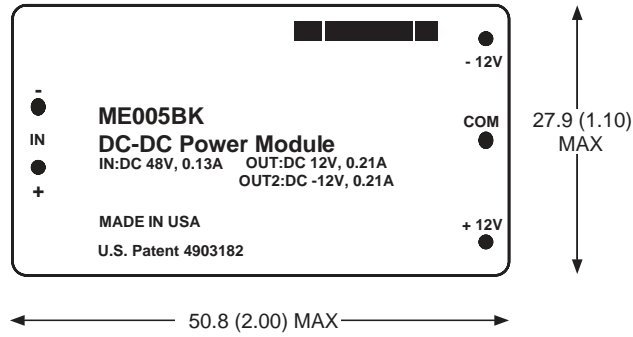

Side View

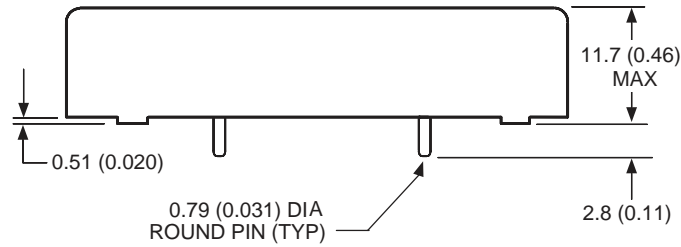

Bottom View

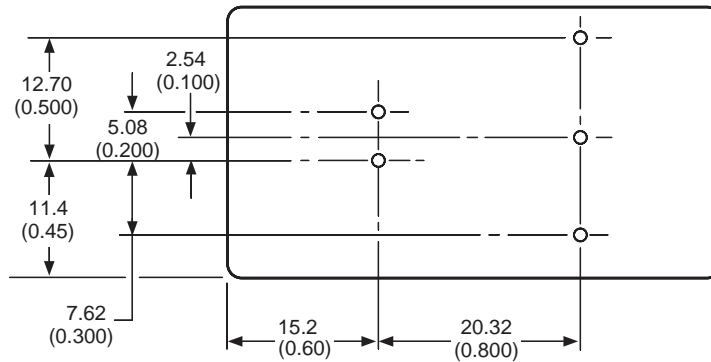

8-356(C)

Recommended Hole Patterns

Component-side footprint.

Dimensions are in millimeters and (inches).

Single-Output Module

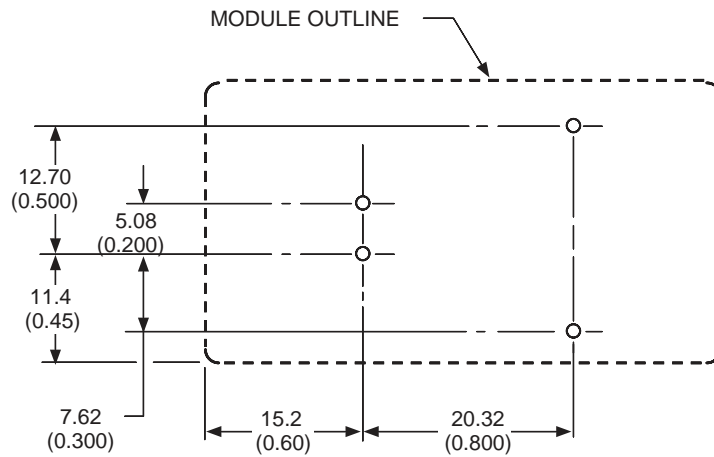

8-356(C)

Dual-Output Module

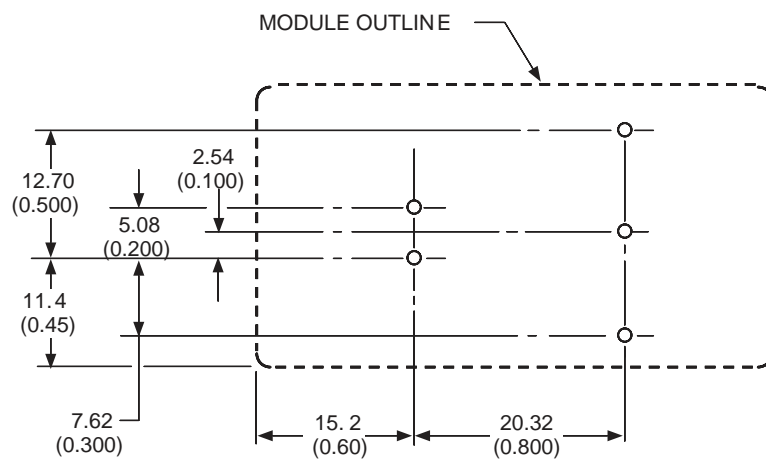

8-356(C)

Ordering Information

For assistance in ordering, please contact your Lineage Power Account Manager or Application Engineer.

Table 4. Device Codes

Input Voltage	Output Voltage	Output Power	Device Code	Comcode
39.5 V—60 V	5 V	5 W	ME005A	105524185
39.5 V—60 V	5.2 V	5 W	ME005N	106197619
39.5 V—60 V	12 V	5 W	ME005B	105550487
39.5 V—60 V	15 V	5 W	ME005C	105550495
39.5 V—60 V	+12 V, -12 V	5 W	ME005BK	105569891
39.5 V—60 V	+15 V, -15 V	5 W	ME005CL	105728786

Table 5. Device Options

Option	Device Suffix
Long pins: 5.8 mm (0.230 in.)	-SLP

Notes



World Wide Headquarters

Lineage Power Corporation

3000 Skyline Drive, Mesquite, TX 75149, USA

+1-800-526-7819

(Outside U.S.A. : **+1-972-284-2626**)

www.lineagepower.com

e-mail: techsupport1@lineagepower.com

Asia-Pacific Headquarters

Tel: +65 641 6 4283

Europe, Middle-East and Africa Headquarters

Tel: +49 89 6089 286

India Headquarters

Tel: +91 80 28411633

Lineage Power reserves the right to make changes to the product(s) or information contained herein without notice. No liability is assumed as a result of their use or application. No rights under any patent accompany the sale of any such product(s) or information.

© 2008 Lineage Power Corporation, (Mesquite, Texas) All International Rights Reserved.