

EZ-LIGHT® Touch K30 Series Illuminated Multipurpose Buttons

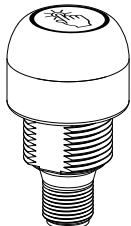

Datasheet

General purpose multicolor indicator with independent momentary touch button output



- Rugged, cost-effective, and easy-to-install multicolor indicator with touch button
- Waterproof IP69K construction for washdown environments
- Two independent colors in one unit—Color 2 overrides Color 1
- Available with PNP and NPN inputs/outputs, depending on model
- Ergonomically designed to eliminate hand, wrist, and arm stresses associated with repeated switch operation; require no physical force to operate
- Can be actuated with bare hands or in gloves
- 12 V dc to 30 V dc operation

Models

Model ¹	I/O Type	Output State	Light Color 1 (Power Applied)	Light Color 2 (Input Active)	Connection	
K30APTXR2F2Q	PNP	N.O.	-	Red	Integral 4-pin M12/Euro-style male quick disconnect (QD)	
K30APTXXGF2Q			-	Green		
K30APTGRF2Q			Green	Red		
K30APTRGF2Q			Red	Green		
K30ANTXR2F2Q	NPN		-	Red		Integral 4-pin M12/Euro-style male quick disconnect (QD)
K30ANTXGF2Q			-	Green		
K30ANTGRF2Q			Green	Red		
K30ANTRGF2Q			Red	Green		

Wiring

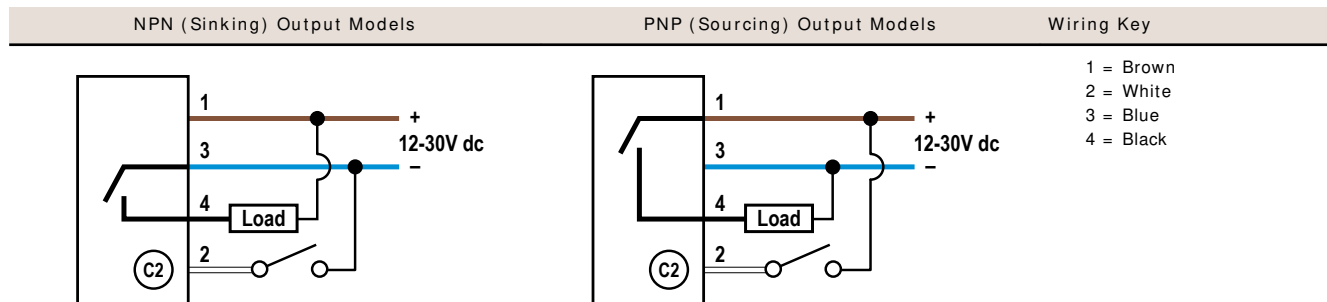

Cabled wiring diagrams are shown. Quick disconnect (QD) wiring diagrams are functionally identical.

¹ Integral QD models only are listed.

- To order the 4-pin 150 mm (5.9 in) Euro-style PVC pigtail models, replace suffix Q with QP in the model number (example, K30APTXXRF2QP).
- To order the 2 m (6.5 ft) cable models, omit suffix Q from the model number (example, K30APTXXRF2).
- A model with a QD requires a mating cable (see Cordsets).



Specifications

Supply Voltage
12 V dc to 30 V dc

Supply Current
55 mA max current (exclusive of load)

Supply/ Output Protection Circuitry
Protected against reverse polarity and transient voltages

Output Rating
Maximum Load: 150 mA
ON-state saturation voltage: < 2 V dc at 10 mA; < 2.5 V dc at 150 mA
OFF-state leakage current: < 10 µA at 30 V dc

Environmental Rating
IEC IP67, IP69K per DIN 40050-9.
Cabled models also meet IP69K if the cable and cable entrance are protected from high-pressure spray.
Enclosure Type 4X, 13

Operating Conditions
Temperature: -40 °C to +50 °C (-40 °F to +122 °F)
Humidity: 90% at +50 °C maximum relative humidity (non-condensing)

Storage Temperature
-40 °C to +70 °C (-40 °F to +158 °F)

Vibration and Mechanical Shock
All models meet Mil. Std. 202F requirements method 201A (vibration: 10 Hz to 60 Hz max., double amplitude 0.06 in. maximum acceleration 10G). Also meets IEC 947-5-2; 30G 11 ms duration, half sine wave.

Certifications



Output Response Time
150 milliseconds On and Off

Power-Up Delay
300 milliseconds

Connections
Integral 4-pin M12/Euro-style male quick disconnect (QD); 2 m (6.5 ft) PVC integral cable; 150 mm (6 in) PVC cable with a 4-pin M12/Euro-style male quick disconnect (QD)

Construction
Housing: polycarbonate
Translucent dome: polycarbonate
Mounting nut: PBT

Mounting
M22 x 1.5 Threaded base, max torque 2.25 N-m (20 in-lbf)

Required Overcurrent Protection



WARNING: Electrical connections must be made by qualified personnel in accordance with local and national electrical codes and regulations.

Overcurrent protection is required to be provided by end product application per the supplied table.
Overcurrent protection may be provided with external fusing or via Current Limiting, Class 2 Power Supply.
Supply wiring leads < 24 AWG shall not be spliced.
For additional product support, go to www.bannerengineering.com.

Supply Wiring (AWG)	Required Overcurrent Protection (Amps)
20	5.0
22	3.0
24	2.0
26	1.0
28	0.8
30	0.5

Dimensions

All measurements are listed in millimeters [inches], unless noted otherwise.

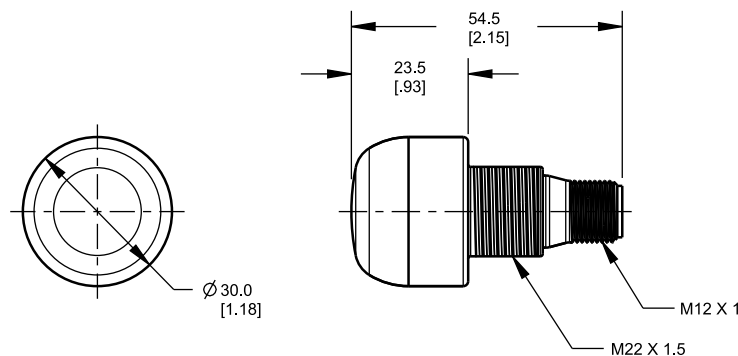

Accessories

Cordsets

4-Pin Threaded M12/ Euro-Style Cordsets				
Model	Length	Style	Dimensions	Pinout (Female)
MQDC-406	1.83 m (6 ft)	Straight		<p>1 = Brown 2 = White 3 = Blue 4 = Black</p>
MQDC-415	4.57 m (15 ft)			
MQDC-430	9.14 m (30 ft)			
MQDC-450	15.2 m (50 ft)			
MQDC-406RA	1.83 m (6 ft)	Right-Angle		
MQDC-415RA	4.57 m (15 ft)			
MQDC-430RA	9.14 m (30 ft)			
MQDC-450RA	15.2 m (50 ft)			

Brackets

SMB22A

- Right-angle bracket with curved slot for versatile orientation
- 12-ga. stainless steel
- Mounting hole for 22 mm sensor

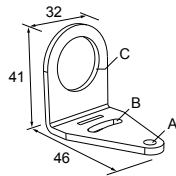

Hole center spacing: A to B = 26.0
Hole size: A = ø 4.6, B = 4.6 x 16.9, C = 22.2

SMB22FVK

- V-clamp, flat bracket and fasteners for mounting to pipe or extensions
- Clamp accommodates 28 mm diameter tubing or 1 in. square extrusions
- 22 mm hole for mounting sensor

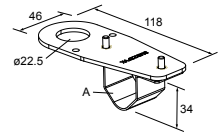

Hole size: A = ø 22.5

SMB22RAVK

- V-clamp, right-angle bracket and fasteners for mounting to pipe or extensions
- Clamp accommodates 28 mm diameter tubing or 1 in. square extrusions
- 22 mm hole for mounting sensor

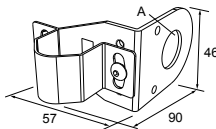

Hole size: A = ø 22.5

SMBAMS22P

- Flat SMBAMS series bracket with 22 mm hole for mounting sensors
- Articulation slots for 90+° rotation
- 12-ga. (2.6 mm) cold-rolled steel

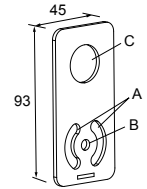

Hole center spacing: A = 26.0, A to B = 13.0
Hole size: A = 26.8 x 7.0, B = ø 6.5, C = ø 22.5

SMBAMS22RA

- Right-angle SMBAMS series bracket with 22 mm hole for mounting sensors
- Articulation slots for 90+° rotation
- 12-ga. (2.6 mm) cold-rolled steel

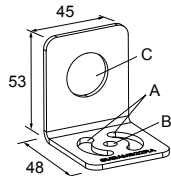

Hole center spacing: A = 26.0, A to B = 13.0
Hole size: A = 26.8 x 7.0, B = ø 6.5, C = ø 22.5

TC-K30-CL

- Touch cover

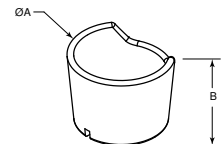

Diameter: A = 40.7
Height: B = 31

All measurements are listed in millimeters, unless noted otherwise.

Banner Engineering Corp. Limited Warranty

Banner Engineering Corp. warrants its products to be free from defects in material and workmanship for one year following the date of shipment. Banner Engineering Corp. will repair or replace, free of charge, any product of its manufacture which, at the time it is returned to the factory, is found to have been defective during the warranty period. This warranty does not cover damage or liability for misuse, abuse, or the improper application or installation of the Banner product.

THIS LIMITED WARRANTY IS EXCLUSIVE AND IN LIEU OF ALL OTHER WARRANTIES WHETHER EXPRESS OR IMPLIED (INCLUDING, WITHOUT LIMITATION, ANY WARRANTY OF MERCHANTABILITY OR FITNESS FOR A PARTICULAR PURPOSE), AND WHETHER ARISING UNDER COURSE OF PERFORMANCE, COURSE OF DEALING OR TRADE USAGE.

This Warranty is exclusive and limited to repair or, at the discretion of Banner Engineering Corp., replacement. IN NO EVENT SHALL BANNER ENGINEERING CORP. BE LIABLE TO BUYER OR ANY OTHER PERSON OR ENTITY FOR ANY EXTRA COSTS, EXPENSES, LOSSES, LOSS OF PROFITS, OR ANY INCIDENTAL, CONSEQUENTIAL OR SPECIAL DAMAGES RESULTING FROM ANY PRODUCT DEFECT OR FROM THE USE OR INABILITY TO USE THE PRODUCT, WHETHER ARISING IN CONTRACT OR WARRANTY, STATUTE, TORT, STRICT LIABILITY, NEGLIGENCE, OR OTHERWISE.

Banner Engineering Corp. reserves the right to change, modify or improve the design of the product without assuming any obligations or liabilities relating to any product previously manufactured by Banner Engineering Corp. Any misuse, abuse, or improper application or installation of this product or use of the product for personal protection applications when the product is identified as not intended for such purposes will void the product warranty. Any modifications to this product without prior express approval by Banner Engineering Corp will void the product warranties. All specifications published in this document are subject to change; Banner reserves the right to modify product specifications or update documentation at any time. Specifications and product information in English supersede that which is provided in any other language. For the most recent version of any documentation, refer to: www.bannerengineering.com.