

# GLB-1 | Articulated side guides

Technopolymer, stainless steel



- 1
- 2
- 3
- 4
- 5
- 6
- 7
- 8
- 9
- 10
- 11
- 12
- 13
- 14
- 15
- 16
- 17
- 18

## SELF-SUPPORTING STRUCTURE

Acetal resin based (POM) technopolymer, black colour.

## PINS

AISI 304 stainless steel.

## ROLLERS

Polyethylene based (PE) technopolymer, grey colour.

## STANDARD EXECUTIONS

- GLB-1-RS: with shaped rollers, spherical contact.
- GLB-1-RC: with cylindrical rollers.
- GLB-1-RT: with shaped rollers, cylindrical contact.

## FEATURES AND APPLICATIONS

GLB-1 side guides are modular self-supporting structures for the side guide of products with limited vertical dimensions on conveyor belts (Fig. 1).

Particularly suitable for use in wet environments.

Depending on the product to transport, it is recommended to use:

- GLB-1-RS: for the guide of products in cans or in plastic containers;
- GLB-1-RC: for the guide of cardboard products, for a greater fluency;
- GLB-1-RT: for the guide of glass products, in case of accidental breakage they facilitate the expulsion of debris.

The joint in the roller side guides allows an external curvature radius 500 mm, internal curvature radius 350 mm.

Supplied already assembled in modules of 375 mm length, for profiles 40x8 mm.

## SPECIAL EXECUTIONS ON REQUEST

- Side guides with self-supporting structure and rollers in different colours.
- Side guides with pins in acetal resin based (POM) technopolymer.

## ACCESSORIES ON REQUEST

- PRA-GLB: AISI 304 stainless steel profile for side guides.
- PRB-GLB: AISI 304 stainless steel profile for side guides.

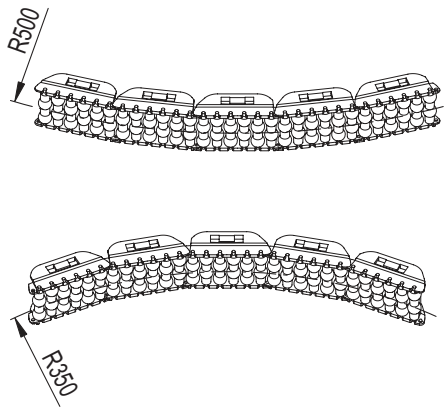
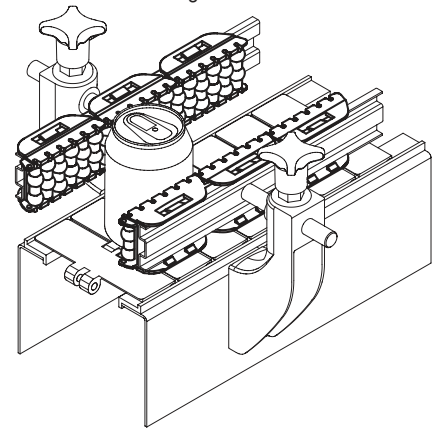
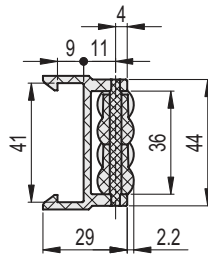
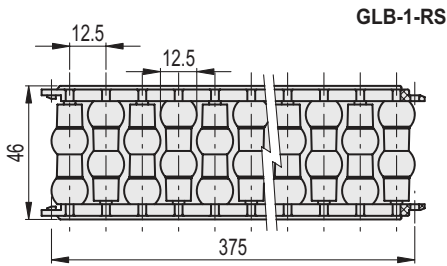

Fig. 1



Levelling elements and supports

- 1
- 2
- 3
- 4
- 5
- 6
- 7
- 8
- 9
- 10
- 11
- 12
- 13
- 14
- 15
- 16
- 17
- 18



**GLB-1-RS**

Code	Description	Weight
419161	GLB-1-RS-46-375	340

**METRIC**  
**INOX** STAINLESS STEEL

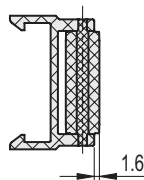
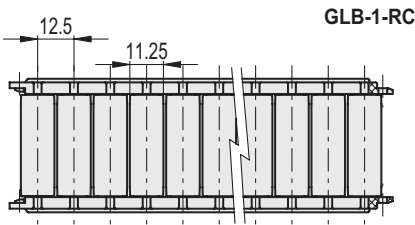

**GLB-1-RC**

Code	Description	Weight
419162	GLB-1-RC-46-375	340

**METRIC**  
**INOX** STAINLESS STEEL

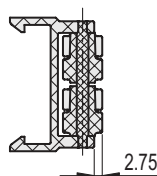
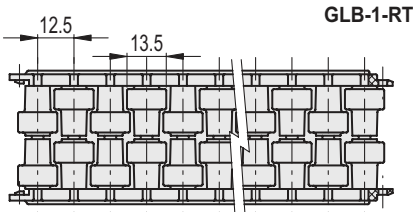

**GLB-1-RT**

Code	Description	Weight
419163	GLB-1-RT-46-375	340

**METRIC**  
**INOX** STAINLESS STEEL

Leveling elements and supports