



AMP | AMP Twin-Leaf

TE Internal #: 583853-2

Connector Contact, Socket, Wire-to-Board, 24 – 20 AWG Wire Size, 404 – 1020 CMA Wire Size, .2 – .6 mm² Wire Size, Gold, Strip, AMP Twin-Leaf

[View on TE.com >](#)

Connectors > PCB Connectors > Wire-to-Board Connectors > Wire-to-Board Connector Contacts

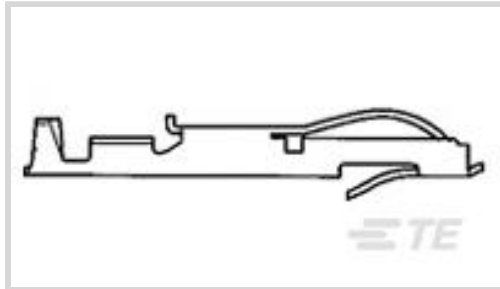

Contact Type: **Socket**

Connector System: **Wire-to-Board**

Centerline (Pitch): **2.54 mm, 3.18 mm, 3.96 mm [.156 in]**

Wire Size: **404 – 1020 CMA**

Features

Product Type Features

Connector System	Wire-to-Board
Connector & Contact Terminates To	Wire & Cable

Contact Features

Contact Retention Within Housing	With 15 µin
Wire Contact Termination Area Plating Material	Tin-Lead
PCB Contact Termination Area Plating Material	Nickel
Contact Base Material	Phosphor Bronze
Contact Type	Socket
Contact Mating Area Plating Material	Gold
Contact Current Rating (Max)	5 A

Termination Features

Termination Method to Wire & Cable	Crimp
------------------------------------	-------

Mechanical Attachment

Contact Retention Type Within Housing	Locking Lance
---------------------------------------	---------------

Housing Features

Centerline (Pitch)	2.54 mm, 3.18 mm, 3.96 mm [.156 in]
--------------------	-------------------------------------

Dimensions

--	--



Compatible Insulation Diameter Range	1.22 – 1.52 mm [.048 – .06 in]
--------------------------------------	--------------------------------

Wire Size	.2 – .6 mm ²
-----------	-------------------------

Usage Conditions

Operating Temperature Range	-40 – 85 °C [-40 – 185 °F]
-----------------------------	----------------------------

Operation/Application

Circuit Application	Power & Signal
---------------------	----------------

Identification Marking

Wire Range Color Code	Green
-----------------------	-------

Packaging Features

Packaging Quantity	7000
--------------------	------

Packaging Method	Strip
------------------	-------

Product Compliance

[For compliance documentation, visit the product page on TE.com>](#)

EU RoHS Directive 2011/65/EU	Not Compliant
------------------------------	---------------

EU ELV Directive 2000/53/EC	Compliant with Exemptions
-----------------------------	---------------------------

China RoHS 2 Directive MIIT Order No 32, 2016	Restricted Materials Above Threshold
---	--------------------------------------

EU REACH Regulation (EC) No. 1907/2006	<p>Current ECHA Candidate List: JUNE 2023 (235)</p> <p>Candidate List Declared Against: JUNE 2023 (235)</p> <p>SVHC > Threshold:</p> <p>Pb (13% in Component Part)</p>
--	---

Article Safe Usage Statements:
Do not eat, drink or smoke when using this product. Wash thoroughly after handling. Recycle if possible and dispose of the article by following all applicable governmental regulations relevant to your geographic location.

Halogen Content	Low Halogen - Br, Cl, F, I < 900 ppm per homogenous material. Also BFR/CFR/PVC Free
-----------------	---

Solder Process Capability	Not applicable for solder process capability
---------------------------	--

Product Compliance Disclaimer

This information is provided based on reasonable inquiry of our suppliers and represents our current actual knowledge based on the information they provided. This information is subject to change. The part numbers that TE has identified as EU RoHS compliant have a maximum concentration of 0.1% by weight in homogenous materials for lead, hexavalent chromium, mercury, PBB, PBDE, DBP, BBP, DEHP, DIBP, and 0.01% for cadmium, or qualify for an exemption to these limits as defined in the Annexes of Directive 2011/65/EU (RoHS2). Finished electrical and electronic equipment products will be CE marked as required by Directive 2011/65/EU. Components may not be CE marked. Additionally, the part numbers that TE has identified as EU ELV compliant have a maximum concentration of 0.1% by weight in homogenous materials for lead, hexavalent chromium, and mercury, and 0.01% for cadmium, or qualify for an exemption to these limits as defined in the Annexes of Directive 2000/53/EC (ELV). Regarding the REACH Regulation, the information TE provides on SVHC in articles for this part number is based on the latest European Chemicals Agency (ECHA) 'Guidance on

requirements for substances in articles' posted at this URL: <https://echa.europa.eu/guidance-documents/guidance-on-reach>

Compatible Parts

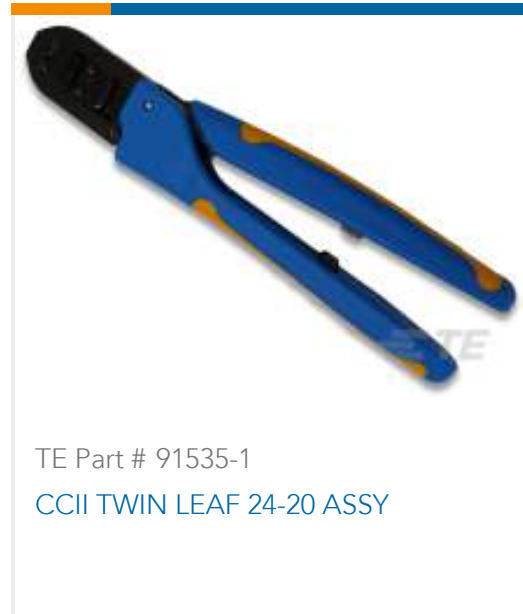
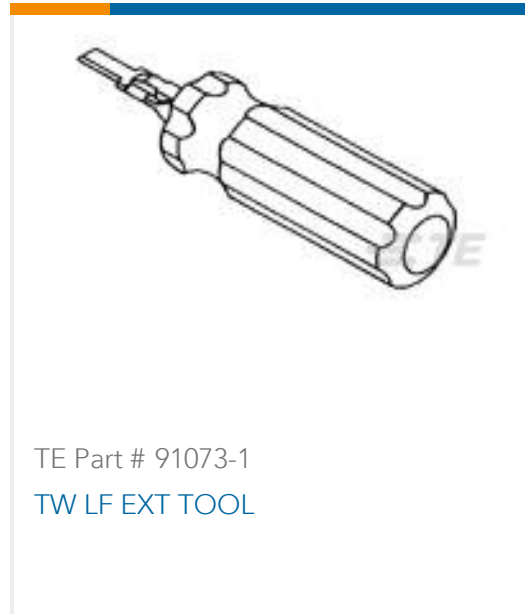

Also in the Series | AMP Twin-Leaf

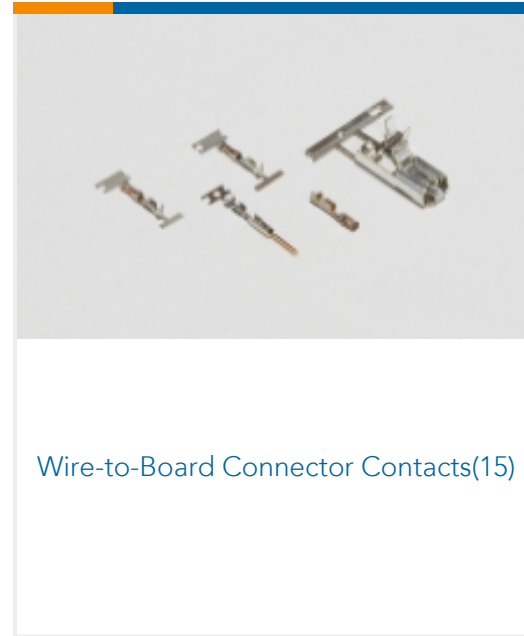
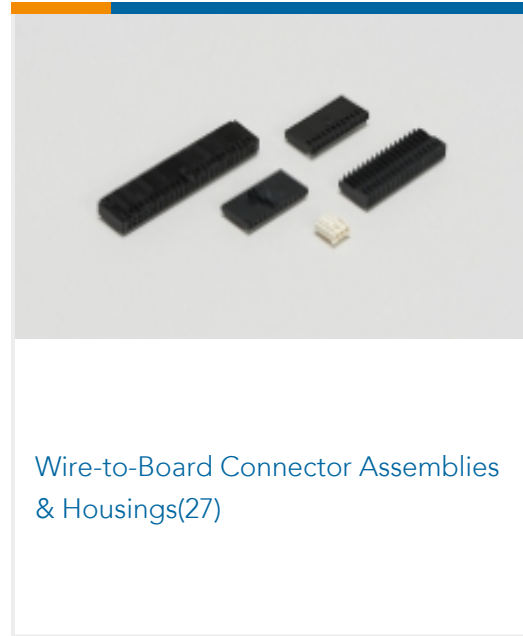
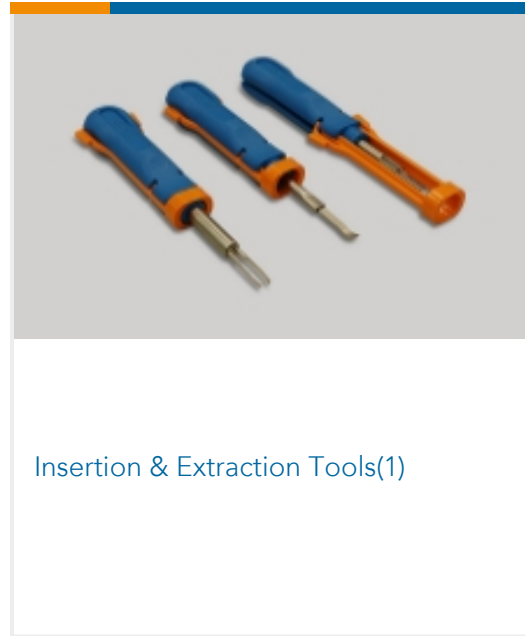

Customers Also Bought

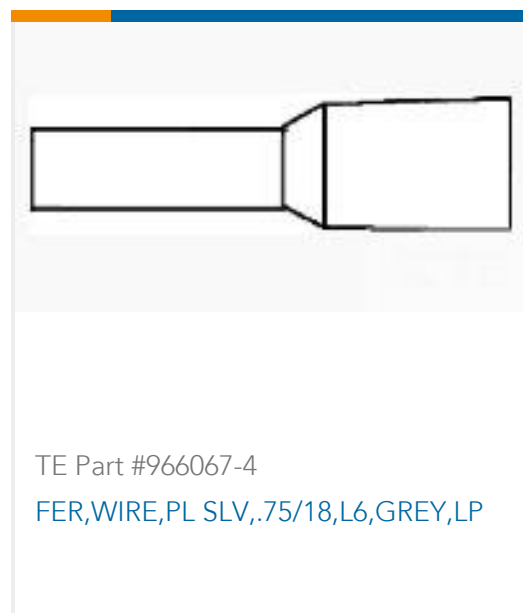
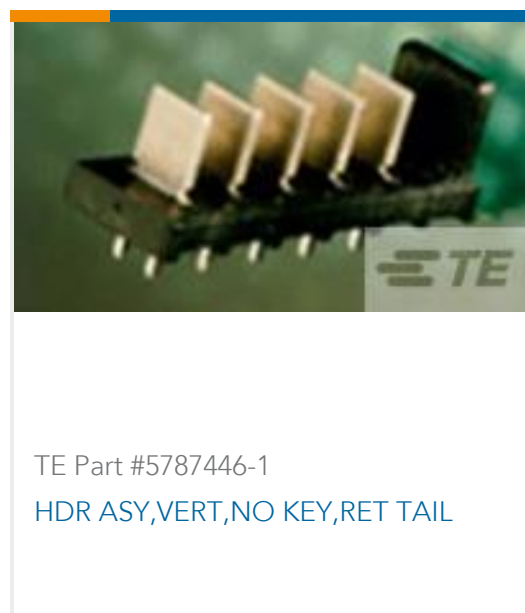

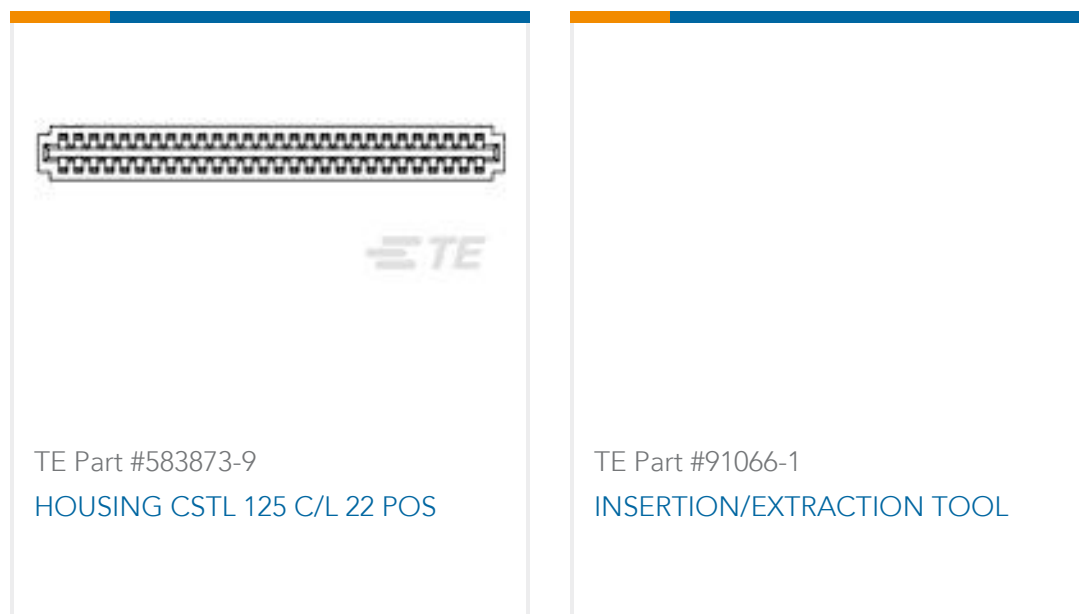

Documents

Product Drawings

[CONT.CRP.SNAP TW.LF.STRIP](#)

English

CAD Files

[3D PDF](#)

3D

Customer View Model

[ENG_CVM_CVM_583853-2_BR.2d_dxf.zip](#)

English

Customer View Model

[ENG_CVM_CVM_583853-2_BR.3d_igs.zip](#)

English

Customer View Model

[ENG_CVM_CVM_583853-2_BR.3d_stp.zip](#)

English

Customer View Model

[ENG_CVM_583853-2_V1.3d_igs.zip](#)

English

Customer View Model

[ENG_CVM_583853-2_V1.3d_stp.zip](#)

English

[3D PDF](#)

English

Customer View Model

[ENG_CVM_583853-2_V1.2d_dxf.zip](#)

English

By downloading the CAD file I accept and agree to the [Terms and Conditions](#) of use.

Product Specifications

[Application Specification](#)

English