

DESCRIPTION: HIGH DENSITY VERTICAL LOW PROFILE/STAMPED

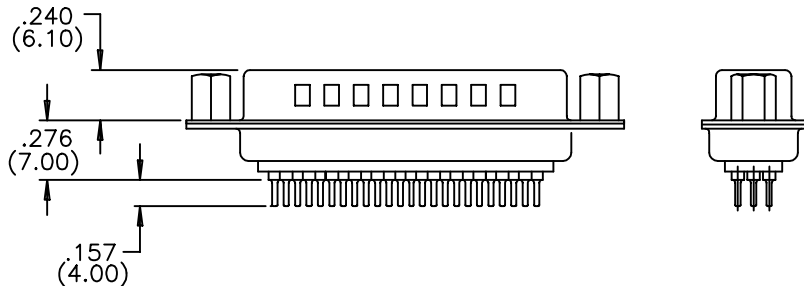
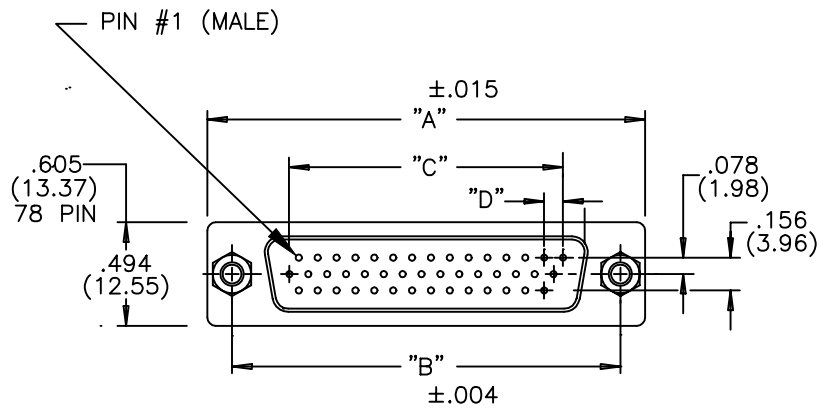

195-XXX-X13-XX1

SERIES _____
 NUMBER OF CONTACTS _____
 GENDER _____
 1 = MALE
 2 = FEMALE (NO GROUND INDENTS)
 PC MOUNT _____
 NICKEL SHELL _____
 HARDWARE OPTIONS: _____
 00 = .120 MOUNTING HOLE
 55 = 4-40 INSERTS
 03 = 4-40 HEX STANDOFFS
 PLATING: _____
 1 = GOLD FLASH

MATERIALS:

INSULATOR: THERMOPLASTIC POLYESTER, UL94V-0
 CHEMICAL RESISTANCE, COLOR BLACK

SHELL: STEEL, NICKEL PLATED

CONTACT: MALE:BRASS; FEMALE: PHOSPHOR BRONZE
 GOLD FLASH IN MATING AREA
 TIN-LEAD PLATING ON TAIL ENDS

ELECTRICAL:

CURRENT RATING: 2 AMPERES
 DIELECTRIC WITHSTANDING VOLTAGE:
 1000VAC rms AT SEA LEVEL
 INSULATION RESISTANCE: 5000 MEGOHMS MIN.
 CONTACT RESISTANCE: 10 MILLIOHMS MAX.
 WORKING TEMPERATURE: -55° TO +125° C

NUMBER OF CONTACTS	"A"	"B"	"C"	"D"
	Inch (mm)	Inch (mm)	Inch (mm)	Inch (mm)
15	1.214 (30.84)	.984 (24.99)	.405 (10.29)	.090 (2.29)
26	1.545 (39.24)	1.312 (33.32)	.765 (19.43)	.090 (2.29)
44	2.088 (53.04)	1.852 (47.04)	1.305 (33.15)	.090 (2.29)
62	2.730 (69.34)	2.500 (63.50)	1.948 (49.47)	.095 (2.41)
78	2.635 (66.93)	2.406 (61.11)	1.805 (45.85)	.095 (2.41)

	THESE DRAWINGS AND SPECIFICATIONS ARE THE PROPERTY OF NorComp AND SHALL NOT BE REPRODUCED, COPIED OR USED AS THE BASIS FOR THE MANUFACTURE OF SALE OF APPARATUS WITHOUT WRITTEN PERMISSION.		DRAWN: PAM JENKINS	DATE: 5-10-01	
	<h1>NorComp</h1>			CHECKED:	DATE:
SCALE:				SHEET 1 OF 1	REV 2
DWG NO. 195-XXX-113-XX1					

DESCRIPTION: HIGH DENSITY DIP SOLDER MALE FOOTPRINT

78 POSITION MALE

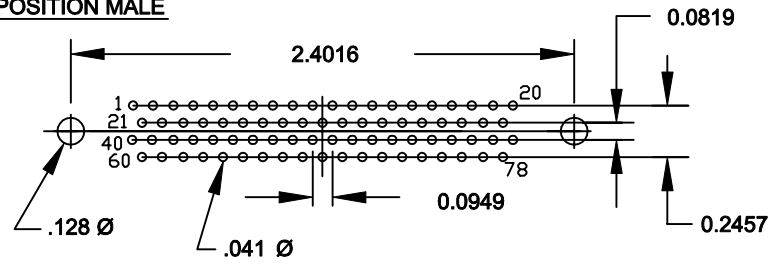

26 POSITION MALE

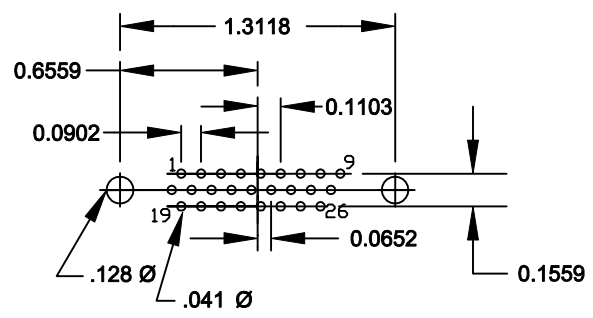

62 POSITION MALE

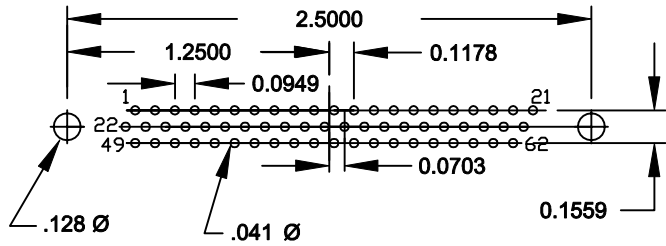

15 POSITION MALE

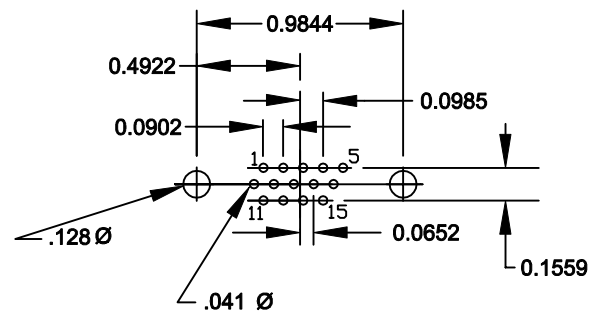

44 POSITION MALE

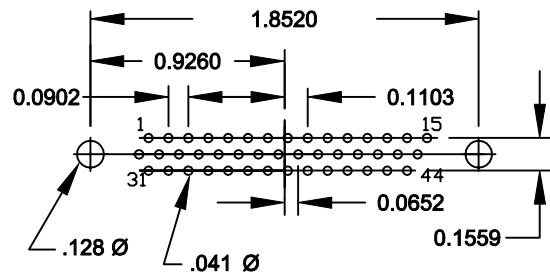

	THESE DRAWINGS AND SPECIFICATIONS ARE THE PROPERTY OF NorComp AND SHALL NOT BE REPRODUCED, COPIED OR USED AS THE BASIS FOR THE MANUFACTURE OF SALE OF APPARATUS WITHOUT WRITTEN PERMISSION.		DRAWN: PAM JENKINS	DATE: 10-29-01	
	<h1>NorComp</h1>			CHECKED:	DATE:
SCALE:				SHEET 1 OF 1	REV 2
DWG NO. HIGH DENSITY VERTICAL MALE FOOTPRINT					