

PACKAGE DIMENSIONS

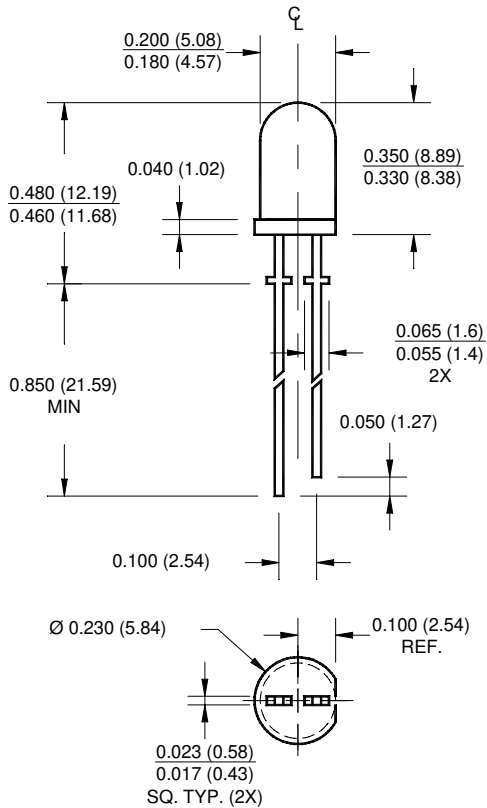

HLMP-3X50A

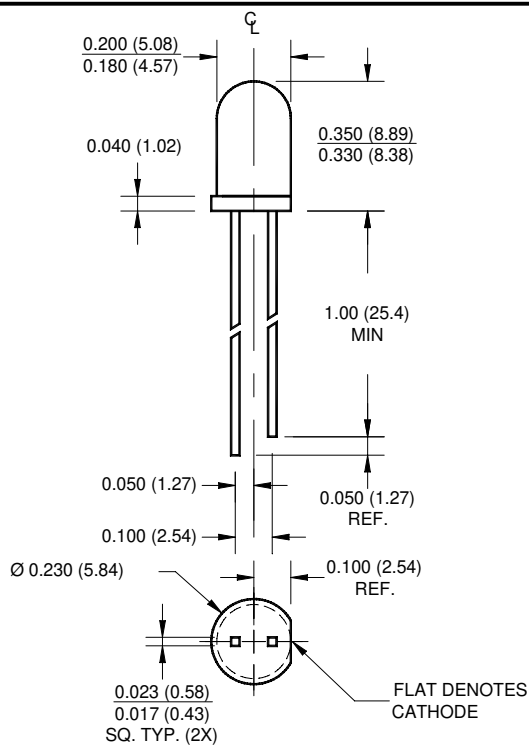

MV3X50

HLMP-3X50A
MV3X50

FEATURES

- Pale tint
- Sturdy leads with or without stand-off on T-1 3/4
- Excellent for small area backlighting
- HER
 - HLMP-3750A
 - MV3750
- Green
 - HLMP-3950A
 - MV3450
- Yellow
 - HLMP-3850A
 - MV3350

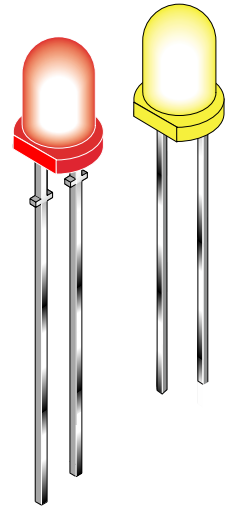

DESCRIPTION

The HLMP-3X50 series consists of tinted and water clear T-1 3/4 LED lamps with standoffs.

The MV3X50 series is the same as Agilent's HLMP-3X50A series, except for the standoffs.

Both series are available in red, yellow and green with a minimum intensity of 80mcd.

NOTES:

ALL DIMENSIONS ARE IN INCHES (mm).

ABSOLUTE MAXIMUM RATING (T_A =25°C)

| Parameter | HER | YELLOW | GREEN | UNITS |
|-------------------------------|-------------|-------------|-------------|-------|
| Power Dissipation | 135 | 85 | 135 | mW |
| Peak Forward Current | 90 | 60 | 90 | mA |
| Continuous DC Forward Current | 30 | 20 | 30 | mA |
| Lead Soldering Time at 260° C | 5 | 5 | 5 | sec |
| Operating Temperature | -55 to +100 | -55 to +100 | -50 to +100 | °C |
| Storage Temperature | -55 to +100 | -55 to +100 | -50 to +100 | °C |

ELECTRICAL / OPTICAL CHARACTERISTICS (T_A =25°C)

| Parameter | MV3750 | MV3350 | MV3450 | Condition |
|--------------------------|------------|------------|------------|------------------------|
| | HLMP-3750A | HLMP-3850A | HLMP-3950A | |
| Luminous Intensity (mcd) | | | | I _F = 20mA |
| Minimum | 80 | 80 | 80 | |
| Typical | 150 | 150 | 150 | |
| Forward Voltage (V) | | | | I _F = 20mA |
| Maximum | 3.0 | 3.0 | 3.0 | |
| Typical | 2.2 | 2.2 | 2.2 | |
| Peak Wavelength (nm) | 635 | 585 | 565 | I _F = 20mA |
| Reverse Voltage (V) | 5 | 5 | 5 | I _R = 100μA |
| Viewing Angle (°) | 24 | 24 | 24 | I _F = 20mA |

TYPICAL PERFORMANCE CURVES ($T_A = 25^\circ\text{C}$)

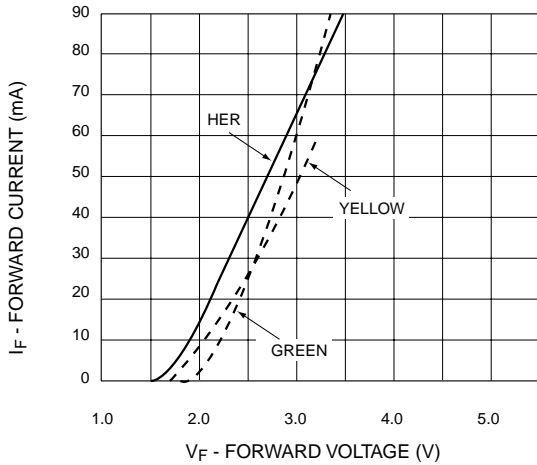

Fig. 1 Forward Current vs. Forward Voltage

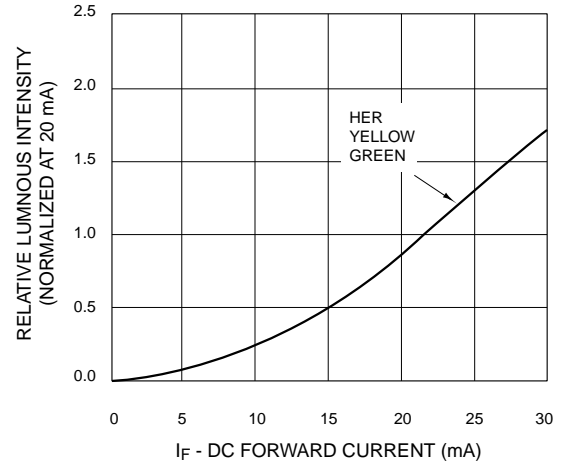

Fig. 2 Relative Luminous Intensity vs. DC Forward Current

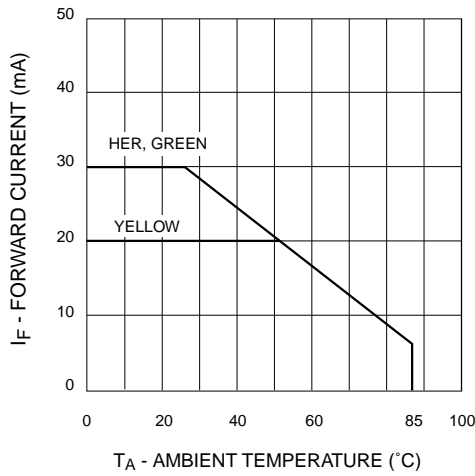

Fig. 3 Current Derating Curve

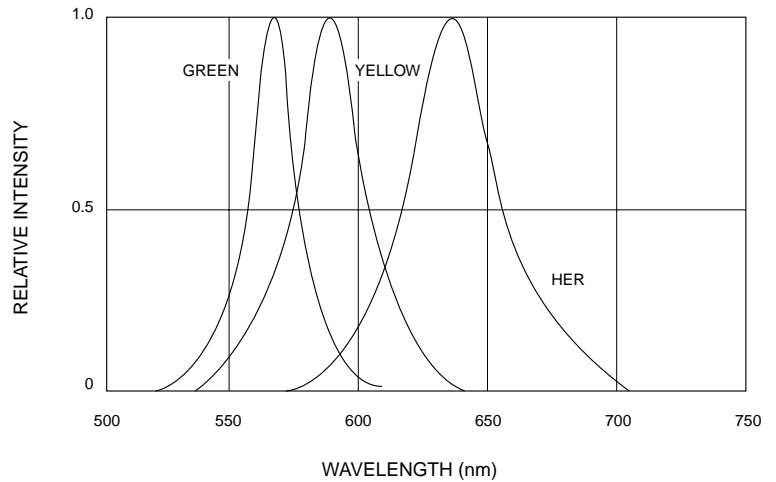
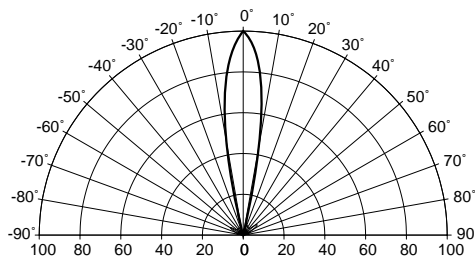

Fig. 4 Relative Intensity vs. Peak Wavelength



REL. LUMINOUS INTENSITY (%)

Fig. 5 Radiation Diagram

DISCLAIMER

FAIRCHILD SEMICONDUCTOR RESERVES THE THE RIGHT TO MAKE CHANGES WITHOUT FURTHER NOTICE TO ANY PRODUCTS HEREIN TO IMPROVE RELIABILITY, FUNCTION OR DESIGN. FAIRCHILD DOES NOT ASSUME ANY LIABILITY ARISING OUT OF THE APPLICATION OR USE OF ANY PRODUCT OR CIRCUIT DESCRIBED HEREIN; NEITHER DOES IT CONVEY ANY LICENSE UNDER ITS PATENT RIGHTS, NOR THE RIGHTS OF OTHERS.

LIFE SUPPORT POLICY

FAIRCHILD'S PRODUCTS ARE NOT AUTHORIZED FOR USE AS CRITICAL COMPONENTS IN LIFE SUPPORT DEVICES OR SYSTEMS WITHOUT THE EXPRESS WRITTEN APPROVAL OF THE PRESIDENT OF FAIRCHILD SEMICONDUCTOR CORPORATION. As used herein:

1. Life support devices or systems are devices or systems which, (a) are intended for surgical implant into the body, or (b) support or sustain life, and (c) whose failure to perform when properly used in accordance with instructions for use provided in labeling, can be reasonably expected to result in a significant injury of the user.
2. A critical component in any component of a life support device or system whose failure to perform can be reasonably expected to cause the failure of the life support device or system, or to affect its safety or effectiveness.