

TPA6102A2

50-mW ULTRALOW-VOLTAGE, FIXED-GAIN STEREO HEADPHONE AUDIO POWER AMPLIFIER

SLOS324B – JUNE 2000 – REVISED SEPTEMBER 2004

- 50-mW Stereo Output
- Low Supply Current . . . 0.75 mA
- Low Shutdown Current . . . 50 nA
- Minimal External Components Required
- Gain Set Internally to 14 dB
- Pop Reduction Circuitry
- Internal Mid-Rail Generation
- Thermal and Short-Circuit Protection
- Surface-Mount Packaging
 - MSOP
 - SOIC
- 1.6-V to 3.6-V Supply Voltage Range

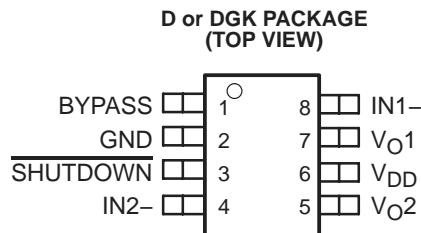

description

The TPA6102A2 is a stereo audio power amplifier packaged in either an 8-pin SOIC package or an 8-pin MOSP package capable of delivering 50 mW of continuous RMS power per channel into 16-Ω loads. Amplifier gain is internally set to 14 dB (inverting) to save board space by eliminating six external resistors.

The TPA6102A2 is optimized for battery applications because of its low-supply current, shutdown current, and THD+N. To obtain the low-supply voltage range, the TPA6102A2 biases BYPASS to $V_{DD}/4$.

When driving a 16-Ω load with 40-mW output power from 3.3 V, THD+N is 0.08% at 1 kHz, and less than 0.2% across the audio band of 20 Hz to 20 kHz. For 30 mW into 32-Ω loads, the THD+N is reduced to less than 0.06% at 1 kHz, and is less than 0.3% across the audio band of 20 Hz to 20 kHz.

typical application circuit

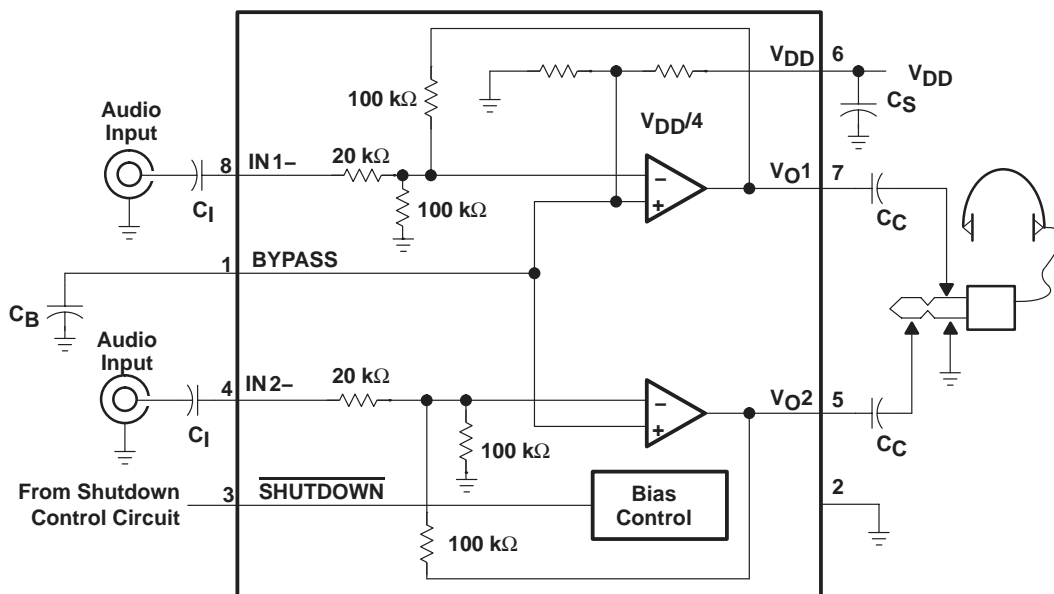

Please be aware that an important notice concerning availability, standard warranty, and use in critical applications of Texas Instruments semiconductor products and disclaimers thereto appears at the end of this data sheet.

PRODUCTION DATA information is current as of publication date. Products conform to specifications per the terms of Texas Instruments standard warranty. Production processing does not necessarily include testing of all parameters.

**TEXAS
INSTRUMENTS**

POST OFFICE BOX 655303 • DALLAS, TEXAS 75265

Copyright © 2004, Texas Instruments Incorporated

TPA6102A2
50-mW ULTRALOW-VOLTAGE, FIXED-GAIN STEREO HEADPHONE
AUDIO POWER AMPLIFIER

SLOS324B – JUNE 2000 – REVISED SEPTEMBER 2004

AVAILABLE OPTIONS

| T _A | PACKAGED DEVICE | | MSOP SYMBOLIZATION |
|----------------|-------------------|--------------|--------------------|
| | SMALL OUTLINE (D) | MSOP (DGK) | |
| -40°C to 85°C | TPA6102A2D | TPA6102A2DGK | AJN |

Terminal Functions

| TERMINAL NAME | NO. | I/O | DESCRIPTION |
|-----------------|-----|-----|--|
| BYPASS | 1 | I | Tap to voltage divider for internal mid-supply bias supply. BYPASS is set at V _{DD} /4. Connect to a 0.1-μF to 1-μF low ESR capacitor for best performance. |
| GND | 2 | I | GND is the ground connection. |
| IN1- | 8 | I | IN1- is the inverting input for channel 1. |
| IN2- | 4 | I | IN2- is the inverting input for channel 2. |
| SHUTDOWN | 3 | I | Active-low input. When held low, the device is placed in a low supply current mode. |
| V _{DD} | 6 | I | V _{DD} is the supply voltage terminal. |
| V _{O1} | 7 | O | V _{O1} is the audio output for channel 1. |
| V _{O2} | 5 | O | V _{O2} is the audio output for channel 2. |

absolute maximum ratings over operating free-air temperature (unless otherwise noted)†

| | |
|--|-----------------------------------|
| Supply voltage, V _{DD} | 4 V |
| Input voltage, V _I | -0.3 V to V _{DD} + 0.3 V |
| Continuous total power dissipation | Internally Limited |
| Operating junction temperature range, T _J | -40°C to 150°C |
| Storage temperature range, T _{stg} | -65°C to 150°C |
| Lead temperature 1,6 mm (1/16 inch) from case for 10 seconds | 260°C |

† Stresses beyond those listed under “absolute maximum ratings” may cause permanent damage to the device. These are stress ratings only, and functional operation of the device at these or any other conditions beyond those indicated under “recommended operating conditions” is not implied. Exposure to absolute-maximum-rated conditions for extended periods may affect device reliability.

DISSIPATION RATING TABLE

| PACKAGE | T _A ≤ 25°C POWER RATING | DERATING FACTOR ABOVE T _A = 25°C | T _A = 70°C POWER RATING | T _A = 85°C POWER RATING |
|---------|---------------------------------------|--|---------------------------------------|---------------------------------------|
| D | 710 mW | 5.68 mW/°C | 454 mW | 369 mW |
| DGK | 469 mW | 3.75 mW/°C | 300 mW | 244 mW |

recommended operating conditions

| | MIN | MAX | UNIT |
|--|-----------------------|-----|------|
| Supply voltage, V _{DD} | 1.6 | 3.6 | V |
| High-level input voltage, V _{IH} (SHUTDOWN) | 60% x V _{DD} | | V |
| Low-level input voltage, V _{IL} (SHUTDOWN) | 25% x V _{DD} | | V |
| Operating free-air temperature, T _A | -40 | 85 | °C |



TPA6102A2
50-mW ULTRALOW-VOLTAGE, FIXED-GAIN STEREO HEADPHONE
AUDIO POWER AMPLIFIER

SLOS324B – JUNE 2000 – REVISED SEPTEMBER 2004

dc electrical characteristics at $T_A = 25^\circ\text{C}$, $V_{DD} = 3.6\text{ V}$ (unless otherwise noted)

| PARAMETER | | TEST CONDITIONS | MIN | TYP | MAX | UNIT |
|---------------------|---|--|-----|------|-----|------------------|
| V_{OO} | Output offset voltage | $A_V = 14\text{ dB}$ | | 5 | 40 | mV |
| PSRR | Power supply rejection ratio | $V_{DD} = 3\text{ V to }3.6\text{ V}$ | | 72 | | dB |
| I_{DD} | Supply current | $\overline{\text{SHUTDOWN}} = 3.6\text{ V}$ | | 0.75 | 1.5 | mA |
| $I_{DD}(\text{SD})$ | Supply current in $\overline{\text{SHUTDOWN}}$ mode | $\overline{\text{SHUTDOWN}} = 0\text{ V}$ | | 50 | 250 | nA |
| $ I_{IH} $ | High-level input current ($\overline{\text{SHUTDOWN}}$) | $V_{DD} = 3.6\text{ V}$, $V_I = V_{DD}$ | | | 1 | μA |
| $ I_{IL} $ | Low-level input current ($\overline{\text{SHUTDOWN}}$) | $V_{DD} = 3.6\text{ V}$, $V_I = 0\text{ V}$ | | | 1 | μA |
| Z_I | Input impedance | | | 20 | | $\text{k}\Omega$ |

ac operating characteristics, $V_{DD} = 3.3\text{ V}$, $T_A = 25^\circ\text{C}$, $R_L = 16\ \Omega$

| PARAMETER | | TEST CONDITIONS | MIN | TYP | MAX | UNIT |
|-----------|--|---|-----|------|-----|---------------------------|
| G | Gain | | | 14 | | dB |
| P_O | Output power (each channel) | $\text{THD} \leq 0.1\%$, $f = 1\text{ kHz}$ | | 50 | | mW |
| THD+N | Total harmonic distortion + noise | $P_O = 45\text{ mW}$, $20\text{--}20\text{ kHz}$ | | 0.4% | | |
| B_{OM} | Maximum output power BW | $\text{THD} < 0.5\%$ | | > 20 | | kHz |
| k_{SVR} | Supply ripple rejection ratio | $f = 1\text{ kHz}$ | | 47 | | dB |
| SNR | Signal-to-noise ratio | $P_O = 50\text{ mW}$ | | 86 | | dB |
| V_n | Noise output voltage (no noise weighting filter) | | | 45 | | $\mu\text{V}(\text{rms})$ |

ac operating characteristics, $V_{DD} = 3.3\text{ V}$, $T_A = 25^\circ\text{C}$, $R_L = 32\ \Omega$

| PARAMETER | | TEST CONDITIONS | MIN | TYP | MAX | UNIT |
|-----------|--|---|-----|------|-----|---------------------------|
| G | Gain | | | 14 | | dB |
| P_O | Output power (each channel) | $\text{THD} \leq 0.1\%$, $f = 1\text{ kHz}$ | | 35 | | mW |
| THD+N | Total harmonic distortion + noise | $P_O = 30\text{ mW}$, $20\text{--}20\text{ kHz}$ | | 0.4% | | |
| B_{OM} | Maximum output power BW | $\text{THD} < 0.4\%$ | | > 20 | | kHz |
| k_{SVR} | Supply ripple rejection ratio | $f = 1\text{ kHz}$ | | 47 | | dB |
| SNR | Signal-to-noise ratio | $P_O = 30\text{ mW}$ | | 86 | | dB |
| V_n | Noise output voltage (no noise weighting filter) | | | 50 | | $\mu\text{V}(\text{rms})$ |

TPA6102A2

50-mW ULTRALOW-VOLTAGE, FIXED-GAIN STEREO HEADPHONE AUDIO POWER AMPLIFIER

SLOS324B – JUNE 2000 – REVISED SEPTEMBER 2004

dc electrical characteristics at $T_A = 25^\circ\text{C}$, $V_{DD} = 1.6\text{ V}$ (unless otherwise noted)

| PARAMETER | | TEST CONDITIONS | MIN | TYP | MAX | UNIT |
|---------------------|---|---|-----|------|-----|---------------|
| V_{OO} | Output offset voltage | $A_V = 14\text{ dB}$ | | 5 | 40 | mV |
| PSRR | Power supply rejection ratio | $V_{DD} = 1.4\text{ V to } 1.8\text{ V}$ | | 80 | | dB |
| I_{DD} | Supply current | $\overline{\text{SHUTDOWN}} = 1.6\text{ V}$ | | 0.65 | 1.2 | mA |
| $I_{DD}(\text{SD})$ | Supply current in SHUTDOWN mode | $\overline{\text{SHUTDOWN}} = 0\text{ V}$ | | 50 | 250 | nA |
| $ I_{IH} $ | High-level input current ($\overline{\text{SHUTDOWN}}$) | $V_{DD} = 1.6\text{ V}, V_I = V_{DD}$ | | | 1 | μA |
| $ I_{IL} $ | Low-level input current ($\overline{\text{SHUTDOWN}}$) | $V_{DD} = 1.6\text{ V}, V_I = 0\text{ V}$ | | | 1 | μA |
| Z_I | Input impedance | | | 20 | | k Ω |

ac operating characteristics, $V_{DD} = 1.6\text{ V}$, $T_A = 25^\circ\text{C}$, $R_L = 16\ \Omega$

| PARAMETER | | TEST CONDITIONS | MIN | TYP | MAX | UNIT |
|-----------|--|---------------------------------------|-----|--------|-----|---------------------------|
| G | Gain | | | 14 | | dB |
| P_O | Output power (each channel) | THD $\leq 0.5\%$, $f = 1\text{ kHz}$ | | 10 | | mW |
| THD+N | Total harmonic distortion + noise | $P_O = 9.5\text{ mW}$, 20–20 kHz | | 0.06% | | |
| B_{OM} | Maximum output power BW | THD $< 1\%$ | | > 20 | | kHz |
| k_{SVR} | Supply ripple rejection ratio | $f = 1\text{ kHz}$ | | 47 | | dB |
| SNR | Signal-to-noise ratio | $P_O = 10\text{ mW}$ | | 82 | | dB |
| V_n | Noise output voltage (no noise weighting filter) | | | 32 | | $\mu\text{V}(\text{rms})$ |

ac operating characteristics, $V_{DD} = 1.6\text{ V}$, $T_A = 25^\circ\text{C}$, $R_L = 32\ \Omega$

| PARAMETER | | TEST CONDITIONS | MIN | TYP | MAX | UNIT |
|-----------|--|---------------------------------------|-----|--------|-----|---------------------------|
| G | Gain | | | 14 | | dB |
| P_O | Output power (each channel) | THD $\leq 0.5\%$, $f = 1\text{ kHz}$ | | 7.5 | | mW |
| THD+N | Total harmonic distortion + noise | $P_O = 6.5\text{ mW}$, 20–20 kHz | | 0.05% | | |
| B_{OM} | Maximum output power BW | THD $< 1\%$ | | > 20 | | kHz |
| k_{SVR} | Supply ripple rejection ratio | $f = 1\text{ kHz}$ | | 47 | | dB |
| SNR | Signal-to-noise ratio | $P_O = 7.5\text{ mW}$ | | 84 | | dB |
| V_n | Noise output voltage (no noise weighting filter) | | | 32 | | $\mu\text{V}(\text{rms})$ |

TYPICAL CHARACTERISTICS

Table of Graphs

| | | FIGURE |
|-----------|--------------------------------------|--------------------|
| THD+N | Total harmonic distortion plus noise | vs Frequency |
| | | 1, 3, 5, 7, 9, 11 |
| | | vs Output power |
| | | 2, 4, 6, 8, 10, 12 |
| | | vs Output voltage |
| | | 13, 14 |
| P_O | Output power | vs Load resistance |
| | | 15, 16 |
| k_{SVR} | Supply ripple rejection ratio | vs Frequency |
| | | 17, 18 |
| V_n | Output noise voltage | vs Frequency |
| | | 19, 20 |
| | Crosstalk | vs Frequency |
| | | 21, 22 |
| | Closed-loop gain and phase | vs Frequency |
| | | 23, 24, 25, 26 |
| I_{DD} | Supply current | vs Supply voltage |
| | | 27 |
| P_D | Power dissipation | vs Output power |
| | | 28 |



TPA6102A2
50-mW ULTRALOW-VOLTAGE, FIXED-GAIN STEREO HEADPHONE
AUDIO POWER AMPLIFIER

SLOS324B – JUNE 2000 – REVISED SEPTEMBER 2004

TYPICAL CHARACTERISTICS

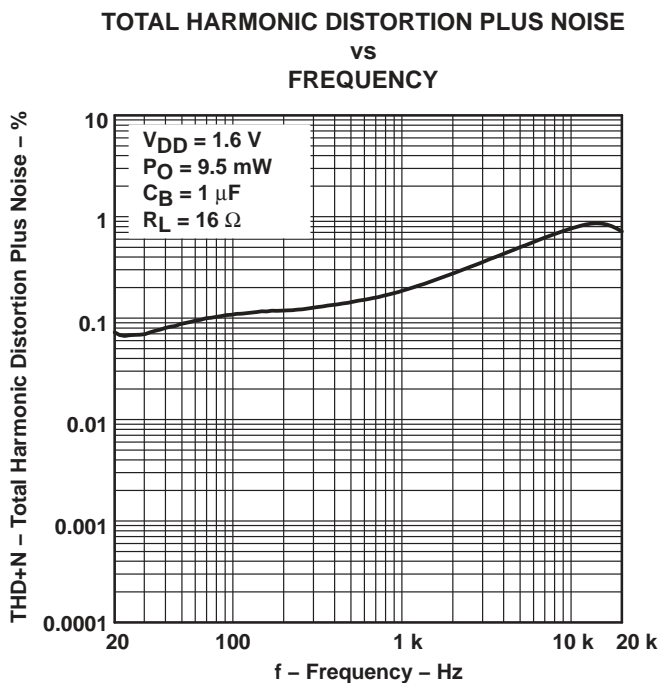

Figure 1

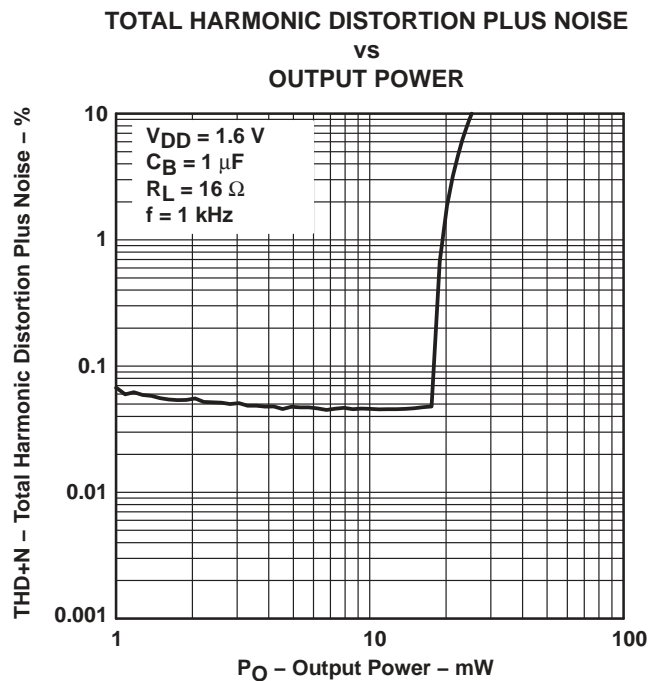

Figure 2

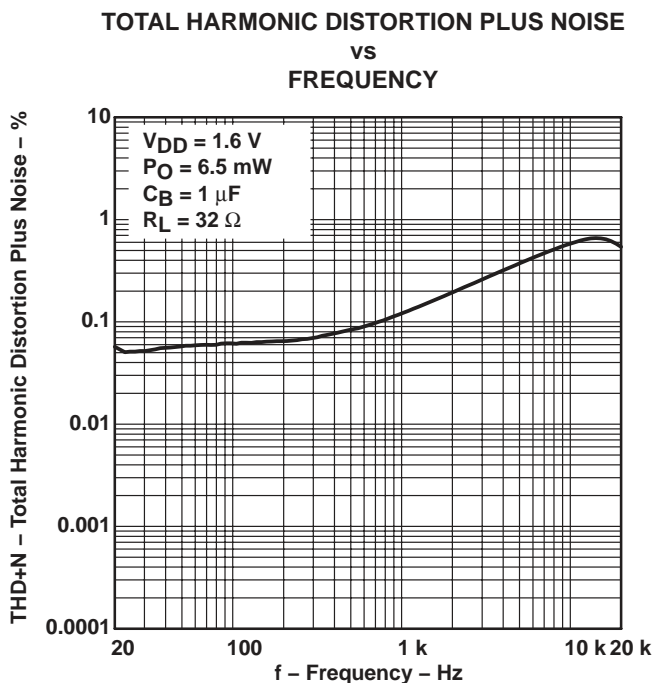

Figure 3

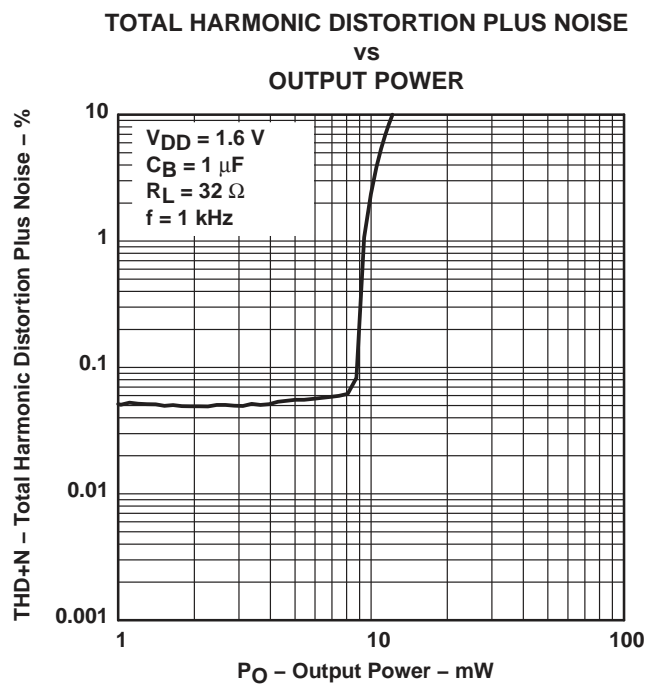

Figure 4

TYPICAL CHARACTERISTICS

TOTAL HARMONIC DISTORTION PLUS NOISE
VS
FREQUENCY

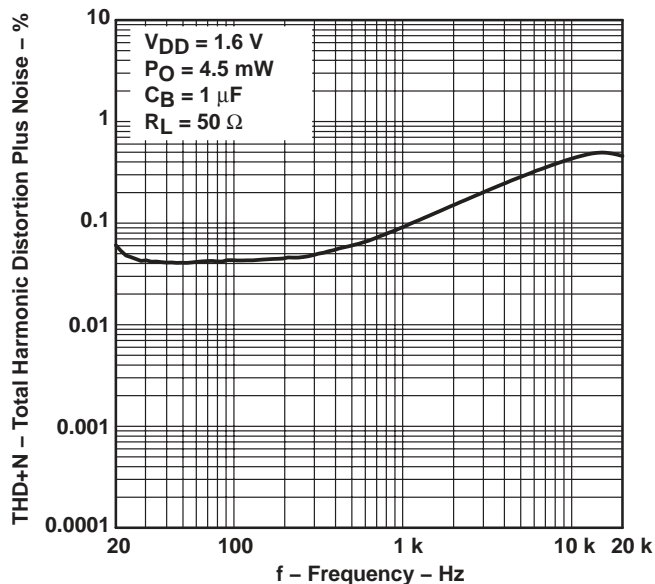

Figure 5

TOTAL HARMONIC DISTORTION PLUS NOISE
VS
OUTPUT POWER

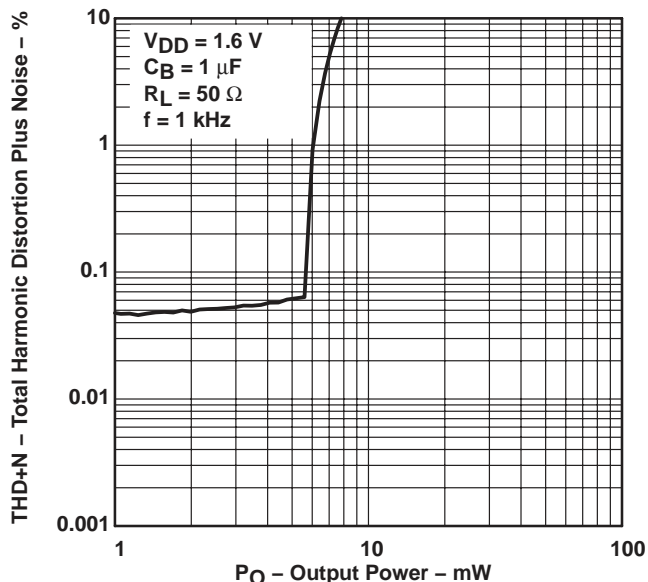

Figure 6

TOTAL HARMONIC DISTORTION PLUS NOISE
VS
FREQUENCY

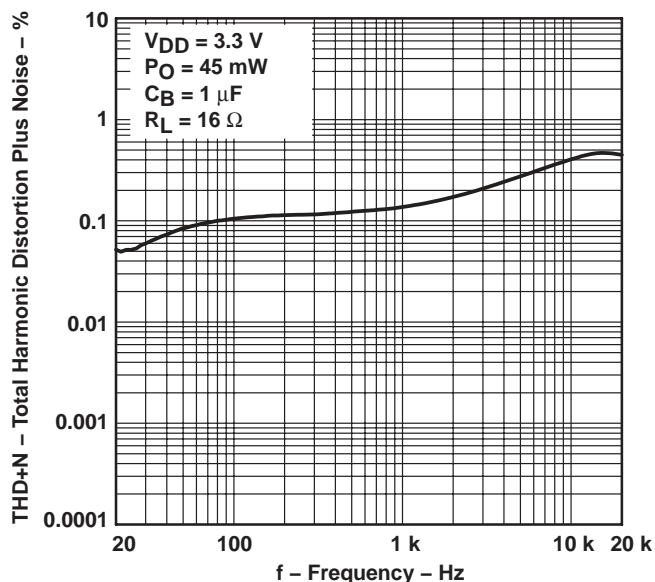

Figure 7

TOTAL HARMONIC DISTORTION PLUS NOISE
VS
OUTPUT POWER

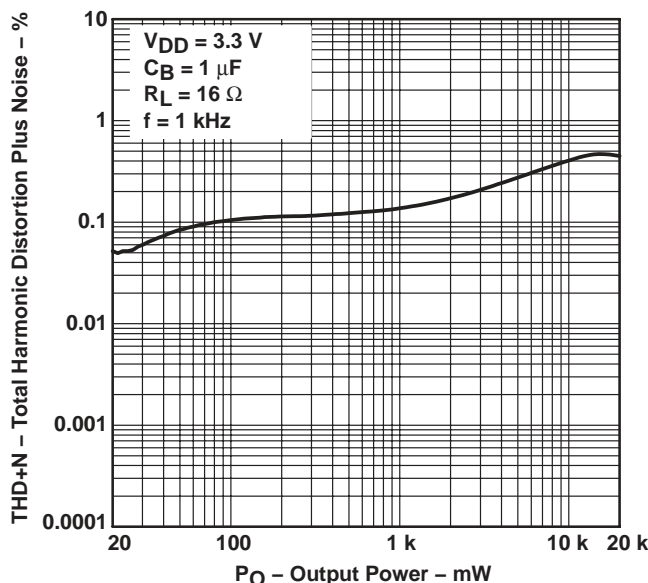

Figure 8

TPA6102A2
50-mW ULTRALOW-VOLTAGE, FIXED-GAIN STEREO HEADPHONE
AUDIO POWER AMPLIFIER

SLOS324B – JUNE 2000 – REVISED SEPTEMBER 2004

TYPICAL CHARACTERISTICS

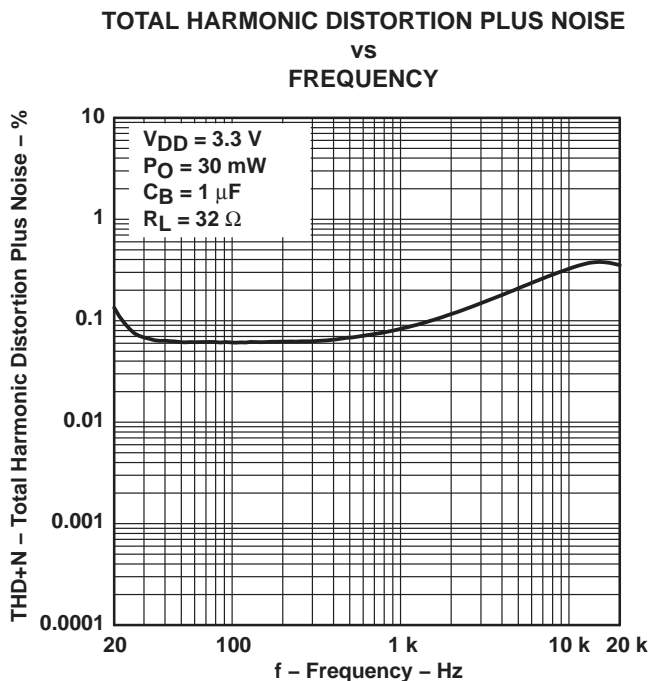

Figure 9

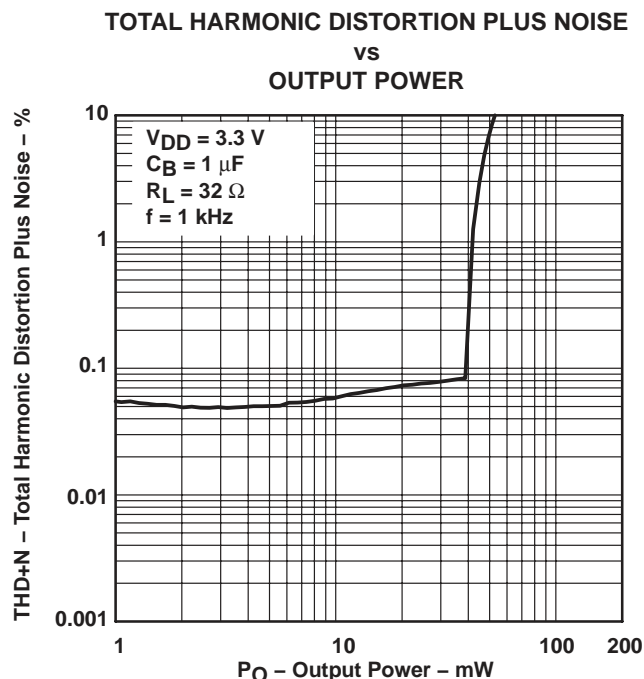

Figure 10

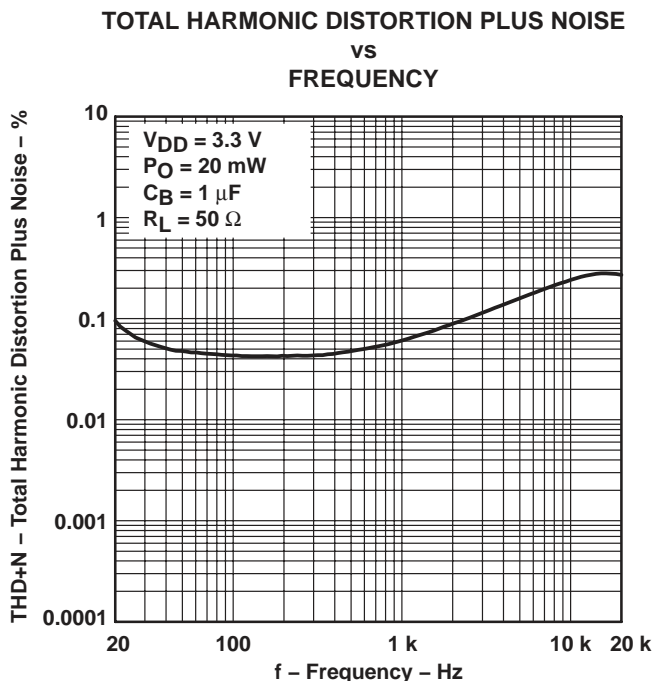

Figure 11

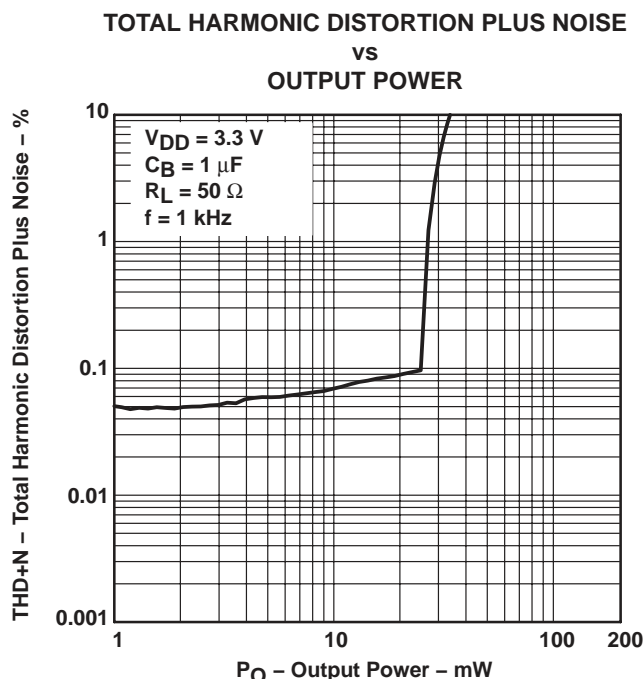

Figure 12

TYPICAL CHARACTERISTICS

TOTAL HARMONIC DISTORTION PLUS NOISE
vs
OUTPUT VOLTAGE

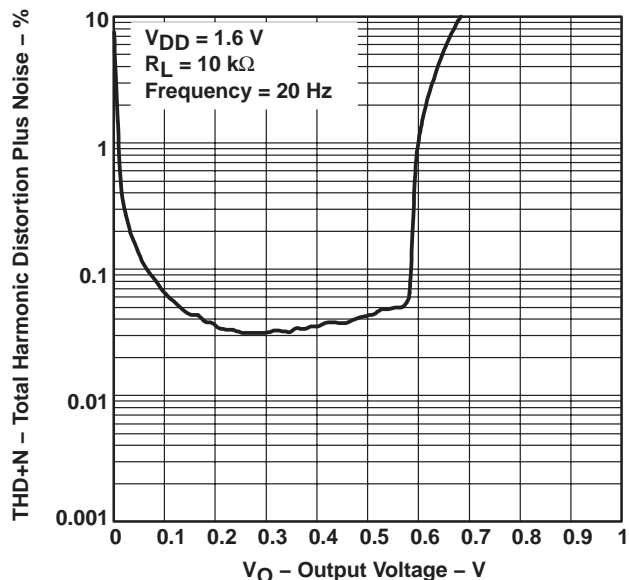

Figure 13

TOTAL HARMONIC DISTORTION PLUS NOISE
vs
OUTPUT VOLTAGE

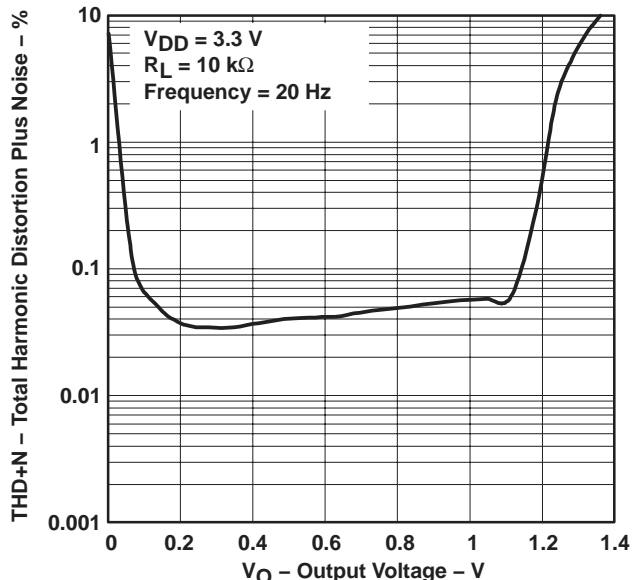

Figure 14

OUTPUT POWER
vs
LOAD RESISTANCE

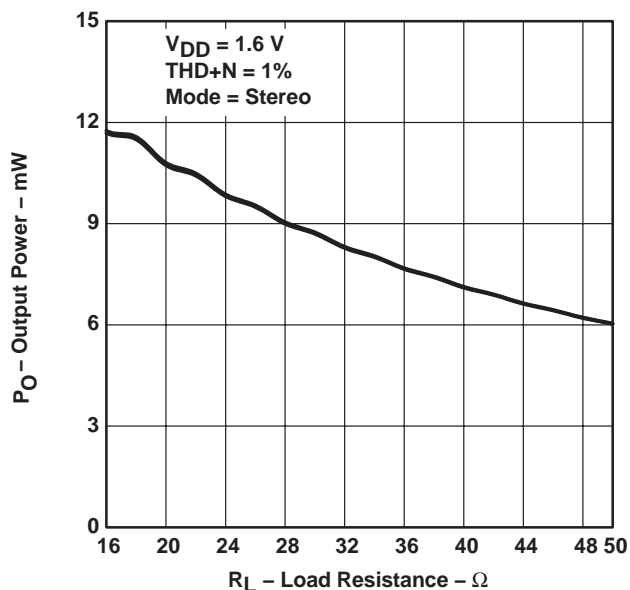

Figure 15

OUTPUT POWER
vs
LOAD RESISTANCE

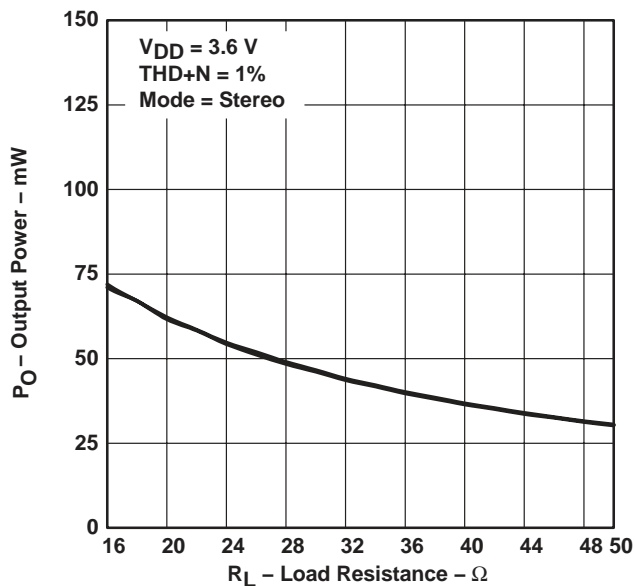
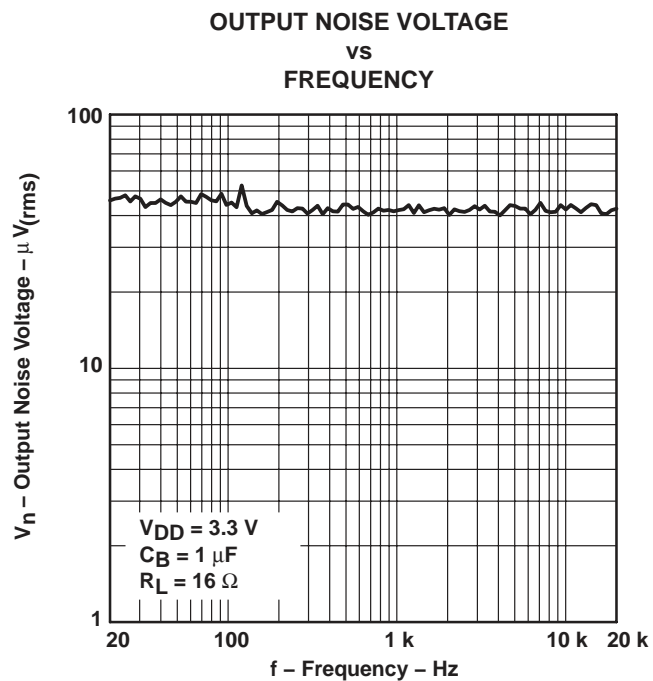
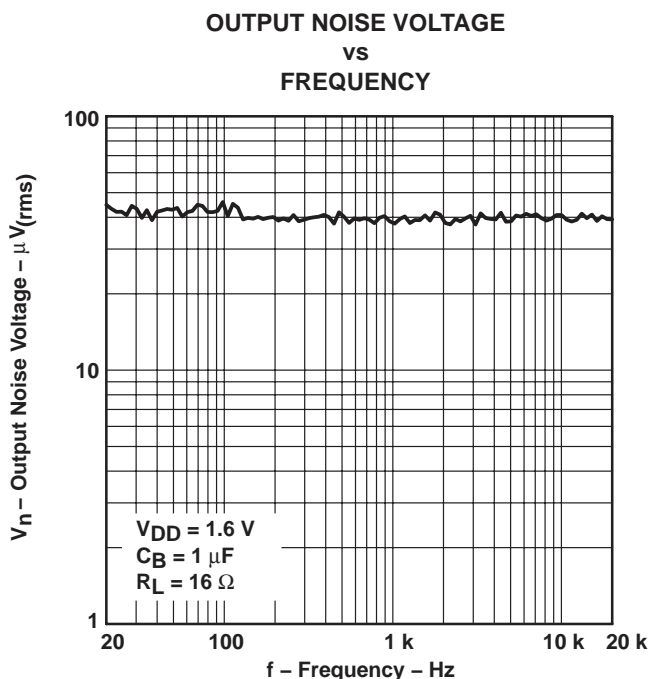
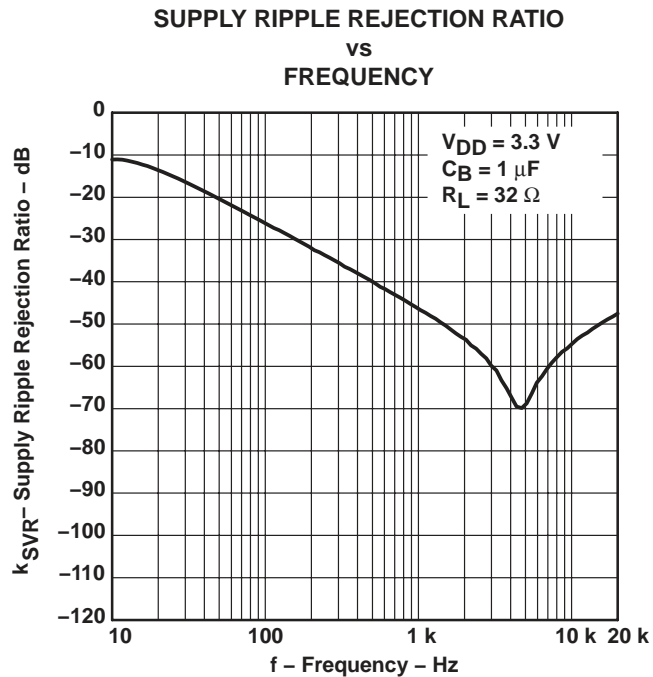
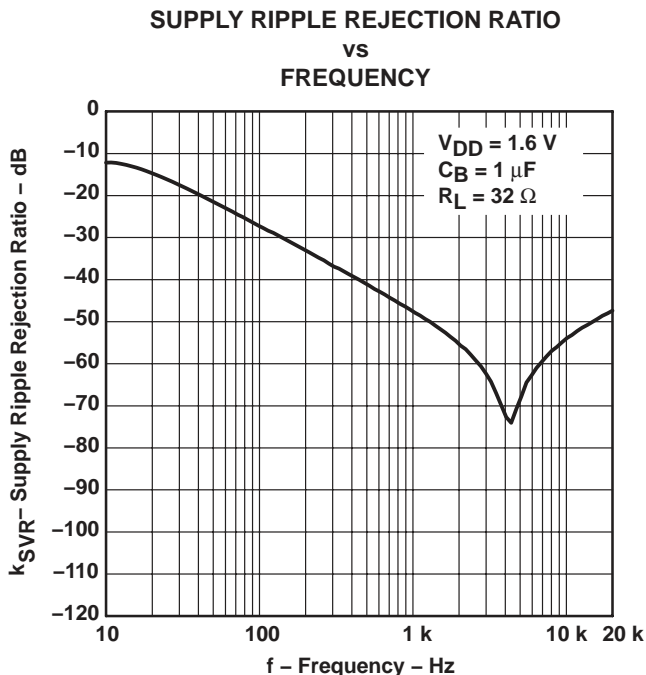

Figure 16

TPA6102A2
50-mW ULTRALOW-VOLTAGE, FIXED-GAIN STEREO HEADPHONE
AUDIO POWER AMPLIFIER

SLOS324B – JUNE 2000 – REVISED SEPTEMBER 2004

TYPICAL CHARACTERISTICS



TYPICAL CHARACTERISTICS

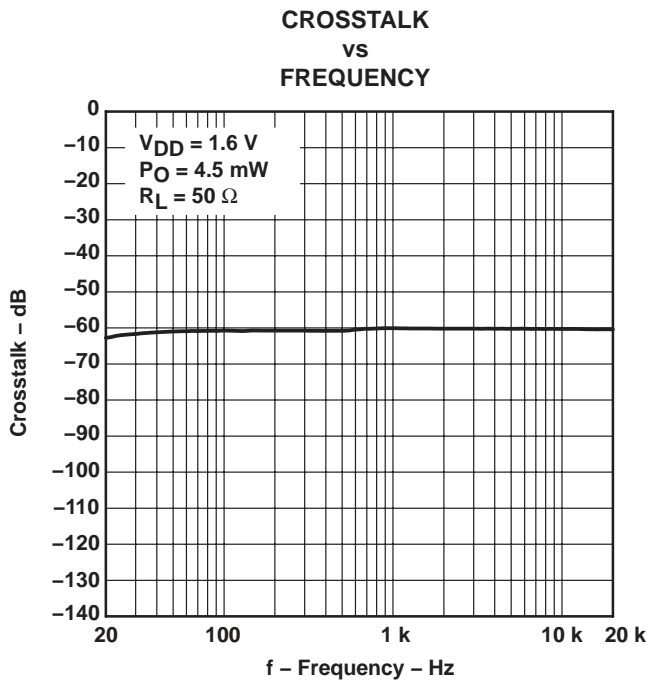

Figure 21

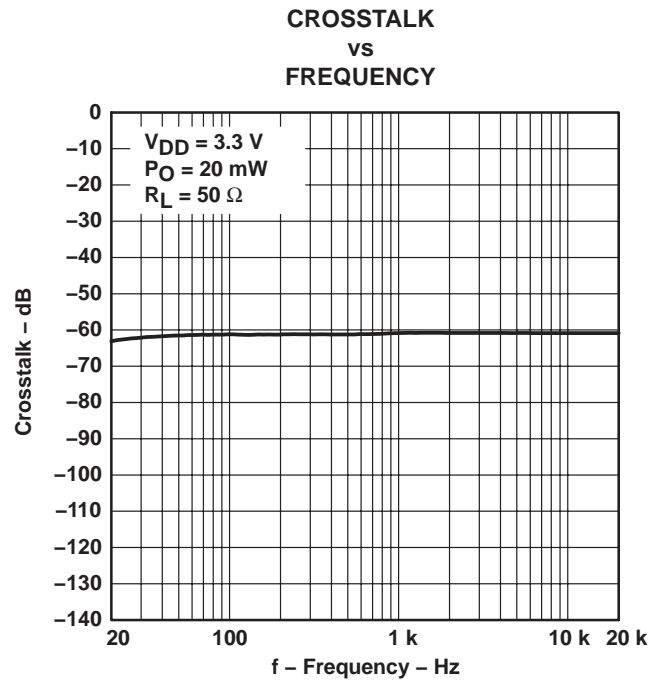

Figure 22

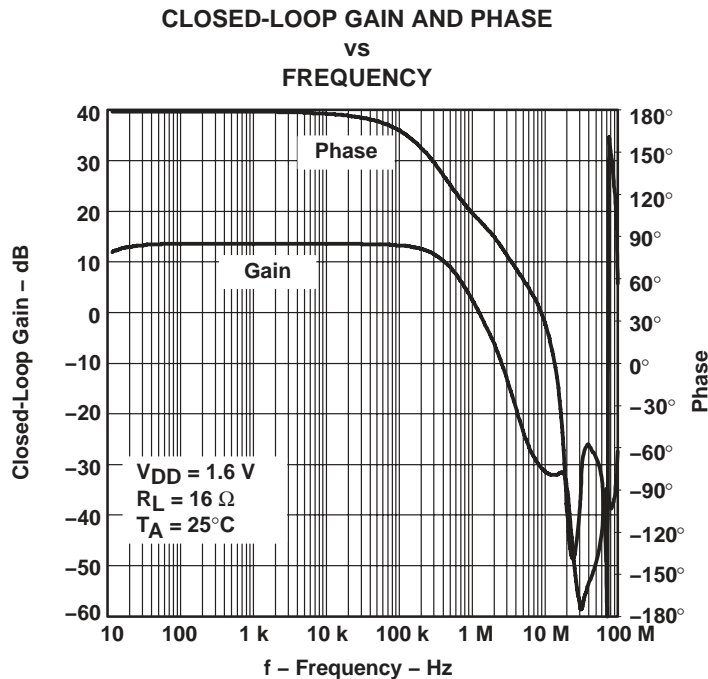

Figure 23

TYPICAL CHARACTERISTICS

CLOSED-LOOP GAIN AND PHASE
VS
FREQUENCY

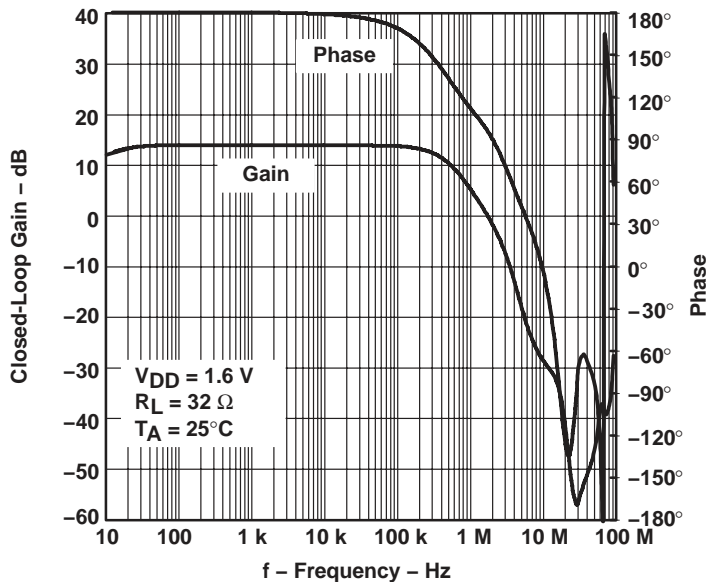

Figure 24

CLOSED-LOOP GAIN AND PHASE
VS
FREQUENCY

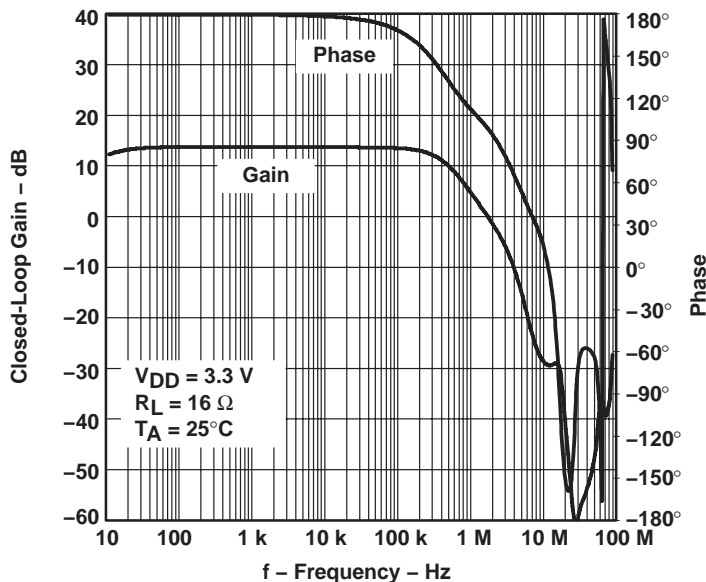

Figure 25

TYPICAL CHARACTERISTICS

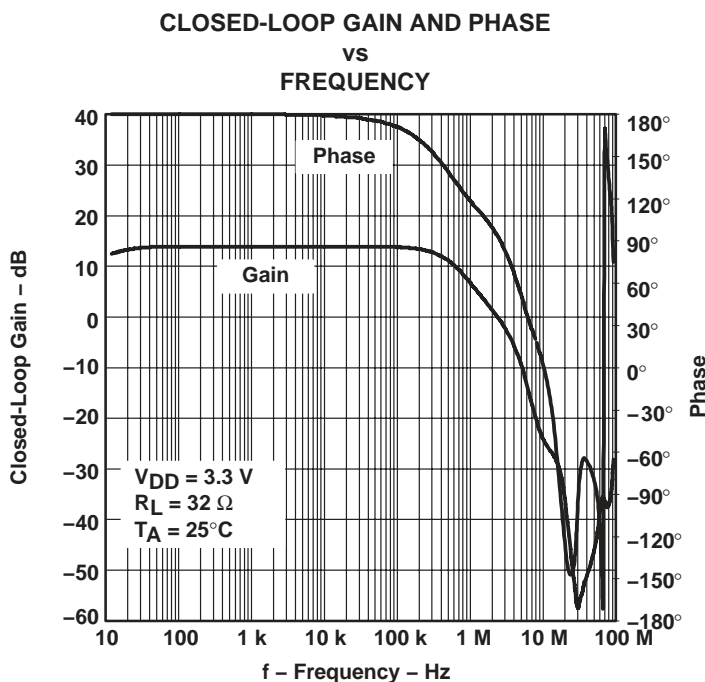

Figure 26

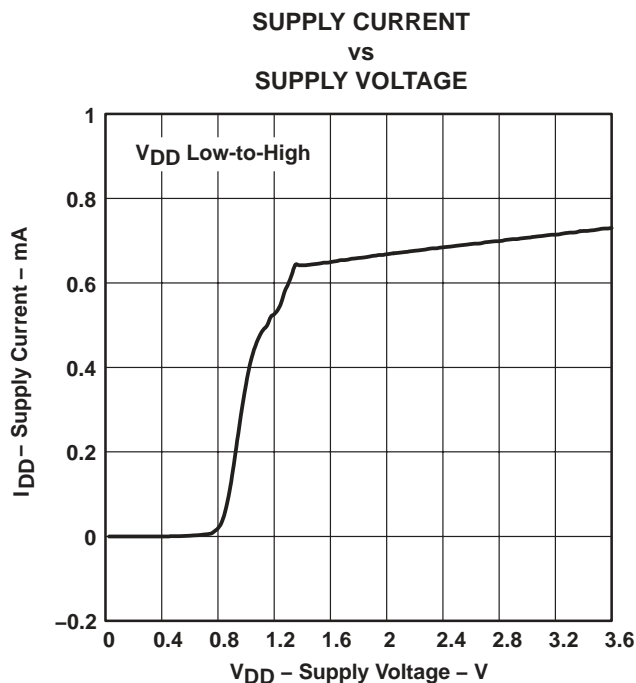

Figure 27

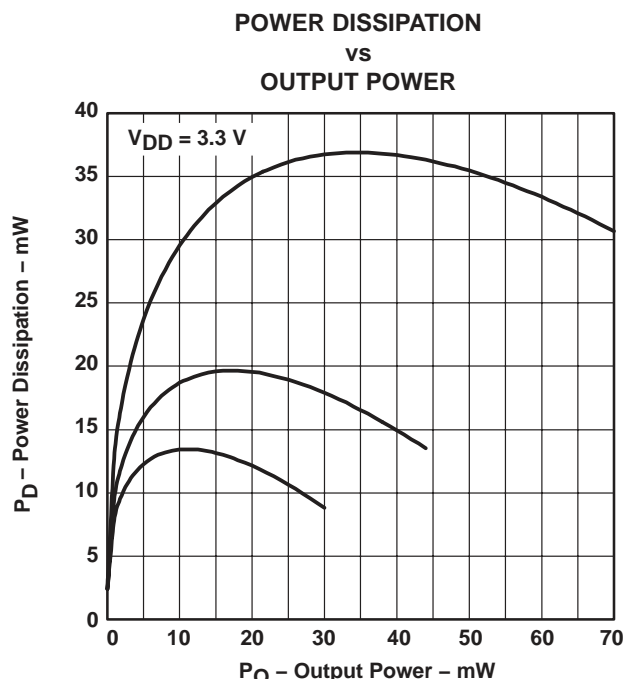

Figure 28

APPLICATION INFORMATION

input capacitor, C_I

In the typical application, an input capacitor (C_I) is required to allow the amplifier to bias the input signal to the proper dc level for optimum operation. In this case, C_I and R_I form a high-pass filter with the corner frequency determined in equation 1. R_I is set internally and is fixed at 20 k Ω .

$$f_c = \frac{1}{2\pi R_I C_I} \quad (1)$$

The value of C_I is important to consider, as it directly affects the bass (low frequency) performance of the circuit. Consider the example where the specification calls for a flat bass response down to 20 Hz. Equation 1 is reconfigured as equation 2.

$$C_I = \frac{1}{2\pi R_I f_c} \quad (2)$$

In this example, C_I is 0.40 μ F, so one would likely choose a value in the range of 0.47 μ F to 1 μ F. A further consideration for this capacitor is the leakage path from the input source through the input network (R_I , C_I) and the feedback resistor (R_F) to the load. This leakage current creates a dc offset voltage at the input to the amplifier that reduces useful headroom. For this reason a low-leakage tantalum or ceramic capacitor is the best choice. When polarized capacitors are used, the positive side of the capacitor should face the amplifier input in most applications, as the dc level there is held at $V_{DD}/4$, which is likely higher than the source dc level. It is important to confirm the capacitor polarity in the application.

power supply decoupling, C_S

The TPA6102A2 is a high-performance CMOS audio amplifier that requires adequate power supply decoupling to ensure that the output total harmonic distortion (THD) is as low as possible. Power supply decoupling also prevents oscillations for long lead lengths between the amplifier and the speaker. The optimum decoupling is achieved by using two capacitors of different types that target different types of noise on the power supply leads. For higher frequency transients, spikes, or digital hash on the line, a good low equivalent-series-resistance (ESR) ceramic capacitor, typically 0.1 μ F, placed as close as possible to the device V_{DD} lead, works best. For filtering lower-frequency noise signals, a larger aluminum electrolytic capacitor of 10 μ F or greater placed near the power amplifier is recommended.

midrail bypass capacitor, C_B

The midrail bypass capacitor (C_B) serves several important functions. During start-up, C_B determines the rate at which the amplifier starts up. This helps to push the start-up pop noise into the subaudible range (so low it can not be heard). The second function is to reduce noise produced by the power supply caused by coupling into the output drive signal. This noise is from the midrail generation circuit internal to the amplifier. The capacitor is fed from a 55-k Ω source inside the amplifier. To keep the start-up pop as low as possible, the relationship shown in equation 3 should be maintained.

$$\frac{1}{(C_B \times 55 \text{ k}\Omega)} \leq \frac{1}{(C_I R_I)} \quad (3)$$

As an example, consider a circuit where C_B is 1 μ F, C_I is 1 μ F, and R_I is 20 k Ω . Inserting these values into the equation 3 results in: $18.18 \leq 50$ which satisfies the rule. Bypass capacitor (C_B) with values of 0.47- μ F to 1- μ F ceramic or tantalum low-ESR capacitors are recommended for the best THD and noise performance.

APPLICATION INFORMATION

output coupling capacitor, C_C

In the typical single-supply single-ended (SE) configuration, an output coupling capacitor (C_C) is required to block the dc bias at the output of the amplifier, thus preventing dc currents in the load. As with the input coupling capacitor, the output coupling capacitor and impedance of the load form a high-pass filter governed by equation 4.

$$f_c = \frac{1}{2\pi R_L C_C} \quad (4)$$

The main disadvantage, from a performance standpoint, is that the typically small load impedances drive the low-frequency corner higher. Large values of C_C are required to pass low-frequencies into the load. Consider the example where a C_C of 68 μF is chosen and loads vary from 32 Ω to 47 k Ω . Table 1 summarizes the frequency response characteristics of each configuration.

Table 1. Common-Load Impedances vs Low-Frequency Output Characteristics in SE Mode

| R_L | C_C | Lowest Frequency |
|-----------------|------------------|------------------|
| 32 Ω | 68 μF | 73 Hz |
| 10,000 Ω | 68 μF | 0.23 Hz |
| 47,000 Ω | 68 μF | 0.05 Hz |

As Table 1 indicates, headphone response is adequate and drive into line level inputs (a home stereo for example) is very good.

The output-coupling capacitor required in single-supply SE mode also places additional constraints on the selection of other components in the amplifier circuit. With the rules described earlier still valid, add the following relationship:

$$\frac{1}{(C_B \times 55 \text{ k}\Omega)} \leq \frac{1}{(C_I R_I)} \ll \frac{1}{R_L C_C} \quad (5)$$

using low-ESR capacitors

Low-ESR capacitors are recommended throughout this application. A real capacitor can be modeled simply as a resistor in series with an ideal capacitor. The voltage drop across this resistor minimizes the beneficial effects of the capacitor in the circuit. The lower the equivalent value of this resistance, the more the real capacitor behaves like an ideal capacitor.

3.3-V versus 1.6-V operation

The TPA6102A2 was designed for operation over a supply range of 1.6 V to 3.6 V. There are no special considerations for 1.6-V versus 3.3-V operation as far as supply bypassing, gain setting, or stability. Supply current is slightly reduced from 0.75 mA (typical) to 0.65 mA (typical). The most important consideration is that of output power. Each amplifier can produce a maximum output voltage swing within a few hundred millivolts of the rails with a 10-k Ω load. However, this voltage swing decreases as the load resistance decreases and the $r_{DS(on)}$ as the output stage transistors becomes more significant. For example, for a 32- Ω load, the maximum peak output voltage with $V_{DD} = 1.6$ V is approximately 0.7 V with no clipping distortion. This reduced voltage swing effectively reduces the maximum undistorted output power.

PACKAGING INFORMATION

| Orderable Device | Status (1) | Package Type | Package Drawing | Pins | Package Qty | Eco Plan (2) | Lead finish/ Ball material (6) | MSL Peak Temp (3) | Op Temp (°C) | Device Marking (4/5) | Samples |
|------------------|---------------|--------------|-----------------|------|-------------|-----------------|--------------------------------------|----------------------|--------------|-------------------------|-------------------------|
| TPA6102A2D | ACTIVE | SOIC | D | 8 | 75 | RoHS & Green | NIPDAU | Level-1-260C-UNLIM | -40 to 85 | 6102A2 | Samples |
| TPA6102A2DGK | ACTIVE | VSSOP | DGK | 8 | 80 | RoHS & Green | NIPDAU | Level-1-260C-UNLIM | -40 to 85 | AJN | Samples |
| TPA6102A2DGKR | ACTIVE | VSSOP | DGK | 8 | 2500 | RoHS & Green | NIPDAU | Level-1-260C-UNLIM | -40 to 85 | AJN | Samples |

(1) The marketing status values are defined as follows:

ACTIVE: Product device recommended for new designs.

LIFEBUY: TI has announced that the device will be discontinued, and a lifetime-buy period is in effect.

NRND: Not recommended for new designs. Device is in production to support existing customers, but TI does not recommend using this part in a new design.

PREVIEW: Device has been announced but is not in production. Samples may or may not be available.

OBSOLETE: TI has discontinued the production of the device.

(2) **RoHS:** TI defines "RoHS" to mean semiconductor products that are compliant with the current EU RoHS requirements for all 10 RoHS substances, including the requirement that RoHS substance do not exceed 0.1% by weight in homogeneous materials. Where designed to be soldered at high temperatures, "RoHS" products are suitable for use in specified lead-free processes. TI may reference these types of products as "Pb-Free".

RoHS Exempt: TI defines "RoHS Exempt" to mean products that contain lead but are compliant with EU RoHS pursuant to a specific EU RoHS exemption.

Green: TI defines "Green" to mean the content of Chlorine (Cl) and Bromine (Br) based flame retardants meet JS709B low halogen requirements of <=1000ppm threshold. Antimony trioxide based flame retardants must also meet the <=1000ppm threshold requirement.

(3) MSL, Peak Temp. - The Moisture Sensitivity Level rating according to the JEDEC industry standard classifications, and peak solder temperature.

(4) There may be additional marking, which relates to the logo, the lot trace code information, or the environmental category on the device.

(5) Multiple Device Markings will be inside parentheses. Only one Device Marking contained in parentheses and separated by a "~" will appear on a device. If a line is indented then it is a continuation of the previous line and the two combined represent the entire Device Marking for that device.

(6) Lead finish/Ball material - Orderable Devices may have multiple material finish options. Finish options are separated by a vertical ruled line. Lead finish/Ball material values may wrap to two lines if the finish value exceeds the maximum column width.

Important Information and Disclaimer:The information provided on this page represents TI's knowledge and belief as of the date that it is provided. TI bases its knowledge and belief on information provided by third parties, and makes no representation or warranty as to the accuracy of such information. Efforts are underway to better integrate information from third parties. TI has taken and continues to take reasonable steps to provide representative and accurate information but may not have conducted destructive testing or chemical analysis on incoming materials and chemicals. TI and TI suppliers consider certain information to be proprietary, and thus CAS numbers and other limited information may not be available for release.

In no event shall TI's liability arising out of such information exceed the total purchase price of the TI part(s) at issue in this document sold by TI to Customer on an annual basis.

TAPE AND REEL INFORMATION

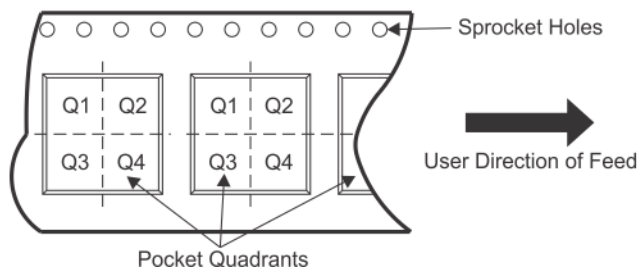
QUADRANT ASSIGNMENTS FOR PIN 1 ORIENTATION IN TAPE

*All dimensions are nominal

| Device | Package Type | Package Drawing | Pins | SPQ | Reel Diameter (mm) | Reel Width W1 (mm) | A0 (mm) | B0 (mm) | K0 (mm) | P1 (mm) | W (mm) | Pin1 Quadrant |
|---------------|--------------|-----------------|------|------|--------------------|--------------------|---------|---------|---------|---------|--------|---------------|
| TPA6102A2DGKR | VSSOP | DGK | 8 | 2500 | 330.0 | 12.4 | 5.3 | 3.4 | 1.4 | 8.0 | 12.0 | Q1 |

TAPE AND REEL BOX DIMENSIONS

*All dimensions are nominal

| Device | Package Type | Package Drawing | Pins | SPQ | Length (mm) | Width (mm) | Height (mm) |
|---------------|--------------|-----------------|------|------|-------------|------------|-------------|
| TPA6102A2DGKR | VSSOP | DGK | 8 | 2500 | 358.0 | 335.0 | 35.0 |

TUBE

*All dimensions are nominal

| Device | Package Name | Package Type | Pins | SPQ | L (mm) | W (mm) | T (μm) | B (mm) |
|------------|--------------|--------------|------|-----|--------|--------|--------|--------|
| TPA6102A2D | D | SOIC | 8 | 75 | 505.46 | 6.76 | 3810 | 4 |

D0008A



PACKAGE OUTLINE

SOIC - 1.75 mm max height

SMALL OUTLINE INTEGRATED CIRCUIT



4214825/C 02/2019

NOTES:

1. Linear dimensions are in inches [millimeters]. Dimensions in parenthesis are for reference only. Controlling dimensions are in inches. Dimensioning and tolerancing per ASME Y14.5M.
2. This drawing is subject to change without notice.
3. This dimension does not include mold flash, protrusions, or gate burrs. Mold flash, protrusions, or gate burrs shall not exceed .006 [0.15] per side.
4. This dimension does not include interlead flash.
5. Reference JEDEC registration MS-012, variation AA.

EXAMPLE BOARD LAYOUT

D0008A

SOIC - 1.75 mm max height

SMALL OUTLINE INTEGRATED CIRCUIT



LAND PATTERN EXAMPLE
 EXPOSED METAL SHOWN
 SCALE:8X



SOLDER MASK DETAILS

4214825/C 02/2019

NOTES: (continued)

- 6. Publication IPC-7351 may have alternate designs.
- 7. Solder mask tolerances between and around signal pads can vary based on board fabrication site.

EXAMPLE STENCIL DESIGN

D0008A

SOIC - 1.75 mm max height

SMALL OUTLINE INTEGRATED CIRCUIT



SOLDER PASTE EXAMPLE
BASED ON .005 INCH [0.125 MM] THICK STENCIL
SCALE:8X

4214825/C 02/2019

NOTES: (continued)

8. Laser cutting apertures with trapezoidal walls and rounded corners may offer better paste release. IPC-7525 may have alternate design recommendations.
9. Board assembly site may have different recommendations for stencil design.

DGK (S-PDSO-G8)

PLASTIC SMALL-OUTLINE PACKAGE

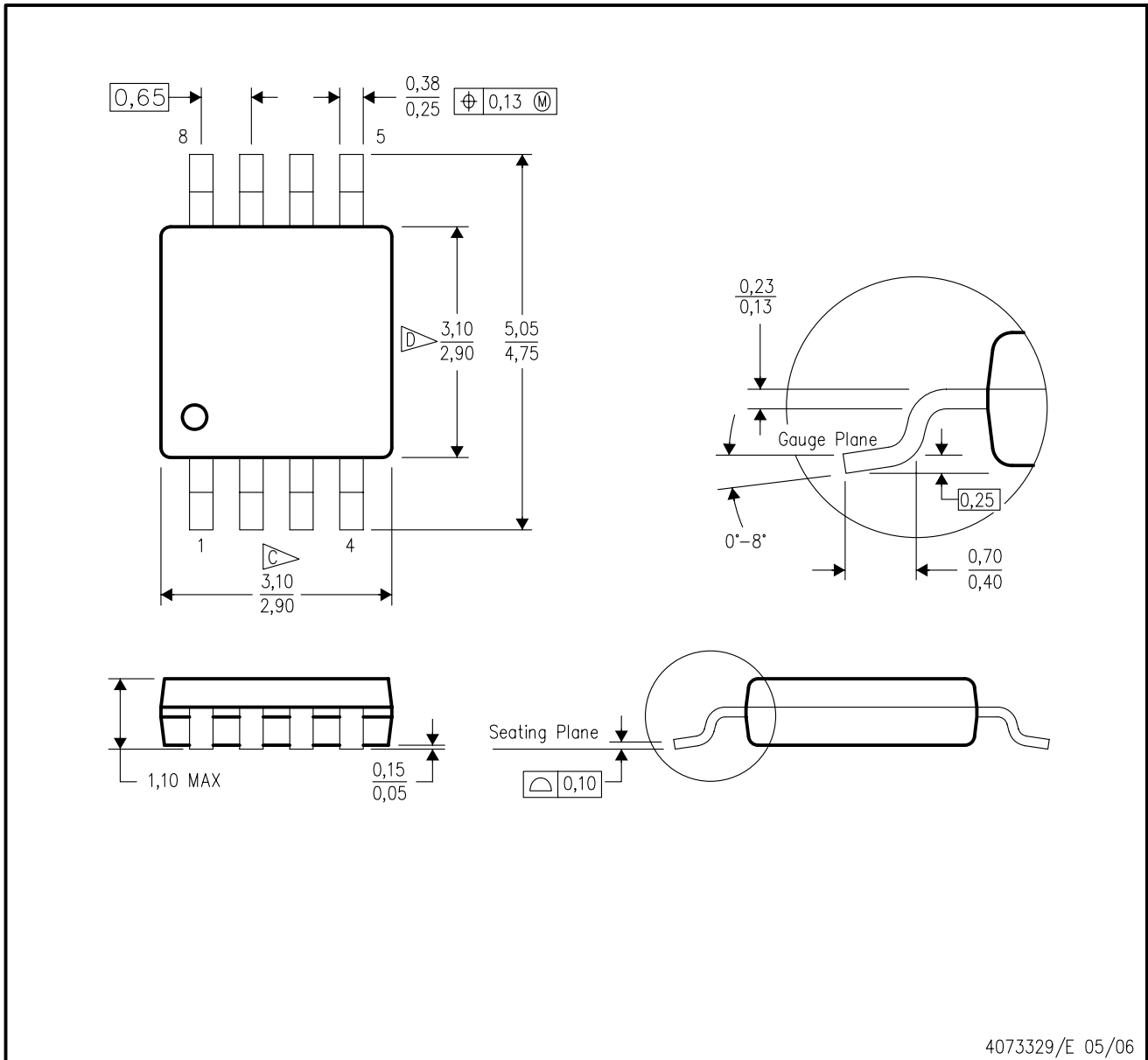

- NOTES:
- A. All linear dimensions are in millimeters.
 - B. This drawing is subject to change without notice.
 - C. Body length does not include mold flash, protrusions, or gate burrs. Mold flash, protrusions, or gate burrs shall not exceed 0.15 per end.
 - D. Body width does not include interlead flash. Interlead flash shall not exceed 0.50 per side.
 - E. Falls within JEDEC MO-187 variation AA, except interlead flash.



- NOTES:
- A. All linear dimensions are in millimeters.
 - B. This drawing is subject to change without notice.
 - C. Publication IPC-7351 is recommended for alternate designs.
 - D. Laser cutting apertures with trapezoidal walls and also rounding corners will offer better paste release. Customers should contact their board assembly site for stencil design recommendations. Refer to IPC-7525 for other stencil recommendations.
 - E. Customers should contact their board fabrication site for solder mask tolerances between and around signal pads.

IMPORTANT NOTICE AND DISCLAIMER

TI PROVIDES TECHNICAL AND RELIABILITY DATA (INCLUDING DATA SHEETS), DESIGN RESOURCES (INCLUDING REFERENCE DESIGNS), APPLICATION OR OTHER DESIGN ADVICE, WEB TOOLS, SAFETY INFORMATION, AND OTHER RESOURCES "AS IS" AND WITH ALL FAULTS, AND DISCLAIMS ALL WARRANTIES, EXPRESS AND IMPLIED, INCLUDING WITHOUT LIMITATION ANY IMPLIED WARRANTIES OF MERCHANTABILITY, FITNESS FOR A PARTICULAR PURPOSE OR NON-INFRINGEMENT OF THIRD PARTY INTELLECTUAL PROPERTY RIGHTS.

These resources are intended for skilled developers designing with TI products. You are solely responsible for (1) selecting the appropriate TI products for your application, (2) designing, validating and testing your application, and (3) ensuring your application meets applicable standards, and any other safety, security, regulatory or other requirements.

These resources are subject to change without notice. TI grants you permission to use these resources only for development of an application that uses the TI products described in the resource. Other reproduction and display of these resources is prohibited. No license is granted to any other TI intellectual property right or to any third party intellectual property right. TI disclaims responsibility for, and you will fully indemnify TI and its representatives against, any claims, damages, costs, losses, and liabilities arising out of your use of these resources.

TI's products are provided subject to [TI's Terms of Sale](#) or other applicable terms available either on ti.com or provided in conjunction with such TI products. TI's provision of these resources does not expand or otherwise alter TI's applicable warranties or warranty disclaimers for TI products.

TI objects to and rejects any additional or different terms you may have proposed.

Mailing Address: Texas Instruments, Post Office Box 655303, Dallas, Texas 75265
Copyright © 2022, Texas Instruments Incorporated